



COMPONENTES GAS



COMPONENTES ELÉCTRICOS



TECNOLOGÍA DEL AGUA



COMPONENTES MECÁNICOS



HERRAMIENTAS

Repuestos adaptables a

SCOTSMAN

Encuentre nuestra gama siempre actualizada en la tienda online de GEV



Catálogo de fabricantes

Las piezas de repuesto y accesorios más importantes de cada fabricante reunidas y ordenadas de manera práctica

- ✓ En la tienda online GEV encontrará el surtido completo y toda la información actualizada de máquinas y aparatos
- ✓ Índice alfabético al final del catálogo

Tienda online GEV

www.gev-online.es
www.gev-online.com



- 🔍 marcar artículos como favoritos
- 🔍 acceso mediante su e-mail y su contraseña habitual
- 🔍 ponga en la cesta de la compra, múltiples artículos a la vez
- 🔍 búsqueda de artículos inmediata sin necesidad conectarse

termostatos

termostatos de control y seguridad

RANCO

termostatos de seguridad



código	375832	referencia	62044300 62044302
descripción	termostato de seguridad T máx 70°C margen de trabajo 0-70°C 1 polos 1NO 16A sonda ø 8mm sonda L 60mm capilar 870mm aislamiento del capilar mm prensaestopas eje ømm eje Lmm posición del eje ángulo de rotación° material de bulbo cobre temp. desconexión 70°C		
Para modelos:	Barline-20, Barline-21, Barline-30, Barline-31, Barline-40, Barline-50, Barline-65, Barline-90, ICE-ONE, ICE-THREE, ICE-TWO, SD18		

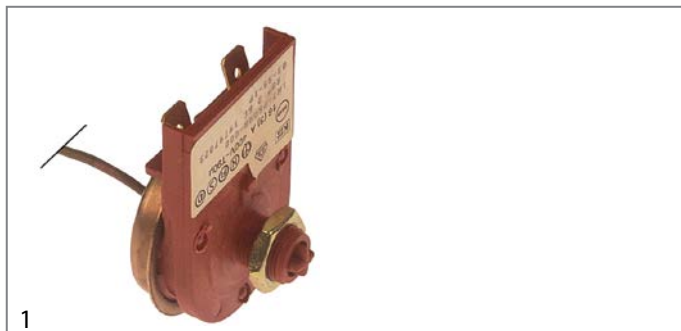

código	390583	referencia	CM19797023
descripción	termostato de seguridad T máx 80°C margen de trabajo °C 1 polos 1NC 16A sonda ø 9mm sonda L 50mm capilar 800mm aislamiento del capilar mm prensaestopas eje ømm eje Lmm posición del eje ángulo de rotación° material de bulbo cobre con sensor unión roscada M10x0,75 temp. desconexión 80°C		

termostatos para frío

DANFOSS

termostatos de servicio DANFOSS

Todos los termostatos de Danfoss se suministran con material de fijación

aplicaciones:

- 390552 - **frigorífico (a -12 °C)
- 390553 - **frigorífico (a -12 °C) con tecla descongelación
- 390554 - **/**frigorífico (a -12 °/-18°C) con desconge. auto.
- 390555 - frigorífico assorbinento
- 390557 - equipo remoto señal activa
- 390558 - equipo remoto señal pasiva
- 390559 - botellero y bebidas frías



código	390559	referencia	19797007 CM19797007 CM19797012
descripción	termóstato tipo 077B7008 capilar 2000mm margen de trabajo -8,5 a +11,5°C sonda ømm sonda Lmm		

RANCO

serie K22



código	390207	referencia	62026414
descripción	termóstato RANCO tipo K22L2030 sonda ø 2mm sonda Lmm capilar 2000mm margen de trabajo -13 a -4°C		

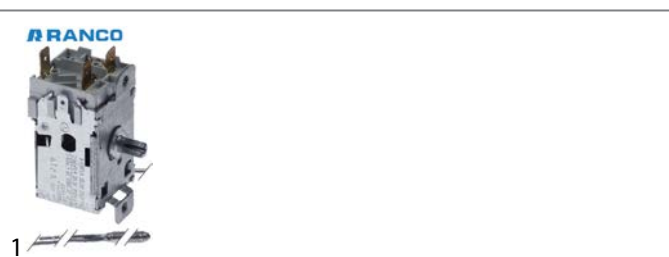

código	390646	referencia	62026303
descripción	termóstato RANCO tipo K22-L1075 capilar 2900mm bulbo ø9,5x-107mm		
Para modelos:	MAR125, MF102, MF82, MF83		

RANCO



1

código	390644	referencia	1100052121
descripción	termóstato RANCO tipo A22-1297-000 capilar 1500mm bulbo ø10x100mm		

RANCO



1

código	390209	referencia	62020100
descripción	termóstato RANCO tipo K22L1020 sonda ø 9mm sonda L 40mm capilar 2000mm margen de trabajo -20,5 a -1,5°C		
Para modelos:	ACM85		

RANCO



1

código	390737	referencia	62020101
descripción	termóstato RANCO tipo K22-L1074 sonda ø 9mm sonda L 42mm capilar 1450mm margen de trabajo -19 a -1°C		
Para modelos:	Barline-50, Barline-65, Barline-90		

RANCO



1

código	390277	referencia	63003800
descripción	termóstato RANCO tipo K22L3020 sonda ø 9mm sonda L 40mm capilar 1600mm margen de trabajo -26,5 a -19,5°C		

RANCO



1

código	390280	referencia	62012500
descripción	termóstato RANCO tipo K22L3021 sonda ø 9mm sonda L 35mm capilar 1600mm margen de trabajo -14 a -9°C		

RANCO



1

código	390279	referencia	62012900
descripción	termóstato RANCO tipo K22L3022 sonda ø 9mm sonda L 35mm capilar 1600mm		

serie K50

RANCO



1

código	390208	referencia	620209.00
descripción	termóstato RANCO tipo K50L3006 sonda ømm sonda Lmm capilar 2000mm margen de trabajo +1,5 F7820 +4°C		

RANCO



1

código	390254	referencia	62020900
descripción	termóstato RANCO tipo K50P1135 sonda ømm sonda Lmm capilar 2500mm T fría 1.5°C		



código	390581	referencia	19797026 62020900 63000500
descripción	termóstato RANCO tipo K50-S3595 sonda ø 2mm sonda Lmm capilar 2000mm		
Para modelos:	AC046, AC056, AC086, ACM35, ACM55, ACM85, AF10, Barline-20, Barline-21, Barline-30, Barline-31, Barline-40, Barline-50, Barline-65, Barline-90, ICE-ONE, ICE-THREE, ICE-TWO, MF82, SD18		



código	390284	referencia	CM19797018
descripción	termóstato RANCO tipo K55L5082 capilar 1500mm margen de trabajo °C bulbo ø10x110mm		



código	390444	referencia	62026300
descripción	termóstato RANCO tipo K50-L3074 sonda ø 9mm sonda L 40mm capilar 560mm		
Para modelos:	ACM25		

serie K61



código	390212	referencia	620264.01 62026410
descripción	termóstato RANCO tipo K61L1500 sonda ømm sonda Lmm capilar 750mm T caliente -11.5°C T fría 22°C		
Para modelos:	ACM25, ACM35		

serie K55



código	390210	referencia	62026302
descripción	termóstato RANCO tipo K55L1042 capilar 1100mm margen de trabajo +1,7 a +9,5°C bulbo ø10x110mm		



código	390206	referencia	620264.00
descripción	termóstato RANCO tipo K61L1501 sonda ømm sonda Lmm capilar 1800mm		



código	390283	referencia	CM19797017
descripción	termóstato RANCO tipo K55L5081 capilar 1100mm margen de trabajo °C bulbo ø10x110mm		



código	390586	referencia	620264-11
descripción	termóstato RANCO tipo K61L1504 sonda ø 2mm sonda Lmm capilar 1800mm T caliente 11.5°C T fría 22°C		
Para modelos:	AC086, Barline-20, Barline-30, Barline-40, ICE-ONE, ICE-THREE, ICE-TWO		



RANCO



1

código	379516	referencia	62026402 62026416
descripción	termóstato RANCO tipo K61L1508 sonda ø 2mm sonda Lmm capilar 1800mm		
Para modelos:	AC046, AC056, ACM35, ACM55, Barline-20, Barline-21, Barline-31, ICE-ONE, ICE-TWO		

RANCO



1

código	390591	referencia	62026415
descripción	termóstato RANCO tipo K61L1509 sonda ø 2mm sonda Lmm capilar 2250mm		
Para modelos:	SD18		

otros fabricantes



1

código	390485	referencia	1100035323 11035323
descripción	termóstato		
Para modelos:	AC30		



1

código	390659	referencia	1100036600 11-0366-00
descripción	termóstato sonda ø 2.5mm capilar 90mm		

accesorios

clips para bulbo

otros



1

código	695858	referencia	66033900
descripción	abrazadera L 24mm ø 15mm H 8mm montaje ø 6mm para tubo		
Para modelos:	ACM25		

interruptores y pulsadores

interruptores/pulsadores basculantes

25,5x25mm



1

código	301245 ¹	referencia	33400025 CM33400025
descripción	interruptor basculante medida de montaje 25,5x25mm blanco 2NO 250V 16A 0-I empalme conector Faston 6,3mm protección IP40		

¹iluminado

30x11mm



1

código	301013	referencia	62044201 62044202
descripción	interruptor basculante medida de montaje 30x11mm negro 1CO 250V 16A empalme conector Faston 6,3mm temperatura ambiente máx. 85/125°C protección IP40		
Para modelos:	AC046, AC056, AC086, Barline-20, Barline-21, Barline-30, Barline-31, Barline-40, Barline-50, Barline-65, Barline-90, ICE-ONE, ICE-THREE, ICE-TWO, SD18		

30x22mm



1

código	347074	referencia	63011300
descripción	interruptor basculante medida de montaje 30x22mm negro/naranja 1NO/lámpara 250V 16A frío empalme conector Faston 6,3mm temperatura ambiente máx. 125/55°C protección IP65 con tapa		
Para modelos:	MAR125, MF82, MF83		



otros			
1			
código	347064	referencia	1105351 1200241101
descripción	interruptor basculante medida de montaje 40x18mm negro 1CO 250V 10A		
accesorios para	347064		
	código	694188	referencia 1200240201 4217037
	mazo de cables 3 polos L 170mm temperatura constante 105°C tipo de conector Faston 6,3mm		

1			
código	346516	referencia	62003300
descripción	interruptor de palanca rosca M12x0,75 1NO 250V 15A ON-OFF conector Faston 6,3mm		
Para modelos:	ACM35, ACM55, ACM85, AF10, AF20, AF30		

1			
código	346520	referencia	33400019 CM33400019
descripción	interruptor de palanca rosca M12x0,75 2CO 250V 15A ON-OFF-ON conector Faston 6,3mm con posición neutra T máx 85/55°C		
Para modelos:	MV18, MV25		

interruptores pulsantes y pulsadores

19x13mm			
1			
código	346871 ¹	referencia	62048702
descripción	interruptor pulsante medida de montaje 19x13mm verde 2NO 250V 16A iluminado empalme conector Faston 4,8mm temperatura ambiente máx. 105/55°C protección IP40		
Para modelos:	AC046, AC056, AC086, AC106, AC126, AC176, AC226		
accesorios para	346871		
	código	346541	referencia —
	cubierta protectora para interruptor basculante dimensiones exteriores 23,4x17,4mm dimensión interior 19x13mm H 9,5mm medida de montaje mm		

1			
código	347068	referencia	33400027 CM33400027
descripción	interruptor de palanca rosca M12x0,75 2NO 250V 16A ON-OFF-ON conector Faston 6,3mm con posición neutra		
Para modelos:	MV18, MV25, MV50		

¹iluminado

1			
código	347079 ¹	referencia	1105324 62048700
descripción	interruptor pulsante medida de montaje 19x13mm verde 2NO 250V 16A iluminado empalme conector Faston 6,3mm temperatura ambiente máx. 125°C protección IP65 con tapa		
Para modelos:	AC046, AC056, AC086, AC106, AC126, AC176, AC226, MC8		

¹iluminado

interruptor de palanca

M12x0,75			
1			
código	346526	referencia	62003302
descripción	interruptor de palanca rosca M12x0,75 1CO 250V 15A ON-ON conector Faston 6,3mm		

microinterruptores

accionado por palanca

1			
código	347063	referencia	25474581 CM25474581
descripción	microinterruptor 250V 15A 1CO empalme conector Faston 6,3mm temperatura ambiente máx. 105°C longitud de palanca 37mm		

1			
código	345345	referencia	CM19410207
descripción	microinterruptor con manilla 250V 16A 1CO empalme conector Faston 6,3mm L 78mm temperatura ambiente máx. 85°C distancia de sujeción 22mm tipo X662-88-J27 fuerza de accionamiento: 40g longitud de palanca 69mm		

1			
código	345107	referencia	62025700 T00204
descripción	microinterruptor con manilla 250V 16A 1CO empalme conector Faston 6,3mm L 98mm temperatura ambiente máx. 125°C distancia de sujeción 22mm fuerza de accionamiento: 30g longitud de palanca 90mm		



			
1			
código	345044	referencia	620033.02
descripción	microinterruptor con manilla 250V 16A 1CO empalme conector Faston 6,3mm temperatura ambiente máx. 85°C distancia de sujeción 25mm tipo C99ZP3 fuerza de accionamiento: 25g longitud de palanca 71mm		

			
1			
código	346887	referencia	1107144S&P 1200205901 12205901
descripción	microinterruptor con manilla 250V 15A 1NC empalme conector Faston 6,3mm temperatura ambiente máx. 125°C longitud de palanca 60mm		
Para modelos:	AF10, AF1D, AF20, AF30, AF300, AF325, AF430, AFE325AE-1A, AFE325AE-6A, AFE325AS-1A, AFE325AS-1B, AFE325AS-6A, AFE325AS-6B, AFE400, FD470, FD4D, FD5C, FDE470AE-1A, FDE470AE-6A, FDE470AS-1A, FDE470AS-6A, FDE474AS-1A, FDE474AS-6A, MF400AE-1A, MF400AE-1B, MFE400, TDE470AE-1A, TDE470AE-6A, TDE470AS-1A, TDE470AS-6A		

			
1			
código	347077	referencia	1200164100
descripción	microinterruptor con manilla 250V 15A 2CO empalme conector Faston 6,3mm temperatura ambiente máx. 85°C longitud de palanca 62mm		

			
1			
código	345361	referencia	CM19410205
descripción	microinterruptor con manilla 250V 5A 1NO/1NC empalme conexión para soldadura temperatura ambiente máx. 85°C tipo 83109004 longitud de palanca 43mm		

accionados por palanca de rodillo

microinterruptores

			
1			
código	345253	referencia	CM19410209
descripción	microinterruptor con palanca de rodillo 250V 15A 1CO empalme conector Faston 6,3mm L 28mm L1 37mm temperatura ambiente máx. 125°C distancia de sujeción 22mm tipo RL6-1-F-GE-P12-5-L fuerza de accionamiento: 80g gris longitud de palanca 28mm		

versión pesada

			
1			
código	346874	referencia	CM19410300
descripción	microinterruptor con palanca de rodillo 250V 16A 1CO empalme atornillado L 29mm L1 49mm temperatura ambiente máx. 85°C distancia de sujeción 26mm tipo Z-15GW22-B fuerza de accionamiento: 120g longitud de palanca 25mm		

con piezas de montaje

			
1			
código	346876	referencia	CM19410208
descripción	microinterruptor con palanca de rodillo 250V 16A 1CO empalme conector Faston L 35mm L1 28mm temperatura ambiente máx. 125°C distancia de sujeción 22mm tipo V-166-1CR5 fuerza de accionamiento: 86g		

accionados por rodillo

rollo 0°

			
1			
código	347080	referencia	33400026 CM33400026
descripción	microinterruptor con rueda de presión 10A 1CO empalme atornillado temperatura ambiente máx. 85°C rosca M12x1		
Para modelos:	RB400		

interruptores de flotador

			
1			
código	345365	referencia	814091790 CM81409179
descripción	interruptor de flotador 250V 16A 1CO conector Faston 6,3mm L 150mm temperatura ambiente máx. 125°C distancia de sujeción 23mm tipo EF83161.5 fuerza de accionamiento: 5g negro		
Para modelos:	GP20, GP20W, GP30, GP30W, GP40, GP40W, GP50, GP50W, GP75, GP75W, GP90, GP90W		

			
1			
código	347088	referencia	CM81449091
descripción	interruptor de flotador con varilla 250V 16A 1CO conector Faston 6,3mm L 130mm temperatura ambiente máx. 125°C distancia de sujeción 23mm tipo EF83161.5 fuerza de accionamiento: 5g negro		



flotadores



1

código	695036	referencia	4114149S&P 66058500 783127.00
descripción	flotador para máquina de hielo ø 75mm L 115mm H 40mm plástico		
Para modelos:	AF10, AF100, AF20, AF200, AF30, AF80, MAR1, MAR10, MAR125, MAR2, MAR5, MF20, MF22, MF26, MF30, MF36, MF41, MF46, MF51, MF56, MF56ASR, MF61, MF62, MF66, MF66ASR		

accesorios



1

código	695998	referencia	0200338301 0200338321
descripción	barra for float switch ø 15mm L 180mm tamaño orificio 3,5x30mm plástico		



1

código	695649	referencia	0200338302
descripción	barra for float switch ø 15mm L 180mm tamaño orificio 3,5x51mm plástico		

interruptores centrífugos



1

código	346986	referencia	0A02749401
descripción	interruptor centrífugo		

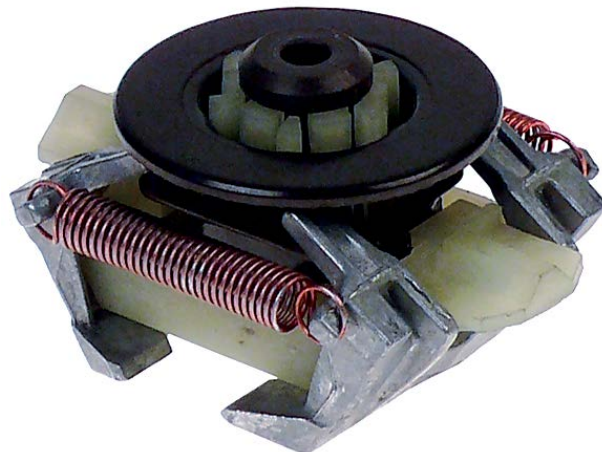

1

código	347062	referencia	65039100
descripción	interruptor centrífugo		

interruptores de contacto



1

código	402039	referencia	78508600 78508602R
descripción	barrera luminosa		
Para modelos:	MF30, MF61		



1

código	402043	referencia	650674.01 65067402 78508602
descripción	barrera luminosa L 180mm An 35mm H 46mm		
Para modelos:	AF10, AF100, AF20, AF200, AF30, AF80, MF20, MF22, MF26, MF30, MF36, MF41, MF46, MF51, MF56, MF56ASR, MF61, MF62, MF66, MF66ASR		



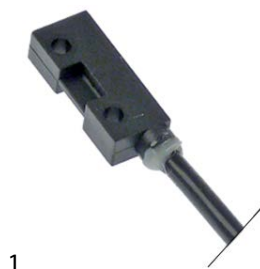

interruptores magnéticos

36x13mm

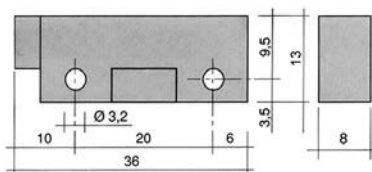

1



código	345118 ¹	referencia	CM33210019
descripción	interruptor magnético L 36mm An 13mm 1NO 250V 1A P máx. 50W empalme cable longitud del cable 980mm		
Para modelos:	MV12, MV18-21, MV25-32		
accesorios para	345118		
	código	345399	referencia 19355007 CM19355004
imán ø 3.3mm L 40mm H 8mm An 13mm dist. del agujero 30mm M3			

¹con conexión codificado

accesorios

imanes



1

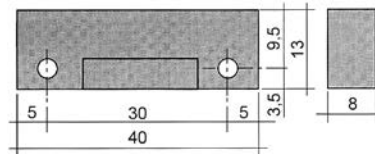

código	345399	referencia	19355007 CM19355004
descripción	imán ø 3.3mm L 40mm H 8mm An 13mm dist. del agujero 30mm M3		
Para modelos:	MV12, MV18-21, MV25-32, MV50		



1

código	402009	referencia	1129015S&P 650674.07 65067400 783167.01
descripción	barrera luminosa L 310mm An 35mm H 47mm		
Para modelos:	AC045, AC055, AC085, AC105, AC125, AC125B, AC125C, AC175, AC225, AC226, ACM125, ACM175, ACM85, Barline-B40, Barline-B65, Barline-B90, Barline-BUL40, Barline-BUL65, Barline-BUL90, EC045, MC1210, MC15, MC16, MC45, MC46, MC8		



1

código	402018	referencia	11054021
descripción	barrera luminosa para espesor hielo juego		
Para modelos:	CME1056, CME1056R, CME1356, CME1356R, CME1386, CME1656, CME1656R, CME1686, CME1856W, CME2086, CME256, CME306, CME456, CME456R, CME506, CME506R, CME656, CME656R, CME806, CME806R		



1

código	402142	referencia	0200362621
descripción	barrera luminosa sensor contenedor		



otros



1

código	347066	referencia	03289101 0A03289101
descripción	interruptor de seguridad 250V ø 58mm H 40mm 15A		

lámparas

lámparas de señalización

lámparas de señalización completas

ø10mm

con casquillo roscado



1

código	359889	referencia	63009108
descripción	lámpara de señalización ø 10mm 230V rojo empalme cable		
Para modelos:	MF102		

ø13mm

con casquillo enchufable



1

código	359141	referencia	63009111 63009114
descripción	lámpara de señalización ø 13mm rojo 230V empalme conector Faston 6,3mm resis.a la temp. 120°C UE 1 pzs		
Para modelos:	AF10, AF20, AF30, MAR10, MAR125, MAR20, MAR30, MAR5, MF82		



1

código	359142	referencia	63009102
descripción	lámpara de señalización ø 13mm verde 230V empalme conector Faston 6,3mm resis.a la temp. 120°C UE 1 pzs		

temporizadores

temporizadores de programa



1

código	500762	referencia	1200198002 1200231722 12-1980-02
descripción	motorreductor 50/60Hz 3W 230V H 32mm L 64mm An 49mm tipo CL082994 tensión AC 25rev/min árbol ø 5/6mm		
Para modelos:	CM1000R, CM1400, CM1400R, CM450E, CM650A, CM650C, CM650D, CM650RA, CM650RC, CM650RD, CM855, CM855R		



1

código	500743	referencia	1200231726
descripción	motorreductor 50Hz 3W 230V H 32mm L 64mm An 49mm tensión AC 15rev/min árbol ø 5/6mm		



1

código	500749	referencia	0A2592301 12001979 21
descripción	motorreductor SINGER 60Hz 3W 115V H 32mm L 64mm An 49mm tipo 3666131 tensión AC 15rev/min árbol ø 4,5x6mm		



1

código	360377	referencia	62038705
descripción	temporizador		
Para modelos:	AC225, MC1210, MC15, MC45		



1

código	360079	referencia	1112079S&P 62024413
descripción	temporizador FIBER P23 motores 1 cámaras 1 tiempo de funcionamiento 12min aliment. 230V eje L 30mm N° fabricante P235JR1J505 tipo de motor M51BJ0R6400		
repuestos para	360079		
	código	360673	referencia —
	kit de motor piñón ø 6.8mm dientes 15 aliment. 230V tensión AC 50/60Hz sentido de rotación en sentido horario ø motor 48mm H 18.5mm tipo motor UDS40NE1RNZ165 longitud del cable 150mm con soporte		



1

código	360163	referencia	620244.02
descripción	temporizador FIBER P23 motores 1 cámaras 1 tiempo de funcionamiento 15min aliment. 230V eje L 30mm N° fabricante P235JR1J706 tipo de motor M51BJ0R6400		
repuestos para	360163		
	código	360673	referencia —
	kit de motor piñón ø 6.8mm dientes 15 aliment. 230V tensión AC 50/60Hz sentido de rotación en sentido horario ø motor 48mm H 18.5mm tipo motor UDS40NE1RNZ165 longitud del cable 150mm con soporte		



1

código	360162	referencia	62024409
descripción	temporizador FIBER P23 motores 1 cámaras 2 tiempo de funcionamiento 12min aliment. 230V N° fabricante P235JR2J501 tipo de motor M51BJ0R6400		
Para modelos:	ACM85		
repuestos para	360162		
	código	360673	referencia —
	kit de motor piñón ø 6.8mm dientes 15 aliment. 230V tensión AC 50/60Hz sentido de rotación en sentido horario ø motor 48mm H 18.5mm tipo motor UDS40NE1RNZ165 longitud del cable 150mm con soporte		





1

código	360052	referencia	620244.04
descripción	temporizador FIBER P23 motores 1 cámaras 2 tiempo de funcionamiento 15min aliment. 230V N° fabricante P235JR1J707 tipo de motor M51BJ0R6400		
repuestos para	360052		
	código	360673	referencia —
	kit de motor piñón ø 6.8mm dientes 15 aliment. 230V tensión AC 50/60Hz sentido de rotación en sentido horario ø motor 48mm H 18.5mm tipo motor UDS40NE1RNZ165 longitud del cable 150mm con soporte		



1

código	360051	referencia	62043100 Z1EL003
descripción	temporizador FIBER P36 motores 1 cámaras 2 tiempo de funcionamiento 15min aliment. 230V eje ømm eje Lmm N° fabricante P365JR2J717 tipo de motor M51BJ0R6400		
repuestos para	360051		
	código	360673	referencia —
	kit de motor piñón ø 6.8mm dientes 15 aliment. 230V tensión AC 50/60Hz sentido de rotación en sentido horario ø motor 48mm H 18.5mm tipo motor UDS40NE1RNZ165 longitud del cable 150mm con soporte		



1

código	360371	referencia	62044102
descripción	temporizador FIBER P36 motores 1 cámaras 2 tiempo de funcionamiento 8min aliment. 230V eje ømm eje Lmm N° fabricante P365JR2J236 tipo de motor M51BJ0R6400		
Para modelos:	Barline-65, Barline-90		
repuestos para	360371		
	código	360673	referencia —
	kit de motor piñón ø 6.8mm dientes 15 aliment. 230V tensión AC 50/60Hz sentido de rotación en sentido horario ø motor 48mm H 18.5mm tipo motor UDS40NE1RNZ165 longitud del cable 150mm con soporte		



1

código	380888	referencia	CM33730712
descripción	contactor de potencia AC1 20A 230VAC (AC3/400V) 12A/5,7kW contactos principales 3NO contactos auxiliares 1NC empalme empalme atornillado tipo 11BG1201A230		
Para modelos:	MV300, MV450, MV456, MV600, MV800		



1

código	380704	referencia	63011900
descripción	contactor de potencia AC1 20A 230VAC (AC3/400V) 9A/4kW contactos principales 3NO contactos auxiliares 1NC empalme empalme atornillado tipo 11BG0901A230		
Para modelos:	AC225, AC226, MF41, MF46, MF51, MV12, MV18, MV18-21, MV25, MV25-32		

contactores

LOVATO

contactores de potencia



1

código	380946	referencia	63012405
descripción	contactor AC1 25A 230VAC (AC3/400V) 12A/5,7kW contactos principales 3NO contactos auxiliares 1NC empalme empalme atornillado tipo BF12012205060		
Para modelos:	MAR10, MAR125, MAR5, MC1210, MC15, MC16, MC45, MC46, MF41, MF51, MF61, MF66, MF66ASR, MV1000, MV50		



1

código	380574	referencia	63012400
descripción	contactor de potencia AC1 25A 230VAC (AC3/400V) 12A/5,7kW contactos principales 3NO contactos auxiliares 1NO empalme empalme atornillado tipo B12		
Para modelos:	MF102		



1

código	380087	referencia	63011902
descripción	contactor de potencia AC1 16A 230VAC (AC3/400V) 5A/2,2kW contactos principales 3NO contactos auxiliares 1NO empalme empalme atornillado tipo 11BG0610A230		
Para modelos:	AC125, AC125B, AC125C, AC126, AC175, AC176, ACM125, ACM175, Barline-65, Barline-90, Barline-B65, Barline-B90, Barline-BUL65, Barline-BUL90		

otros

contactores de potencia



1

código	380578	referencia	1200204802 1200246902
descripción	contactor de potencia aliment. 208/240V AC1 30A contactos principales 2NO empalme conector Faston 6,3mm		



relés

relés de potencia

con lengüeta de sujeción



1

código	380312	referencia	1109039S&P 62023702 CM19620107
descripción	relé de potencia FINDER 230VAC 10A 3CO empalme conector Faston 4,8mm lengüeta de sujeción medidas 52x32,2x36,5mm N° fabricante 60.63.8.230.0000		



1

código	380185	referencia	CM19620103
descripción	relé de potencia Italiana Relè 230VAC 30A 1NO empalme F6,3 lengüeta de sujeción medidas 36,5x32,2x51,8mm N° fabricante A10-230AC-FA		

con contactos enchufables

conectores redondos, 11 contactos



1

código	380132	referencia	1109066S&P 62007603
descripción	relé de potencia Italiana Relè 230VAC 10A 3CO empalme empalme enchufable 11 polos N° fabricante C43-230AC ZVE11 250V 11 polos		
accesorios para	380132		
	código	380136	referencia —
	zócalo de relé 11 polos empalme empalme enchufable 11 polos medidas 65x28x40mm 250V tensión AC 10A Italiana Relè N° fabricante ZVE11		

relés de temporización

relés de temporización



1

código	350129	referencia	06052600 62037100
descripción	relé de temporización FIBER R11B52307F0 margen de tiempo 6s-30min 230VAC 2x6A 1NO/1CO empalme conector Faston 6,3mm		
Para modelos:	MAR1, MAR10, MAR2, MAR20, MAR3, MAR30, MAR5		



1

código	380584	referencia	62038703
descripción	relé de temporización SYRELEC BAR.F margen de tiempo 0-10min 220-240VAC 5A 1CO empalme atornillado		
Para modelos:	MF82		

otros



1

código	380580	referencia	CM33580057
descripción	relé empalme con cable para bomba		
Para modelos:	MV50		



transformadores

transformadores abiertos

con clavija



1

código	401827	referencia	1200261721
descripción	transformador primaria 230V secundaria 24V 75VA 50/60Hz		

sensores

sensores específicos del fabricante

sensores



1

código	403855	referencia	620519 04
descripción	sensor NTC 10kOhm cable PVC sonda -40 a +110°C cable -10 a 100°C empalme conector rosca bulbo ø5x45mm longitud de cable 1.7m		



1

código	379628	referencia	0200341021 02-3410-21
descripción	sensor de temperatura 2x NTC 10K cable PVC sonda -40 a +110°C cable -10 a 100°C empalme conector codificado rosca bulbo ø6,5x-45mm longitud de cable 0,4/0,55m		
Para modelos:	CME1056, CME1056R, CME256, CME506, CME506R, CME656, CME656R, CME806, CME806R		



1

código	379564	referencia	CM25702401
descripción	sensor de temperatura 2x NTC 10K cable PVC sonda -40 a +110°C cable -10 a 100°C empalme conector codificado rosca bulbo ø6,5x-45mm longitud de cable 0,7/1,3m		



1

código	402138	referencia	1100054501 1100054521 11054501 11054521 1106291S&P
descripción	sensor de temperatura 2x NTC 10K cable PVC sonda -40 a +110°C cable -10 a 100°C empalme conector codificado rosca bulbo ø6,5x-45mm longitud de cable 0.6m		
Para modelos:	CME306, CME456, CME456R, CME686, CME810		

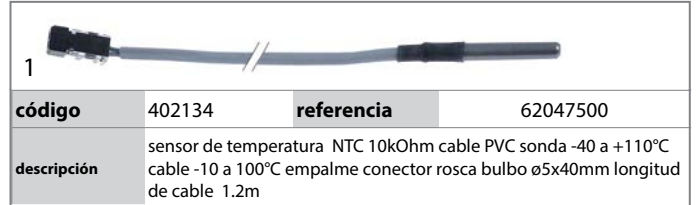

1

código	402134	referencia	62047500
descripción	sensor de temperatura NTC 10kOhm cable PVC sonda -40 a +110°C cable -10 a 100°C empalme conector rosca bulbo ø5x40mm longitud de cable 1.2m		



1

código	402133	referencia	62047501
descripción	sensor de temperatura NTC 10kOhm cable PVC sonda -40 a +110°C cable -10 a 100°C empalme conector rosca bulbo ø6x60mm longitud de cable 1.5m		

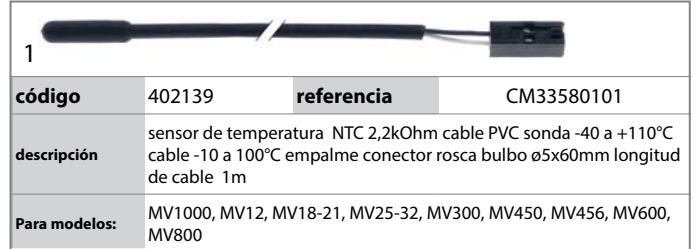

1

código	402139	referencia	CM33580101
descripción	sensor de temperatura NTC 2,2kOhm cable PVC sonda -40 a +110°C cable -10 a 100°C empalme conector rosca bulbo ø5x60mm longitud de cable 1m		
Para modelos:	MV1000, MV12, MV18-21, MV25-32, MV300, MV450, MV456, MV600, MV800		

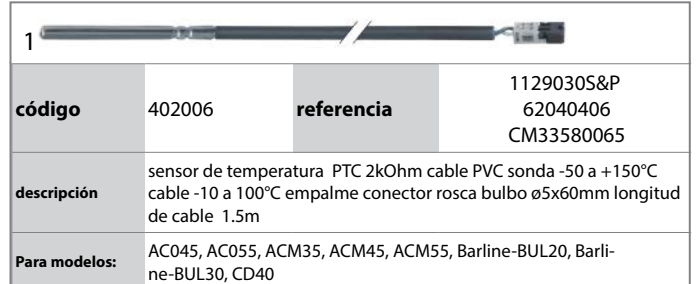



1

código	402006	referencia	1129030S&P 62040406 CM33580065
descripción	sensor de temperatura PTC 2kOhm cable PVC sonda -50 a +150°C cable -10 a 100°C empalme conector rosca bulbo ø5x60mm longitud de cable 1.5m		
Para modelos:	AC045, AC055, ACM35, ACM45, ACM55, Barline-BUL20, Barline-BUL30, CD40		



1 			
código	378231	referencia	33580066/1 CM33580066
descripción	sensor de temperatura PTC 2kOhm cable PVC sonda -50 a +150°C cable -10 a 100°C empalme conector rosca bulbo ø5x60mm longitud de cable 1.9m		
Para modelos:	CD40		

1 			
código	402008	referencia	11290435&P 62040402
descripción	sensor de temperatura PTC 2kOhm cable PVC sonda -50 a +150°C cable -10 a 100°C empalme conector rosca bulbo ø6x50mm longitud de cable 1.2m		
Para modelos:	AC085, AC125, AC125B, AC125C, AC175, AC225, ACM125, ACM175, ACM85, Barline-B40, Barline-B65, Barline-B90, Barline-BUL40, Barline-BUL65, Barline-BUL90, MC1210, MC15, MC45		

1 			
código	402191	referencia	11291345&P 62040401 62040411
descripción	sensor de temperatura PTC 2kOhm cable TPE sonda -50 a +150°C cable -40 a +110°C empalme conector rosca bulbo ø5x20mm longitud de cable 1.8m		
Para modelos:	AC045, AC046, AC055, AC056, AC085, AC086, AC105, AC106, AC125, AC125B, AC125C, AC126, AC175, AC176, AC225, AC226, ACM125, ACM175, ACM85, AF10, AF100, AF20, AF200, AF30, AF80, Barline-B40, Barline-B65, Barline-B90, Barline-BUL40, Barline-BUL65, Barline-BUL90, EC045, MC1210, MC15, MC16, MC45, MC46, MC8, MF20, MF22, MF26, MF30, MF36, MF41, MF46, MF51, MF56, MF56ASR, MF61, MF62...(Otros modelos se puede ver en la tienda web)		

1 			
código	402005	referencia	11290295&P 620404.00 62040410
descripción	sensor de temperatura PTC 2kOhm cable TPE sonda -50 a +150°C cable -40 a +110°C empalme conector rosca bulbo ø6x50mm longitud de cable 1.6m		
Para modelos:	AC045, AC055, AC085, AC105, AC106, AC125, AC125B, AC125C, AC126, AC175, AC176, AC225, AC226, ACM125, ACM175, ACM35, ACM45, ACM55, ACM85, AF10, AF100, AF20, AF200, AF30, AF80, Barline-B40, Barline-B65, Barline-B90, Barline-BUL20, Barline-BUL30, Barline-BUL40, Barline-BUL65, Barline-BUL90, EC045, MC1210, MC15, MC16, MC45, MC46, MC8, MF20, MF22, MF26, MF30, MF36, MF41, MF46, MF51, MF56, MF56ASR...(Otros modelos se puede ver en la tienda web)		

sensores Hall

1 			
código	402044	referencia	62040403
descripción	Sensor Hall L 29mm An 26mm H 26mm distancia de sujeción 10mm longitud del cable 1250mm		
Para modelos:	AF10, AF100, AF20, AF200, AF30, AF80, MAR125, MF20, MF22, MF26, MF30, MF36, MF41, MF46, MF51, MF56, MF56ASR, MF61, MF62, MF66, MF66ASR		

accesorios

otros

1 			
código	402040	referencia	1129159S&P 62040404 62040413
descripción	cable para electrodos de nivel longitud del cable 1800mm		
Para modelos:	AF10, AF100, AF20, AF200, AF30, AF80, EC045, MF20, MF22, MF26, MF30, MF36, MF41, MF46, MF51, MF56, MF56ASR, MF61, MF62, MF66, MF66ASR		

electrónicas

cajas de platinas

1 			
código	694205	referencia	66054800
descripción	caja placa electrónica L 180mm An 110mm H 40mm		
Para modelos:	AC125B, AC125C, AC175, AF10, AF20, AF30		
accesorios para	694205		
	código	694206	referencia
			19190397/0 66054700 660547.01 660547.02 CM19190403
tapa placa electrónica L 180mm An 110mm H 9mm			

1 			
código	695663	referencia	29070021 29070025&P 4114460 66054600 CM29070021
descripción	caja placa electrónica L 230mm An 142mm H 57mm		
Para modelos:	AC105, AC125B, AC125C, AC175, AC225, ACM125, ACM175, ACM35, ACM45, ACM55, ACM85, AF10, AF100, AF20, AF200, AF30, AF80, Barline-B40, Barline-B65, Barline-B90, Barline-BUL20, Barline-BUL30, Barline-BUL40, Barline-BUL65, Barline-BUL90, CD40, MC1210, MC15, MC45, MF30, MF61		

1



código	694206	referencia	19190397/0 660547.01 660547.02 66054700 CM19190403
descripción	tapa placa electrónica L 180mm An 110mm H 9mm		
Para modelos:	AC105, AC125B, AC125C, AC175, AC225, ACM125, ACM175, ACM35, ACM55, ACM85, AF10, AF100, AF20, AF200, AF30, AF80, Barline-B40, Barline-B65, Barline-B90, Barline-BUL20, Barline-BUL30, Barline-BUL40, Barline-BUL65, Barline-BUL90, CD40, MC1210, MC15, MC45, MF30, MF41, MF51, MF61		
accesorios para	694206		
	código	694205	referencia 66054800
	caja placa electrónica L 180mm An 110mm H 40mm		

1



código	694796	referencia	CM29015057
descripción	tapa placa electrónica L 205mm An 125mm H 14mm plástico		

placas electrónicas

1



código	402124	referencia	62048303
descripción	placa de display máquina de hielo en cubitos		

1



código	402145	referencia	33580084 CM33580084
descripción	placa de display para máquina de hielo longitud del cable 1500mm con LED		
Para modelos:	CD40		

1

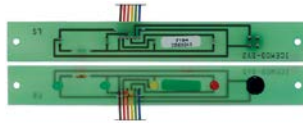

código	401801	referencia	CM33580024
descripción	placa de teclado máquina de hielo en cubitos N200/N300/N500		
Para modelos:	MV12, MV18, MV18-21, MV25, MV25-32, MV50		

1



código	401824	referencia	33580123 CM33580123
descripción	placa electrónica		

1



código	401825	referencia	33580017 CM33580017
descripción	placa electrónica		

1



código	401826	referencia	1200237621
descripción	placa electrónica		



1

código	402033	referencia	62046218
descripción	placa electrónica		



1

código	402034	referencia	1114068S&P 62045602
descripción	placa electrónica		



1

código	403499	referencia	33580173 CM33580173
descripción	placa electrónica aliment. 230V L 90mm An 60mm para máquina de hielo		
Para modelos:	MV1000, MV800		



1

código	403021	referencia	1114285 CM33580064
descripción	placa electrónica apto para Scotsman tipo WSCM0252		
Para modelos:	CD40		



1

código	402137	referencia	02003707.21 11000539.21 1100053951 11-0539-51 1129170
descripción	placa electrónica for float switch		
Para modelos:	CME1056, CME1056R, CME1356, CME1356R, CME1386, CME1656, CME1656R, CME1686, CME1856W, CME2086, CME256, CME306, CME456, CME456R, CME506, CME506R, CME656, CME656R, CME686, CME806, CME806R, CME810		



1

código	402136	referencia	81453901 CM81453901
descripción	placa electrónica Kit 230V		



1

código	402035	referencia	62040301 62040312 62040320 62045600
descripción	placa electrónica L 190mm An 110mm aliment. 230V		
Para modelos:	AC105, AC125B, AC125C, AC175, AC225, ACM125, ACM85, MC1210, MC15, MC45		



1

código	403881	referencia	620462 20 62046211
descripción	placa electrónica L 200mm An 135mm		





1

código	402003	referencia	1114010S&P 620403.05 620403.17 62040316
descripción	placa electrónica máquina de hielo en cubitos AC045/055		
Para modelos:	AC045, AC055, ACM35, ACM45, ACM55, Barline-BUL20, Barline-BUL30		





			
1			
código	400055	referencia	62047000
descripción	placa electrónica máquina de hielo en cubitos ECO 45 230V		
Para modelos:	EC045		

			
1			
código	403478	referencia	620507.01
descripción	placa electrónica máquina de hielo en cubitos L 90mm An 72mm apto para Simag H 30mm		

			
1			
código	401799	referencia	CM33580150
descripción	placa electrónica máquina de hielo en cubitos N201/N301//N501 aliment. 230V		
Para modelos:	MV1000, MV300, MV450, MV600, MV800		
accesorios para	401799		
	código	referencia	CM81455102
	 cable de enlace L 1300mm 2 polos sensor de nivel apto para máquina de hielo en cubitos empalme conector tipo de conector conector codificado		

			
1			
código	401828	referencia	00102831
descripción	placa electrónica para máquina de hielo con carcasa		

			
1			
código	401833	referencia	1100053122
descripción	placa electrónica para máquina de hielo con soporte 24V		

			
1			
código	401823	referencia	CM33580056
descripción	placa electrónica para máquina de hielo en cubitos		
Para modelos:	MV50		

			
1			
código	403486	referencia	62050700
descripción	temporizador electrónico L 73mm An 73mm apto para Simag H 30mm temporizador		

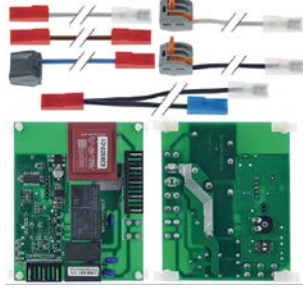
			
1			
código	403687	referencia	06076900 62044100
descripción	temporizador electrónico para máquina de hielo Simag medida de montaje 90x70mm 230		
Para modelos:	Barline-50		

unidades centrales

			
1			
código	402004	referencia	06071110 1114466 62040303 62040309 62045602 62046202
descripción	caja electrónica		
Para modelos:	AF10, AF100, AF20, AF200, AF30, AF80, MF20, MF22, MF26, MF30, MF36, MF41, MF46, MF51, MF56, MF56ASR		
accesorios para	402004		
	código	referencia	1129029S&P 620404.00 62040410
	sensor de temperatura PTC 2kOhm cable TPE sonda -50 a +150°C cable -40 a +110°C empalme conector rosca bulbo ø6x50mm longitud de cable 1.6m		

Continúa en la página siguiente



accesorios para	402004		
	código	402044	referencia 62040403
	Sensor Hall L 29mm An 26mm H 26mm distancia de sujeción 10mm longitud del cable 1250mm		
	código	402191	referencia 11291345&P 62040401 62040411
	sensor de temperatura PTC 2kOhm cable TPE sonda -50 a +150°C cable -40 a +110°C empalme conector rosca bulbo ø5x20mm longitud de cable 1.8m		

	1		
código	403028	referencia	62040318
descripción	caja electrónica		

	1		
código	402135	referencia	62047300
descripción	caja electrónica 230V		

	1		
código	402042	referencia	001028.09 028640.98 06071100 62046200
descripción	caja electrónica apto para SFT 012		
Para modelos:	AC045, AC055, AC085, AC105, AC106, AC125, AC126, AC175, AC176, AC225, AC226, EC045, MC1210, MC15, MC16, MC45, MC46		

	1		
código	401829	referencia	62040409
descripción	caja electrónica con carcasa para máquina de hielo		
Para modelos:	MF61		

	1		
código	401832	referencia	060711.30 78510400R 78510402R
descripción	caja electrónica con carcasa para máquina de hielo en cubitos 230V		
Para modelos:	AC046, AC056, AC086, AC106, AC126, AC176, AC226		

	1		
código	403836	referencia	CF62046213 CF62046215
descripción	caja electrónica máquina de hielo en cubitos para ICEMATIC/SCOTSMAN/SIMAG		

	1		
código	403837	referencia	81400264/0 CM81400264/0
descripción	caja electrónica máquina de hielo en cubitos para ICEMATIC/SCOTSMAN/SIMAG		

	1		
código	401841	referencia	0A037703.21 12002543.21 12002543.24 12002838.21 12002838.22 12002838.24 1200283823 12283823 17002389.01
descripción	caja electrónica para máquina de hielo en cubitos 24V 50-60Hz		
Para modelos:	CME1056, CME1056R, CME1356, CME1356R, CME1386, CME1656, CME1656R, CME1686, CME1856W, CME2086, CME256, CME306, CME456, CME456R, CME506, CME506R, CME656, CME656R, CME686, CME806, CME806R, CME810		



1

código	401842	referencia	33580122 CM33580122
descripción	caja electrónica para máquina de hielo en cubitos 24V 50-60Hz		

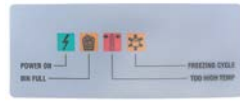

1

código	694118	referencia	4114695 65062408
descripción	membrana de teclado para máquina de hielo en cubitos L 134mm An 52mm		
Para modelos:	AC125, AC175, ACM125, ACM175		

teclados

membranas de teclado



1

código	695867	referencia	65075303
descripción	membrana de teclado para dispensador de hielo L 145mm An 90mm		



1

código	694113	referencia	65075305
descripción	membrana de teclado para dispensador de hielo L 150mm An 100mm		



1

código	694117	referencia	29020013
descripción	membrana de teclado para dispensador de hielo L 80mm An 70mm		



1

código	694116	referencia	1700228806
descripción	membrana de teclado para dispensador de hielo L 95mm An 76mm		



1

código	695843	referencia	19262733 CM19262733
descripción	membrana de teclado para máquina de hielo L 265mm An 76mm		
Para modelos:	MV1000, MV450, MV456, MV600, MV800		



1

código	695842	referencia	19262763 CM19262763
descripción	membrana de teclado para máquina de hielo pos. de montaje interior L 25mm An 140mm		
Para modelos:	MV300, MV450, MV600		

válvulas magnéticas

válvulas magnéticas agua

ELBI

recto



1

código	370529	referencia	65010503	
descripción	válvula magnética simple recto 120VAC entrada 3/4" salida 11,5mm DN10 T máx 60°C ELBI			
Para modelos:	AC125B, AC125C, AC175, AC225, ACM85			
repuestos para	370529			
	código	370467	referencia	—
	filtro de válvula magnética apto para ELBI			





1

código	373017	referencia	65010500
descripción	válvula magnética simple recto 230VAC entrada 3/4" salida 11,5mm DN10 ELBI		
Para modelos:	AC125B, AC125C, AC175, AC225, ACM125, ACM35, ACM45, ACM55, ACM85, MC15, MC45		
repuestos para	373017		
	código	370467	referencia —
	filtro de válvula magnética apto para ELBI		



1

código	373015	referencia	62021300
descripción	válvula magnética simple acodado 230VAC entrada 3/4" salida 11,5mm DN10 ELBI		
Para modelos:	MC1210		
repuestos para	373015		
	código	370467	referencia —
	filtro de válvula magnética apto para ELBI		



1

código	373000	referencia	19865537 CM19865537
descripción	válvula magnética simple recto 24V entrada 3/4" salida 11,5mm DN10 T máx 90°C ELBI plástico		
repuestos para	373000		
	código	370467	referencia —
	filtro de válvula magnética apto para ELBI		



1

código	373001	referencia	65010554
descripción	válvula magnética simple recto 230VAC entrada 3/4" salida 11,5mm reducción entrada Al/min reducción salida 2l/min 50/60Hz DN10 T máx 90°C ciclo de trabajo 100% ELBI plástico		
Para modelos:	AC225, AC226, MC15, MC16, MC8, MV1000, MV300, MV450, MV456, MV600, MV800		

acodado



1

código	370530	referencia	1124346 62021301
descripción	válvula magnética simple acodado 120VAC entrada 3/4" salida 11,5mm reducción entrada A 16l/min DN10 T máx 60°C ELBI plástico		
repuestos para	370530		
	código	370467	referencia —
	filtro de válvula magnética apto para ELBI		



1

código	370431	referencia	65010552 CM19865518 Z1D002
descripción	válvula magnética simple recto 230VAC entrada 3/4" salida 11,5mm reducción entrada Al/min reducción salida 2l/min DN10 T máx 90°C ELBI plástico		
Para modelos:	AC105, AC125, AC126, AC175, AC176, ACM125, ACM175, Barline-65, Barline-90, Barline-B65, Barline-B90, Barline-BUL65, Barline-BUL90, CD40		



1

código	370414	referencia	CM19865502 Z1D003
descripción	válvula magnética simple recto 230VAC entrada 3/4" salida 11,5mm reducción salida 2l/min 50/60Hz T máx 90°C ELBI plástico reducción salida blanco		



1

código	370461	referencia	CM19865509
descripción	válvula magnética doble recto 230VAC entrada 3/4" salida 11,5mm reducción entrada Al/min reducción salida -/4,7l/min DN10 T máx 90°C ELBI plástico reducción salida B 4.7l/min reducción salida B gris salida A sin membrana (siempre abierto)		



1

código	370433	referencia	65010551
descripción	válvula magnética doble recto 230VAC entrada 3/4" salida 11,5mm reducción entrada Al/min reducción salida 2/2,5l/min DN10 T máx 90°C ELBI plástico reducción salida A 2l/min reducción salida B 2.5l/min reducción salida A blanco reducción salida B naranja		
Para modelos:	AC045, AC055, AC085, AC105, ACM45, Barline-20, Barline-30, Barline-40, Barline-50, Barline-B40, Barline-BUL20, Barline-BUL30, Barline-BUL40, EC045, ICE-ONE, ICE-THREE, ICE-TWO, SD18		



1

código	370526	referencia	65010553
descripción	válvula magnética doble recto 230VAC entrada 3/4" salida 11,5mm reducción entrada Al/min reducción salida 2/2l/min DN10 T máx 60°C ELBI reducción salida A 2 blancol/min reducción salida B 2 blancol/min		
Para modelos:	MC1210, MC45, MC46		



1

código	370499	referencia	65010562
descripción	válvula magnética doble, con reducción recto 230VAC entrada 3/4" salida 11,5mm T máx 60°C reducción salida A 2.5 naranjal/min reducción salida B 2 blancol/min		

ROBERTSHAW/INVENSYS

temperatura líquido: 90°C 90°C 60°C
 temperatura ambiente: 60°C 25°C 60°C
 ciclo de trabajo: 40% 100% 100%

diversos



1

código	371105	referencia	1200164604
descripción	válvula magnética acodado 240VAC entrada 3/8" salida 3/8" EATON (INVENSYS) tipo K-63314-12		



1

código	371104	referencia	1200143403
descripción	válvula magnética acodado 240VAC entrada 3/8" salida 3/8" SINGER		



1

código	371259	referencia	198655,98 62040601 CM19865532
descripción	válvula magnética simple acodado 230VAC entrada 11.5 salida 11,5mm DN7 plástico		
Para modelos:	AC225, ACM125, ACM175, ACM45, CD40, MC45		



1

código	370494	referencia	1200231302
descripción	válvula magnética simple acodado 240VAC salida 14,5mm entrada 1/4"mm		



RPE

salida especial

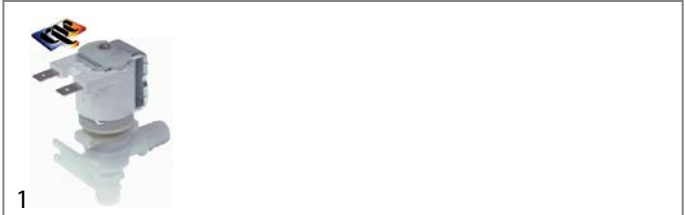

código	370453	referencia	060564.00 62046000 62046001
descripción	válvula magnética simple acodado 230VAC entrada 11.5mm salida 11,5mm RPE		
Para modelos:	AC045, AC055, AC085, AC105, AC125, AC126, AC175, AC176, AC225, AC226, ACM45, CD40, EC045, MC1210, MC15, MC16, MC45, MC46, MC8, MV300		

TP

válvulas magnéticas con reducciones



código	370416	referencia	CM19865530
descripción	válvula magnética doble recto 230VAC entrada 3/4" reducción entrada A1/min reducción salida 1,2/1,2l/min DN10 T máx 90°C TP plástico salida 11.5mm reducción salida A 1.2l/min reducción salida B 1.2l/min reducción salida A marrón oscuro reducción salida B marrón oscuro		

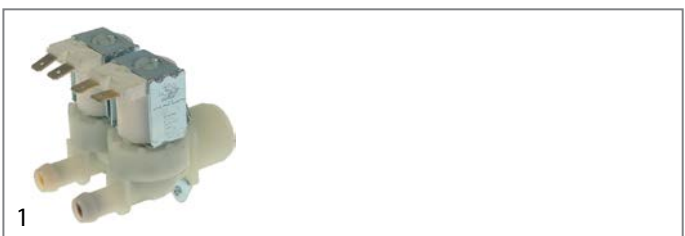

código	370422	referencia	65010570
descripción	válvula magnética doble recto 230VAC entrada 3/4" T máx 90°C TP plástico salida 11.5mm reducción salida A 2.5l/min reducción salida A amarillo reducción salida B marrón		
Para modelos:	AC086, AC106		

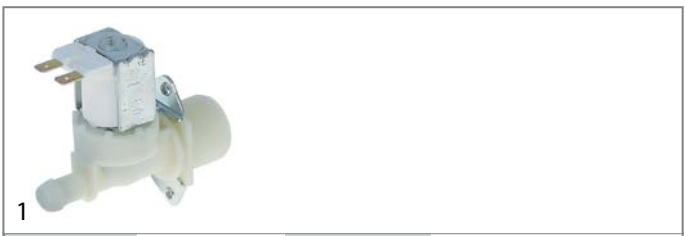

código	370527	referencia	65010564
descripción	válvula magnética simple recto 220-240VAC entrada 3/4" salida 11,5mm reducción salida 0.8l/min TP plástico reducción salida blanco 8VA		
Para modelos:	AC046		

diversos



código	370496	referencia	CM19865525
descripción	válvula magnética recto 220VAC salida 14mm plástico entrada 14mm		
Para modelos:	MV1000, MV12, MV18, MV18-21, MV25, MV25-32, MV450, MV50, MV600, MV800		



código	370491	referencia	1200244626
descripción	válvula magnética simple 240VAC entrada 3/4" salida 11,5mm		

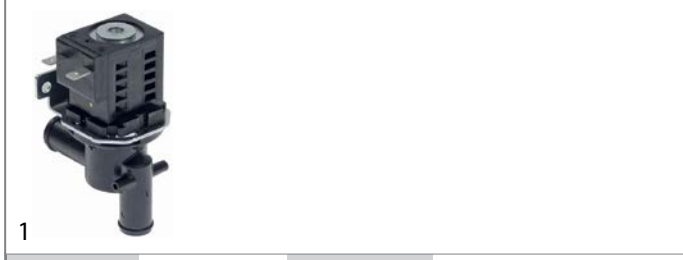

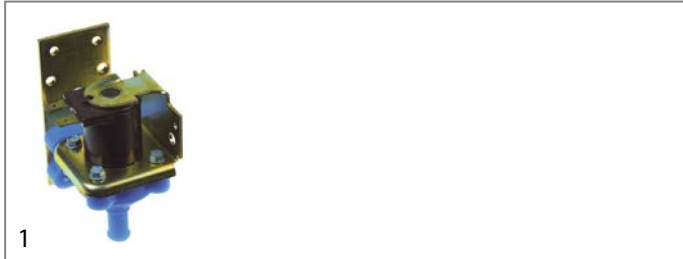

código	370830	referencia	1100056402 CM19865540
descripción	válvula magnética simple acodado 220-240VAC entrada 17,3mm salida 16mm DELTROL		
Para modelos:	MV456		





código	370493	referencia	1200254801 1200266601 12-2666-01
descripción	válvula magnética simple acodado 24V salida 11,5mm EATON (IN-VENSYS) plástico entrada 5/8" UNFmm		
Para modelos:	CME1056, CME1056R, CME1356, CME1356R, CME1386, CME1656, CME1656R, CME1686, CME1856W		



metal			
PARKER			
recambios y accesorios			
solenoides			
			
código	371098	referencia	62030615 62030628 62030628.01 62030648
descripción	bobina magnética 220-230VAC 50/60Hz soporte ø 14mm longitud del cable 1000mm 14W		
Para modelos:	AC045, AC046, AC055, AC056, AC085, AC086, AC105, AC106, AC125, AC125B, AC125C, AC126, AC175, AC176, AC225, AC226, ACM125, ACM175, ACM25, ACM35, ACM45, ACM55, ACM85, Barline-20, Barline-21, Barline-30, Barline-31, Barline-40, Barline-50, Barline-65, Barline-90, Barline-B40, Barline-B65, Barline-B90, Barline-BUL20, Barline-BUL30, Barline-BUL40, Barline-BUL65, Barline-BUL90, EC045, ICE-ONE, ICE-THREE, ICE-TWO, MC1210, MC15, MC16, MC45, MC46, MC8, MF62...(Otros modelos se puede ver en la tienda web)		

válvulas de desagüe			
			
código	371106	referencia	11000514.30 1100051401 1124246
descripción	electroválvula descarga 208/230V simple entrada 17.5mm salida 16mm EATON (INVENSYS) plástico		
Para modelos:	MV450, MV600		

			
código	370691	referencia	CM81454760
descripción	válvula magnética acodado 220-240V Kit entrada 17.5mm salida 16mm		

			
código	370540	referencia	1200143405
descripción	válvula magnética acodado 240V 50/60Hz salida 9/16" UNF plástico entrada 9/16" UNF		

válvulas magnéticas refrigeración			
ALCO			
válvulas			
con empalme de tubo			
			
código	370492	referencia	00247122 1200247122
descripción	válvula magnética 24V		

			
código	370535	referencia	1100049521
descripción	válvula magnética recto tipo 200RB5T4 230V p máx. 34.5bar empalme 12,7mm conexión para soldadura		

			
código	370534	referencia	1200213502
descripción	válvula magnética tipo 200RB3T3 230V tubo ø 9.5mm L 118mm gas caliente		

CASTEL			
válvulas			
			
código	370489	referencia	19865536 CM19865536
descripción	válvula magnética 24V 10 empalme 12mm conexión para soldadura CASTEL recto		







cuerpos de válvula

serie STANDARD

apto para refrigerantes R22, R134a, R404A, R407C, R410A, R507



1

código	370382	referencia	CM19863034
descripción	cuerpo de válvula magnética NC tipo 1028/M105 p máx. 45bar empalme 10mm conexión para soldadura DN 3mm -35 a +105°C L 125mm refrigeración recto CASTEL		
accesorios para	370382		
	código	371084	referencia —
	bobina magnética CASTEL 230VAC 8VA 50/60Hz empalme cable 1000mm tipo CM2		
	código	371090	referencia —
	enchufe tipo de conector DIN 43650A atornillado		
	código	371301	referencia —
	bobina magnética CASTEL 110VAC 8VA 50/60Hz soporte ø 11.5mm empalme DIN 43650A tipo HF2		
	código	371314	referencia —
	bobina magnética CASTEL 240VAC 8VA 50/60Hz soporte ø 11.5mm		
	código	371321	referencia —
	bobina magnética CASTEL 12/24VAC 50/60Hz soporte ø 11.5mm empalme DIN 43650A tipo HF2		

PARKER

válvulas



1

código	370415	referencia	CM19863032 CM19863033
descripción	válvula magnética recto 230V margen de presión 0-10bar DN2,5 empalme 4mm conexión para soldadura PARKER refrigeración		
Para modelos:	CD40		
repuestos para	370415		
	código	371033	referencia —
	bobina magnética PARKER 230VAC 9VA tipo de bobina YB09 mit Kabel soporte ø 14mm		



1

código	370490	referencia	19870611 CM19870611
descripción	válvula magnética tipo VE-145 230V 8 refrigeración		

cuerpos de válvula



1

código	370536	referencia	62030606
descripción	cuerpo de válvula magnética p máx. 35bar empalme 3/8" americano PARKER para máquina de hielo tubo ø 10mm gas caliente		
Para modelos:	MC1210		
accesorios para	370536		
	código	371098	referencia 62030615 62030628 62030628.01 62030648
	bobina magnética 220-230VAC 50/60Hz soporte ø 14mm longitud del cable 1000mm 14W		



1

código	370539	referencia	62030607
descripción	cuerpo de válvula magnética recto p máx. 35bar margen de presión 21bar empalme 10mm conexión para soldadura PARKER tubo ø 10mm L 150mm gas caliente		
Para modelos:	MC1210, MC45, MF62		

diversos

válvulas



1

código	370455	referencia	62030621
descripción	válvula magnética refrigeración		
Para modelos:	ACM55, ACM85		



imagen no disponible

1

código	370456	referencia	62030626
descripción	válvula magnética refrigeración		
Para modelos:	AC125B, AC125C, AC175, ACM125, ACM55, ACM85		



imagen no disponible

2

código	370457	referencia	62030631 62030632
descripción	válvula magnética refrigeración		
Para modelos:	AC225, MC15, MC45		



1

código	370454	referencia	62030646
descripción	cuerpo de válvula magnética DN 3mm empalme 6mm conexión para soldadura refrigeración acodado 90°		
Para modelos:	AC175, AC176, AC225, AC226, Barline-90, Barline-B90, Barline-BUL90, MC15, MC16, MC45, MC46, MC8		
accesorios para	370454		
	código	371033	referencia —
	bobina magnética PARKER 230VAC 9VA tipo de bobina YB09 mit Kabel soporte ø 14mm		

cuerpos de válvula



1

código	370429	referencia	62030627
descripción	cuerpo de válvula magnética acodado DN 2.5mm empalme 6mm conexión para soldadura refrigeración		
Para modelos:	AC055, AC056, AC085, AC086, AC105, AC106, AC125, AC126, ACM125, ACM175, Barline-30, Barline-31, Barline-40, Barline-50, Barline-65, Barline-B40, Barline-B65, Barline-BUL40, Barline-BUL65, ICE-THREE, ICE-TWO		
accesorios para	370429		
	código	371098	referencia 62030615 62030628 62030628.01 62030648
	bobina magnética 220-230VAC 50/60Hz soporte ø 14mm longitud del cable 1000mm 14W		



1

código	370430	referencia	62030613
descripción	cuerpo de válvula magnética empalme 6mm conexión para soldadura refrigeración acodado 90°		
Para modelos:	ACM35, ACM45		



1

código	370458	referencia	62030614
descripción	cuerpo de válvula magnética empalme 6mm conexión para soldadura refrigeración acodado 90°		
Para modelos:	ACM25, SD18		



1

código	370424	referencia	62030622
descripción	cuerpo de válvula magnética DN 1.9mm empalme 6mm conexión para soldadura refrigeración acodado 90°		
Para modelos:	AC045, AC046, ACM45, Barline-20, Barline-21, Barline-BUL20, EC045, ICE-ONE		

Válvulas magnéticas - accesorios

filtros



1

código	371101	referencia	65010400
descripción	filtro de válvula magnética ø 20mm H 17mm apto para ELBI		
Para modelos:	AF10, AF20, AF30, MAR1, MAR10, MAR2, MAR20, MAR3, MAR30, MAR5, MF102, MF82		



1 

código	371087	referencia	C11800503
descripción	bobina magnética longitud del cable 1100mm soporte ø 6.5mm		

1 

código	694217	referencia	73312300
descripción	caja para reductor L 15mm ø 11mm		
Para modelos:	MC1210, MC15, MC45		

1 

código	371108	referencia	73318500
descripción	cuerpo para reductor H 10mm ø 15.7mm		
Para modelos:	AC125B, AC125C, AC175, AC225, ACM125, ACM35, ACM45, ACM55, ACM85		

1 
imagen no disponible

código	371294	referencia	64002206
descripción	reducción velocidad de flujo 0.34l/min		

1 
imagen no disponible

código	371296	referencia	64002200
descripción	reducción velocidad de flujo 1.8l/min		
Para modelos:	AC125B, AC125C, AC175, AC225, ACM125, MC1210, MC15, MC45		

presostatos

para refrigeración

DANFOSS

1 

código	694092	referencia	19550618 CM19550618
descripción	presostato DANFOSS tipo KP5 60-5133 conexión de presión vertical refrigeración reinicio manual dif. conmutación 3bar margen de presión 8-32bar empalme 7/16" UNF (1/4" SAE)		
Para modelos:	MV50		

1 

código	542337	referencia	1113148
descripción	presostato DANFOSS tipo ACB-2UB126		

1 

código	541626	referencia	19550623 CM19550623
descripción	presostato dif. conmutación 30bar reinicio manual empalme de presión 6mm conexión para soldadura 250V longitud del cable 1500mm 1NC 6A		
Para modelos:	MV12		

1 

código	541824	referencia	l62045100
descripción	presostato empalme de presión 6mm conexión para soldadura tipo ACB-2UA426W 250V longitud del cable 2000mm 6A -30 a +85°C contactos 1NO		

1 

código	541625	referencia	1113061S&P
descripción	presostato empalme de presión 6mm conexión para soldadura tipo ACB-2UA462W 250V longitud del cable 1000mm 6A -30 a +85°C contactos 1NO		

RANCO

serie G23



1

código	695930	referencia	1100042521
descripción	presostato G23-5335-000 tubo ø 6,4mm		



1

código	541605	referencia	1100042622 11042622
descripción	presostato tipo G23-1000-35		
Para modelos:	CM500AE-1C, CM500AE-1D, CM500AE-1E		



1

código	541614	referencia	1100041022
descripción	presostato tipo G23-5334-000 margen de presión 10bar		

SAGI NO MIYA



1

código	539002	referencia	620075.02
descripción	presostato presión de conmutación 16bar reinicio automático tipo HTB-3UA12 empalme 2,4mm		
Para modelos:	ACM35, ACM45, ACM55, MAR125, MC1210, MF82, MF83		

JOHNSON CONTROLS



1

código	541116	referencia	1113111 62007500 62007505
descripción	presostato HD presión de conmutación 10bar reinicio automático dif. conmutacion 1.1bar margen de presión 7-29bar p máx. 38bar refrigeración tipo P20EA-9950C empalme conexión para soldadura 6,35mm CO JOHNSON CONTROLS empalme de presión conexión para soldadura 6,35mm		
Para modelos:	AC045, AC046, AC055, AC056, AC085, AC086, AC105, AC106, ACM45, ACM85, AF10, Barline-20, Barline-21, Barline-30, Barline-31, Barline-40, Barline-50, Barline-65, Barline-90, Barline-B40, Barline-BUL20, Barline-BUL30, Barline-BUL40, EC045, ICE-ONE, ICE-THREE, ICE-TWO, MAR5, SD18		



1

código	541117	referencia	1113038S&P 62023100 62023101
descripción	presostato HD presión de conmutación 24bar reinicio manual dif. conmutacion 4.7bar margen de presión 7-29bar p máx. 38bar refrigeración tipo P20GA-9950T empalme conector Faston 6,3mm CO JOHNSON CONTROLS empalme de presión conexión para soldadura 6,35mm		
Para modelos:	ACM35, ACM55, ACM85, AF20, AF30, MAR10, MAR125, MAR20, MAR30, MAR5, MF56ASR, MF66ASR, MF82		



1

código	541606	referencia	1100050821 11050821
descripción	presostato tipo P100AA-49 JOHNSON CONTROLS		
Para modelos:	CME256, CME506, CME656		



1

código	541604	referencia	1100050121 11050121
descripción	presostato tipo P100CA-27 JOHNSON CONTROLS		
Para modelos:	C0322, C0522, C1448, C1848, C2148, CME1056, CME1356, CME1656, CME256, CME306, CME456, CME506, CME656, CME806		



ROBERTSHAW



1

código	541615	referencia	1100044622
descripción	presostato tipo MG21-2077 ROBERTSHAW		



1

código	541607	referencia	1100048522 11048522
descripción	presostato tipo MG21-2110 ROBERTSHAW		
Para modelos:	CME1202, CME1202R, CME1402, CME1402R, MDT5N25A-1A, MDT5N25A-1B, MDT5N25A-6A, MDT5N25A-6B, MDT5N25W-1A, MDT5N25W-1B, MDT5N25W-6A, MDT5N25W-6B, MDT5N40A-1A, MDT5N40A-1B, MDT5N40A-6A, MDT5N40A-6B, MDT5N40W-1A, MDT5N40W-1B, MDT5N40W-6A, MDT5N40W-6B, NDE550AE-1A, NDE550AE-6A, NDE550WE-1A, NDE550WE-6A, NDE650AE-1A, NDE650AE-6A, NDE650WE-1A, NDE650WE-6A, TDE550AE-1A, TDE550AE-6A, TDE550WE-1A, TDE550WE-6A, TDE650AE-1A, TDE650AE-6A, TDE650WE-1A, TDE650WE-6A		



1

código	541616	referencia	1100047921
descripción	presostato tipo MG51-1108 ROBERTSHAW longitud del cable 700mm		

otros



1

código	542135	referencia	CM25474402
descripción	presostato reinicio manual empalme de presión 6mm conexión para soldadura dif. conmutación 45bar 250V longitud del cable 230mm 1NC 6A		
Para modelos:	MV1000, MV450, MV456, MV600, MV800		

compresores

ACC/ZEL

R134A

HMBP monofásico

Temperatura alta/media de evaporación superior a -20/-15 °C



1

código	605012	referencia	670100.02 670105.07 CM19165497
descripción	compresor refrigerante R134a tipo GL45TB 220-240V 50Hz HMBP completamente hermético 8.4kg 1/6HP consumo 342W capacidad cilindro 4.5 cm ³ CSIR H 175.5mmW 76W 101W 134W 175W 223W 278W 342W 413W metodo de test ASHRAE temperatura ambiente máx. 43°C		



1

código	605008	referencia	1137015 67009708
descripción	compresor refrigerante R134a tipo GL80TB 220-240V 50Hz HMBP completamente hermético 9.5kg 1/5HP consumo 554W capacidad cilindro 7.6 cm ³ CSIR H 175.5mm 165W 215W 290W 390W 500W 615W 727W 840W metodo de test ASHRAE temperatura ambiente máx. 43°C		
Para modelos:	ACM25, Barline-20, Barline-21, Barline-BUL20		



1

código	605011	referencia	67010001
descripción	compresor refrigerante R134a tipo GP14TB 220-240V 50Hz HMBP completamente hermético 11.5kg 3/8HP consumo 566W capacidad cilindro 14 cm ³ CSIR H 203.6mm 191W 271W 373W 497W 643W 810W 999W 1209W metodo de test ASHRAE temperatura ambiente máx. 43°C		



R404a/R507

HMBP monofásico

Temperatura alta/media de evaporación superior a -20/-15 °C



1

código	605072	referencia	1137030 67009904
descripción	compresor refrigerante R404a/R507 tipo MX18TBa 220-240V 50Hz HMBP completamente hermético 17.2kg 7/8HP capacidad cilindro 18.4 cm ³ CSR H 213mmW 640W 839W 1076W 1350W 1663W 2013W 2400W 2826W metodo de test ASHRAE temperatura ambiente máx. 43°C		
Para modelos:	AC225, AC226, MF41, MF46, MV450		
repuestos para	605072		
	código	referencia	—
	365006		
	condensador de servicio capacidad 16µF 400V tolerancia 5% 50/60Hz temperatura ambiente máx. -25 a + 85°C ø 35mm L 121mm M8 aluminio empalme cable 300mm MKP protección IP65		
	código	referencia	—
	365128		
	condensador de servicio capacidad 16µF 450V tolerancia 5% 50-60Hz temperatura ambiente máx. -25 a + 85°C ø 40mm L 100mm M8 aluminio empalme conector Faston 6,3mm 16.26.16 protección		

COPELAND

R404a/HP62



1

código	605097	referencia	1800875027
descripción	compresor refrigerante R404a/HP62 tipo CS18K6E-PFJ-276 220-240V 50Hz completamente hermético		



1

código	605096	referencia	1800872122
descripción	compresor refrigerante R404a/HP62 tipo RS55C1E-PAZ-213 220-240V 50Hz completamente hermético		

CUBIGEL

accesorios

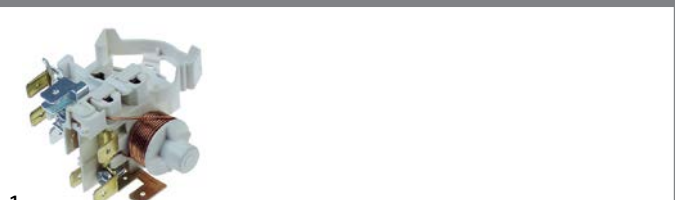

1

código	380576	referencia	62005731
descripción	relé de arranque		
Para modelos:	AC045, AC055, AC056, ACM45, ACM85, AF10, AF100, AF20, AF80, Barline-30, Barline-31, Barline-BUL30, EC045, ICE-ONE, ICE-TWO, MF20		



1

código	380586	referencia	62005732
descripción	relé de arranque 120/240V tensión AC 8A 1NO		
Para modelos:	ACM25, ACM35, ACM45, AF10		

1

código	380822	referencia	1109184 62005734
descripción	relé de arranque 120/240V tensión AC 8A 1NO		
Para modelos:	ACM55		



1

código	380575	referencia	62005749
descripción	relé de arranque MTRP5631		
Para modelos:	AC085, AC105, AF20, AF200, Barline-40, CD40, ICE-THREE		

L'UNITE HERMETIQUE / TECUMSEH

R134A

HBP monofásico

Temperatura alta de evaporación superior a -15°C



1

código	605095	referencia	67010102
descripción	compresor refrigerante R134a tipo AE4450Y-FZ 220-240V 50Hz HBP completamente hermético 11.5kg 3/8HP capacidad cilindro 13.2 cm ³ CSIR H 206mmWWW 526W 672W 843W 1042W 1273W 1540W metodo de test EN 12900		
Para modelos:	AC085, AC105, AF20, AF200, Barline-40, CD40, ICE-THREE		

HMBP monofásico

Temperatura alta/media de evaporación superior a -20/-15 °C



1

código	605160	referencia	67009902
descripción	compresor refrigerante R134a tipo CAJ4461Y 220-240V 50Hz HMBP 20kg 1/2HP consumo 728W capacidad cilindro 18.3 cm ³ CSIR H 258mmWW 475W 642W 856W 1115W 1421WW		

R404A

LBP trifásico

Temperatura baja de evaporación inferior a -20°C



1

código	605187	referencia	670099.15
descripción	compresor refrigerante R404A tipo TAJ2464Z 400V 50/60Hz LBP 22.5kg 1.5HP capacidad cilindro 34.4 cm ³ TRI H 282mm 1108W 1579W 1850W 2317W 2855WWWWW metodo de test EN 12900		

HMBP monofásico

Temperatura alta/media de evaporación superior a -20/-15 °C



1

código	605065	referencia	670099.05
descripción	compresor refrigerante R404A tipo CAJ4519Z 220-240V 50Hz HMBP 24kg 1.5HP capacidad cilindro 34.4 cm ³ CSR H 282mmWWW 1769W 2353W 3009W 3756W 4360W 5200W		
Para modelos:	MF51, MF56, MF56ASR, MV600		



HMBP trifásico

Temperatura alta/media de evaporación superior a -20/-15 °C



código	605037	referencia	67009801
descripción	compresor refrigerante R404A tipo FH4531Z 220-240V 50Hz HMBP 37kg 2 1/2HP capacidad cilindro 56.65 cm ³ CSR H 354mmWW 2619W 3491W 4469W 5574W 6826W 8245W 9853W metodo de test EN 12900		

accesorios

relé de arranque

Klixons

código	380582	referencia	62005701
descripción	relé de arranque Klixon 131 15A serie 9660B		
Para modelos:	ACM35, AF10		

código	380583	referencia	1105417 62005703
descripción	relé de arranque Klixon 145 serie 9660B		
Para modelos:	AC045, AC055, AC056, ACM85, AF20, Barline-30, Barline-31, EC045, ICE-ONE, ICE-TWO		

código	380856	referencia	62016801
descripción	relé de arranque Klixon 170 15A serie 9660A		
Para modelos:	AF30		

RBM

código	380595	referencia	1800190340
descripción	relé de arranque RBM 128306-1645PB		

código	380594	referencia	1800190329
descripción	relé de arranque RBM 128306-1653VB		

otros

código	380587	referencia	1109176 1800190356
descripción	relé de arranque 230V 1NC empalme conector Faston 6,3mm		

código	380581	referencia	62005741
descripción	relé de arranque 230V 1NO/1NC empalme conector Faston 6,3mm con lengüeta medidas 45x50x42mm		
Para modelos:	MC15, MC16		

resistencias

código	695807	referencia	62030500
descripción	resistencia 54W 240V longitud del cable 750mm para compresor TUTCO CH 101		
Para modelos:	MAR5		

interrupor térmico (klixon)



código	390654	referencia	4114757 62005868
descripción	interrupor térmico		
Para modelos:	AC175, AF200, MF22, MF26		



código	390640	referencia	62005878
descripción	interrupor térmico para protección de motor térmica con cable reinicio automático		
Para modelos:	AC125, AC126, AC225, AC226, ACM125, ACM175, Barline-65, MF41, MF46		



código	390651	referencia	62005846
descripción	interrupor térmico para protección de motor térmica MRA38031-3007 con cable T máx 145°C reinicio automático		
Para modelos:	ACM55, ACM85, AF20		



código	390544	referencia	62005855
descripción	interrupor térmico para protección de motor térmica T0168/22 con cable T máx 150°C reinicio automático		
Para modelos:	ACM55		



código	390608	referencia	62005880
descripción	interrupor térmico para protección de motor térmica T0418/A4		
Para modelos:	AC085, AC105, AF20, AF200, Barline-40, CD40, ICE-THREE		



código	390666	referencia	1200230003 12230003
descripción	interrupor térmico para protección de motor térmica L140-20F 8926 longitud del cable 90mm		
Para modelos:	CM250A, CM250C, CM250D, CM250E, CM450E, CM500AE-1D, CM500AE-1E, CM500R, CM550, CM650A, CM650C, CM650D, CM650RA, CM650RC, CM650RD, CM650RE, CME250, CME500, CME500R, CME650, CME650R		

ventiladores





ventiladores para frigoríficos





motores refrigeración universales

ELCO

serie N - multianclaje



código	601427	referencia	18562496 62000310 62000322 62041902 70413406 70413412 CM18562496
descripción	motor de ventilador ELCO 10W 230V 50/60Hz cojinete cojinete de fricción L1 49mm L2 59mm L3 86.5mm An 83mm empalme cable 500mm 1300/1550rev/min 5 opciones de montaje VNT10-20/028		
Para modelos:	AC045, AC046, AC055, AC056, AC085, AC086, AC105, AC106, AC125, AC125B, AC125C, AC126, AC175, ACM125, ACM175, ACM45, ACM55, ACM85, AF10, AF100, AF20, AF200, AF30, AF80, Barline-20, Barline-30, Barline-31, Barline-40, Barline-50, Barline-65, Barline-90, Barline-B40, Barline-B65, Barline-BUL20, Barline-BUL30, Barline-BUL40, Barline-BUL65, EC045, ICE-ONE, ICE-THREE, ICE-TWO, MF20, MF22, MF26, MF30, MF36, SD18		
repuestos para	601427		
	código	560140	referencia —
	tuerca hexagonal rosca M4 H 4.8mm inox EC 7 UE 20 pzs DIN/ISO DIN 985 autobloqueo		
	código	560332	referencia —
	arandela int.ø 4.3mm ø ext. 9mm espesor 0.8mm inox UE 1 pzs		
	código	560340	referencia —
	tuerca hexagonal rosca M4 H 3.2mm EC 7 inox DIN/ISO DIN 934 / ISO 4032/8673 UE 1 pzs		
	código	601413	referencia —
	placa de sujeción apto para rodete ventilador ø ext. 32mm eje ø 7 distancia de sujeción 26mm		

			
1			
código	601430	referencia	62000313 62041900 CS1761101602
descripción	motor de ventilador ELCO 5W 230V 50/60Hz cojinete cojinete de fricción L1 48mm L2 52mm L3 79.5mm An 83mm empalme cable 500mm 1300/1550rev/min 5 opciones de montaje VNT5-13/027		
Para modelos:	ACM25, ACM35, Barline-21, MV12, MV450, MV600, SCW14B, SCW14S, SW12		
repuestos para	601430		
	código	560140	referencia —
		tuerca hexagonal rosca M4 H 4.8mm inox EC 7 UE 20 pzs DIN/ISO DIN 985 autobloqueo	
	código	560332	referencia —
		arandela int.ø 4.3mm ø ext. 9mm espesor 0.8mm inox UE 1 pzs	
	código	560340	referencia —
		tuerca hexagonal rosca M4 H 3.2mm EC 7 inox DIN/ISO DIN 934 / ISO 4032/8673 UE 1 pzs	
	código	601413	referencia —
		placa de sujeción apto para rodetes ventilador ø ext. 32mm eje ø 7 distancia de sujeción 26mm	

serie N - estándar

			
1			
código	601527	referencia	18562444 CM18562444
descripción	motor de ventilador 16W 230V 50/60Hz An 84mm 1300rev/min VN16-38		

IMPORTACIÓN			
motores multianclaje			
			
1			
código	601023	referencia	62023300 62030006 62041300 62041904
descripción	motor de ventilador 16W 230V 50-60Hz L1 45mm L2 61mm L3 92mm An 84mm longitud del cable 500mm 1300rev/min YZF16-25-18/26 5 opciones de montaje cojinete cojinete de fricción		
Para modelos:	AC175, AC176, AC225, AC226, ACM125, ACM175, ACM45, Barline-90, Barline-B90, Barline-BUL90, MC15, MC16, MC45, MC46, MCB, MF41, MF46		

otros

			
1			
código	601558	referencia	1200212106 62023302
descripción	motor de ventilador 16W 220V 60Hz An 84mm 1300rev/min		
Para modelos:	AC225, MC15		

			
1			
código	601431	referencia	1103497S&P 60413.00 62041906 62041907
descripción	motor de ventilador 35W 230V		
Para modelos:	MF51, MF56		



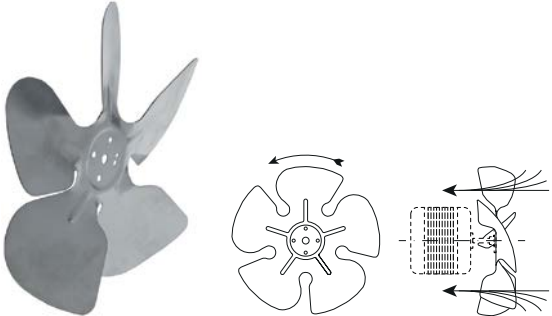

1

código	601524	referencia	CM1856524
descripción	motor de ventilador 35W 230V 50/60Hz L3 153mm An 83mm longitud del cable 1600mm 1300rev/min con condensador condensador 2.5µF		

accesorios**rodetes de ventilador****aluminio**

1

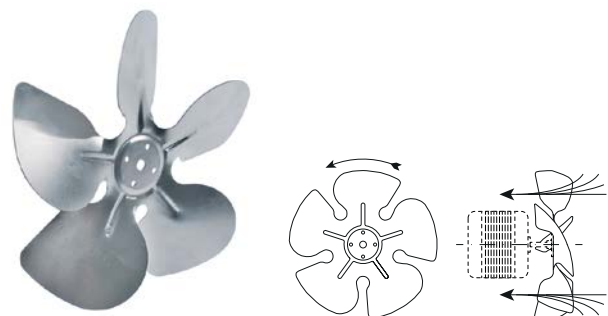
código	601070	referencia	62000705
descripción	rodete ventilador aspirante ø 200mm fijación asta 25.4mm inclinación de la pala 28° An 38mm aluminio		
Para modelos:	ACM35		



1

código	601282	referencia	62000707 62041932
descripción	rodete ventilador aspirante ø 200mm fijación asta 25.4mm inclinación de la pala 34° An 44mm aluminio		
Para modelos:	AC045, AC046, AC055, AC056, AC125B, AC125C, AC175, ACM125, ACM45, ACM85, AF10, AF100, AF20, AF80, Barline-20, Barline-21, Barline-30, Barline-31, Barline-BUL20, Barline-BUL30, EC045, ICE-ONE, ICE-TWO, MF20, MF30, MV12, MV450, MV600, SD18		

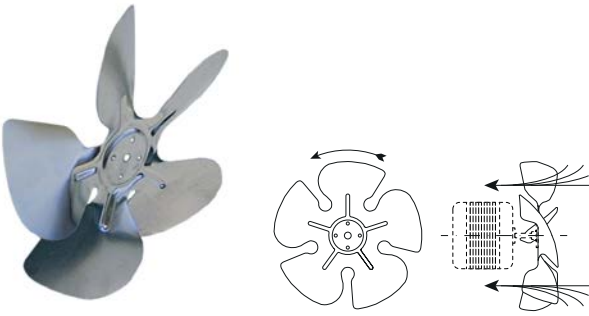

1

código	601071	referencia	62000703 620419.31
descripción	rodete ventilador aspirante ø 230mm fijación asta 25.4mm inclinación de la pala 25° An 37mm aluminio		
Para modelos:	ACM45, ACM55, ACM85		

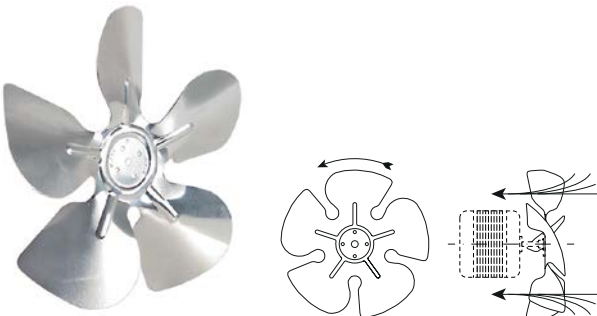

1

código	601283	referencia	62041933
descripción	rodete ventilador aspirante ø 230mm fijación asta 25.4mm inclinación de la pala 28° An 41mm aluminio		
Para modelos:	AC085, AC086, AC105, AC106, AC125, AC126, AC175, AC176, ACM125, ACM175, AF20, AF200, AF30, Barline-40, Barline-50, Barline-65, Barline-90, Barline-B40, Barline-B65, Barline-B90, Barline-BUL40, Barline-BUL65, Barline-BUL90, ICE-THREE, MF22, MF26, MF30, MF36		

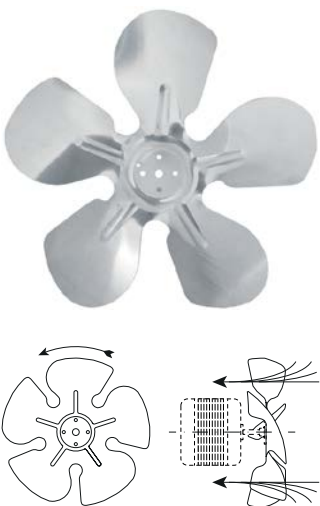

1

código	601387	referencia	62000000 62003901 62041934
descripción	rodete ventilador aspirante ø 254mm fijación asta 25.4mm inclinación de la pala 34° An 50mm aluminio		
Para modelos:	AC225, AC226, MC15, MC16, MC45, MC46, MC8, MF41, MF46		



1

código	601555	referencia	6200001
descripción	rodete ventilador aspirante ø 300mm fijación asta 25.4mm inclinación de la pala 25° An 45mm aluminio		

1

código	601542	referencia	1800876501 1800887501
descripción	rodete ventilador aspirante ø 350mm An 86mm aluminio		

1

código	601534	referencia	62027401
descripción	rodete ventilador ø 410mm An 80mm soporte de eje ø 13mm		
Para modelos:	MAR10, MAR125, MAR30, MAR5, MF82, MF83		

aluminio

1

código	601556	referencia	18740040 CM18740040
descripción	rodete ventilador soplado ø 254mm fijación asta 25.4mm inclinación de la pala 31° An 46mm aluminio		
Para modelos:	MV18-21, MV25-32		

ventiladores de refrigeración varios

1

código	601540	referencia	1800550501
descripción	motor de ventilador 115V 60Hz An 98mm H 97mm P 155mm eje L 40mm eje ø 10mm GARRETT longitud del cable 100mm 1500rev/min		

1

código	601554	referencia	620273.00 620273.03 620490.00
descripción	motor de ventilador 230V 50-60Hz 100W An 105mm H 105mm P 220mm eje L 80mm eje ø 12mm EURO MOTORS tipo 10111-40100 longitud del cable 1500mm 1100rev/min		

1

código	601533	referencia	1800874002
descripción	motor de ventilador 230V 50Hz An 95mm H 97mm P 165mm eje L 40mm eje ø 9mm GARRETT longitud del cable 1250mm 1250rev/min		



ventiladores tangenciales

COPREL

con bobina estándar



1

código	601453	referencia	91476111
descripción	ventilador tangencial TFR 180 rodillo \varnothing 60mm L rodillo 180mm espesor de núcleo laminado 16mm posición del motor derecho 230V/50-60Hz 17W universal cojinete silicona empalme conector Faston 6,3mm caudal 100m ³ /h -30 a +100°C 230V 50Hz		
accesorios para	601453		
	código	415114	referencia
			—
	registro de calefacción distancia de sujeción 185mm An 40mm H 35mm 2000W 230V limitación de temperatura 105°C espirales 2 empalme cable longitud del cable 150mm L 192mm para soplador transversal		

con bobinas moldeadas



1

código	601547	referencia	91476110
descripción	ventilador tangencial COPREL FFR rodillo \varnothing 60mm L rodillo 90mm espesor de núcleo laminado 15mm posición del motor derecho 230V/50Hz 18W refrigeración cojinete goma empalme cable 1000mm tipo de bobina moldeado -10 a +60°C		

ventiladores radiales

otros



1

código	601523	referencia	CM18562443
descripción	ventilador radial 230V tensión AC 50Hz 50W H1 175mm L1 165mm D1 \varnothing 83mm B1 160mm B2 73mm H2 60mm B3 82mm H3 96mm		

motores

motorreductores

para máquina de hielo en cubitos

para paleta



1

código	501472	referencia	IOM916103101
descripción	motorreductor CROUZET tipo SP-1905-40 3W 230V 50-60Hz 2rev/min eje \varnothing 5x4mm ancho de ranura 17mm árbol \varnothing 4.7mm máquina de hielo		



1

código	500407	referencia	CM19440059
descripción	motorreductor LIP tipo 123MR 8W 220/240V tensión AC 50/60Hz 50rev/min sentido de rotación en sentido anti-horario eje \varnothing 4mm soporte de eje \varnothing 6.2mm ancho de ranura 2.3mm eje L 8mm árbol \varnothing 4mm An 74mm		

para cubetas



1

código	500410	referencia	CM19440065
descripción	motor de cubeta LIP 11W 230V 50Hz 0.7rev/min árbol \varnothing 7mm longitud árbol 20mm An 72mm H 110mm 010		



1

código	500786	referencia	CM81404024
descripción	motor de cubeta LIP 11W 230V 50Hz 1rev/min árbol ø 8mm An 100mm H 90mm para máquina de hielo L 130mm		
repuestos para	500786		
	código	referencia	CM252600000
	arandela para basculación cuba ø 100mm soporte de eje ø 7mm		



1

código	500409	referencia	CM19440063
descripción	motor de cubeta LIP tipo 001 11W 220/240V tensión 50/60 0.7rev/min árbol ø 7mm longitud árbol 20mm An 71mm H 62mm L 110mm		



1

código	500411	referencia	CM19440057
descripción	motorreductor BITRON tipo 97103 11W 230V 50Hz 0.7rev/min árbol ø 7mm longitud árbol 30mm An 72mm H 60mm L 116mm		



1

código	500412	referencia	CM19440073
descripción	motorreductor LIP tipo 021B 11W 230V 50Hz 1rev/min árbol ø 7mm longitud árbol 20mm An 74mm P 67mm H 110mm para cubeta		

otros



1

código	601539	referencia	81401520 CM81401520
descripción	motorreductor LIP tipo 049E 80W 230V 50Hz 13rev/min árbol ø 18mm L 160mm An 74mm H 160mm para esparrago		
Para modelos:	CD40		



1

código	500739	referencia	02474305 0A02474305
descripción	motorreductor MERKLE-KORFF 6W 115V 50Hz 39rev/min árbol ø 8mm L 140mm An 85mm H 85mm para máquina de hielo		



1

código	601518	referencia	1200161006
descripción	motorreductor MERKLE-KORFF tipo 3724UP-350 230V 50/60Hz árbol ø 9mm L 145mm An 75mm H 85mm		



1

código	500775	referencia	02465606 0A02465606
descripción	motorreductor MK 230V 50Hz árbol ø 9.1mm L 85mm An 85mm H 116mm para máquina de hielo		

			
1			
código	500773	referencia	1200240726
descripción	motorreductor tipo S5814A 230V árbol ø 5mm L 170mm An 75mm H 120mm		

motores

para máquina de hielo en cubitos

completo

			
1			
código	500745	referencia	06027303
descripción			

			
1			
código	500778	referencia	1200064306
descripción	motor 180W 110/230V 50Hz fases 1 árbol ø 12.8mm 1425rev/min tipo SKC37MG180FT GENERAL ELECTRIC 0.18kW		

rotores

			
1			
código	500751	referencia	4114490 79412303R
descripción	rotor ø 65mm árbol ø 13mm longitud árbol 180mm para fabricante de hielo en escamas		
Para modelos:	AF10, AF100, AF20, AF200, AF30, AF80, MF20, MF22, MF26, MF30, MF36		

			
1			
código	500774	referencia	79421600R
descripción	rotor ø 79mm árbol ø 16mm longitud árbol 52mm para fabricante de hielo en escamas		
Para modelos:	MF41, MF46, MF51, MF56, MF56ASR, MF61, MF62, MF66, MF66ASR		

estatores

			
1			
código	695826	referencia	62029500
descripción	estátor 230V 50/60Hz fases 1 ø 135mm int.ø 80mm H 45mm con carcasa		
Para modelos:	MF41, MF46, MF51, MF56, MF56ASR, MF61, MF62, MF66, MF66ASR		

			
1			
código	500747	referencia	00140026 1200140026
descripción	estátor 230V 50Hz fases 1 ø 101mm int.ø 59mm H 51mm		

universal

			
1			
código	500744	referencia	62048001
descripción	motor 550W 230/400V 50Hz fases 3 árbol ø 19mm brida ø 120mm 1400rev/min tipo BN80A4 ø 150mm H 200mm L 240mm BONFIGLIOLI 0.55kW		
Para modelos:	MF82, MF83		



1

código	500767	referencia	62038302
descripción	motor 550W 230/400V 60Hz fases 3 árbol ø 19mm 900rev/min tipo H80B6 ø 155mm H 160mm L 240mm medida de sujeción 100x125mm COEL 0.55kW		



1

código	500734	referencia	0A02982901
descripción	bomba BECKETT tipo U62 230V 50/60Hz entrada ø 19mm salida ø 19mm L 128mm dirección de rodadura derecho para máquina de hielo		

bombas

bombas para máquinas de cubitos de



1

código	695417	referencia	Z11D043
descripción	aislamiento para bomba		



1

código	500753	referencia	1200225622
descripción	bomba BECKETT tipo U62 230V 50/60Hz entrada ø 25mm salida ø 25mm L 130mm dirección de rodadura derecho para máquina de hielo en cubitos condensador 4µF		



1

código	500760	referencia	1200258621
descripción	bomba BECKETT tipo U21 11W 115V 60Hz salida ø 16mm L 120mm dirección de rodadura derecho para máquina de hielo		



1

código	500758	referencia	1200258221
descripción	bomba BECKETT tipo U62 230V 50/60Hz salida ø 25mm L 120mm dirección de rodadura derecho para máquina de hielo condensador 4µF		



1

código	500776	referencia	1200258624
descripción	bomba BECKETT tipo U21 11W 115V 60Hz salida ø 19mm L 124mm dirección de rodadura derecho para máquina de hielo		



1

código	500764	referencia	62023800 67000200
descripción	bomba COEL tipo MH40F 35W 230V 50Hz entrada ø 19mm salida ø 19mm L 125mm dirección de rodadura derecho para máquina de hielo		



1

código	500200	referencia	Z1ID005
descripción	bomba GRE 100W 230V 50Hz entrada ø 24mm salida ø 23mm L 145mm dirección de rodadura derecho		



1

código	500759	referencia	1103465 62043301
descripción	bomba GRE 30W 230V 60Hz salida ø 12.5mm L 137mm dirección de rodadura derecho para máquina de hielo		
Para modelos:	AC045, AC046, AC055, AC056, AC085, AC086, AC105, ACM25, Barline-20, Barline-21, Barline-30, Barline-31, Barline-40, Barline-50, EC045, ICE-ONE, ICE-THREE, ICE-TWO, MV1000, MV300, MV450, MV600, MV800		





1

código	500752	referencia	62043002
descripción	bomba GRE 60W 230V 60Hz entrada ø 16mm salida ø 21mm L 110mm dirección de rodadura derecho para máquina de hielo		
Para modelos:	AC225, AC226, MC1210, MC15, MC16, MC45, MC46, MC8		



1

código	500045	referencia	06049103 62041500 Z1D009
descripción	bomba GRE tipo 100W 230V 50Hz entrada ø 24mm salida ø 21mm L 150mm dirección de rodadura izquierdo para máquina de hielo en cubitos longitud total 230mm		
repuestos para	500045		
	código	532082	referencia —
	junta tórica EPDM espesor 2.62mm int.ø 61.6mm UE 10 pzs		

accesorios para	500045		
	código	695417	referencia Z1ID043
	aislamiento para bomba		



1

código	501470	referencia	1103494 620423.00
descripción	bomba GRE tipo 100W 230V 50Hz salida ø 13mm L 137mm dirección de rodadura izquierdo máquina de hielo		



1

código	500777	referencia	62047100
descripción	bomba GRE tipo CL.F 100W 230V 50Hz entrada ø 20mm salida ø 11mm L 140mm dirección de rodadura derecho para máquina de hielo en cubitos		
Para modelos:	EC045		



1

código	500597	referencia	62043003
descripción	bomba GRE tipo MH50F 60W 230V 50Hz salida ø 21mm L 110mm dirección de rodadura derecho para máquina de hielo		
Para modelos:	AC125, AC175, Barline-65, Barline-90, Barline-B65, Barline-B90, Barline-BUL65, Barline-BUL90		



1

código	500772	referencia	1200258625
descripción	bomba HARTELL tipo U21B 230V 50/60Hz salida ø 19mm L 120mm dirección de rodadura derecho para máquina de hielo en cubitos Jan 30HP		



1

código	500763	referencia	1103544 1200258623
descripción	bomba HARTELL tipo U21B 25W 230V 50/60Hz salida ø 19mm L 120mm para máquina de hielo 0.33HP condensador 12.5µF		



1

código	499005	referencia	1103590 1200226022 12-2260-22
descripción	bomba HARTELL tipo U21B 75W 240V 50/60Hz salida ø 12mm L 120mm para máquina de hielo		
Para modelos:	CM450E		



1

código	500750	referencia	1200241962 12241962
descripción	bomba MORRILL tipo MSP 230V 50/60Hz salida ø 21/27mm L 115mm dirección de rodadura derecho		
Para modelos:	CM1000, CME1000A, CME1002R, CME1002W, CME855A, CME865R, CME865W, CMS1002R, CMS1002W, MCM1062R, MCM1062W, MC-M860R, MCM860W		



1

código	500047	referencia	1103066S&P 62028300 62028308 62043300 79311300
descripción	bomba REBO tipo MH30F1 30W 230V 50Hz salida ø 12.7mm L 135mm dirección de rodadura izquierdo		
Para modelos:	ACM55, ACM85, MV18, MV25		



1

código	500761	referencia	62043300 62043302 62043307 79311309
descripción	bomba REBO tipo MH30F1 30W 230V 50Hz salida ø 13mm L 135mm dirección de rodadura derecho para máquina de hielo		
Para modelos:	AC045, AC046, AC055, AC056, AC085, AC086, AC105, AC106, ACM25, Barline-20, Barline-21, Barline-30, Barline-31, Barline-40, Barline-50, Barline-B40, Barline-BUL20, Barline-BUL30, Barline-BUL40, CD40, EC045, ICE-ONE, ICE-THREE, ICE-TWO, MAR125, MV1000, MV12, MV18, MV18-21, MV25, MV25-32, MV300, MV450, MV50, MV600, MV800, SD18		



1

código	500769	referencia	79311304 79311317R
descripción	bomba REBO tipo MH50F 60W 115V 60Hz salida ø 18mm L 135mm dirección de rodadura derecho para máquina de hielo		
Para modelos:	AC125B, ACM125		



1

código	501471	referencia	79311324R
descripción	bomba REBO tipo MH50F 60W 220-240V 50Hz salida ø 18.5mm L 136mm dirección de rodadura izquierdo máquina de hielo		
Para modelos:	MV50		



1

código	500204	referencia	1103068S&P 67000206
descripción	bomba REBO tipo MH50F 60W 230V 50Hz entrada ø 19mm salida ø 19mm L 125mm dirección de rodadura derecho para máquina de hielo en cubitos		



1

código	500048	referencia	1103064S&P 1103533S&P 7911303 7911303R 7931130
descripción	bomba REBO tipo MH50F 60W 230V 50Hz salida ø 18mm L 137mm dirección de rodadura derecho para máquina de hielo		



1

código	501498	referencia	79311312 79311312R
descripción	bomba REBO tipo MH50F 60W 230V 50Hz salida ø 18mm L 137mm dirección de rodadura derecho para máquina de hielo		



1

código	500746	referencia	1103499S&P 62043006
descripción	bomba REBO tipo MH50F 60W 230V 50Hz salida ø 20mm L 110mm dirección de rodadura derecho para máquina de hielo en cubitos		
Para modelos:	AC125, AC126, AC175, AC176		



1

código	500203	referencia	1103067S&P 1103075 62043000 67000212 72312303 73154111 79314600
descripción	bomba REBO tipo MH50F 60W 230V 50Hz salida ø 21mm L 110mm dirección de rodadura derecho para máquina de hielo		
Para modelos:	AC225, AC226, MC1210, MC15, MC16, MC45, MC46, MC8		



1

código	501481	referencia	81454637-0
descripción	bomba REBO tipo NR40 40W 220/240V 50Hz salida ø 12.7mm L 275mm dirección de rodadura izquierdo		



1

código	500046	referencia	0A030625.02 1103065S&P 67003606
descripción	bomba REBO tipo NR40 40W 230V 50Hz entrada ø 12mm salida ø 12mm L 75mm dirección de rodadura derecho para máquina de hielo en cubitos		
Para modelos:	ACM35		



1

código	500771	referencia	62023807
descripción	motor de boma 115V 60Hz L 105mm An 78mm H 110mm árbol ø 7mm longitud árbol 110mm		

condensadores y filtros antiparasitarios

condensadores de arranque

condensadores de arranque



1

código	365100	referencia	62016717
descripción	condensador de arranque 160V 60Hz FACON capacidad 156µF		
Para modelos:	AF20		



			
1			
código	365102	referencia	19180567 CM19180567
descripción	condensador de arranque 330V 50Hz con resistencia ciclo de trabajo 3/1,7% capacidad 88µF		
Para modelos:	MV18, MV25		

			
1			
código	365094	referencia	62016701 62016702
descripción	condensador de arranque 330V capacidad 64µF		
Para modelos:	AC085, AC105, AC125, AC126, AC175, AC176, AC225, AC226, ACM125, ACM175, AF10, AF20, AF30, Barline-20, Barline-21, Barline-40, Barline-65, Barline-90, Barline-B40, Barline-B65, Barline-B90, Barline-BUL40, Barline-BUL65, Barline-BUL90, CD40, ICE-THREE, MF30, MF36, MV12, MV300, MV450		

			
1			
código	365101	referencia	19180508 CM19180508
descripción	condensador de arranque 330V ciclo de trabajo 1.7% capacidad 125µF		

			
1			
código	365096	referencia	62016700
descripción	condensador de arranque 88µF 330V		
Para modelos:	AC175, AC176, AC225, AC226, Barline-90, MC15, MC16, MF30, MF36, MF41, MF46, MF51, MF56, MF56ASR, MV18-21, MV300, MV450, MV600		

			
1			
código	365095	referencia	62016729
descripción	condensador de arranque 43µF 330V 50/60Hz ciclo de trabajo 3 60A1D330043NXET ø 36mm L 80mm M8 plástico empalme cable 350mm 04P.5523CM		
Para modelos:	AC045, AC046, AC055, AC056, AC085, AC086, AC105, AC106, AC175, ACM45, ACM85, AF10, AF100, AF20, AF200, AF80, Barline-20, Barline-21, Barline-30, Barline-31, Barline-40, Barline-50, Barline-BUL20, Barline-BUL30, EC045, ICE-ONE, ICE-THREE, ICE-TWO, MC8, MF20, MF22, MF26, SD18		

condensadores de arranque electrolíticos			
			
1			
código	365098	referencia	62016707
descripción	condensador de arranque 320V 50/60Hz electrolítico capacidad 125µF		
Para modelos:	MV25-32		

condensadores de servicio plástico			
			
1			
código	365018	referencia	620167.24 620167.54
descripción	condensador de servicio capacidad 35µF 400V tolerancia 5%Hz temperatura ambiente máx. -25 a + 85°C ø 45mm L 95mm M8 plástico empalme conector Faston 6,3mm protección		

			
1			
código	365031	referencia	62029204
descripción	condensador de servicio capacidad 4µF 450V tolerancia 5% 50/60Hz temperatura ambiente máx. -25 a + 85°C ø 31mm L 58mm M8 plástico empalme conector Faston 6,3mm protección		
Para modelos:	AF10, AF100, AF20, AF200, AF30, AF80, MF20, MF22, MF26, MF30, MF36		

metal			
			
1			
código	365204	referencia	1800190152
descripción	condensador de servicio capacidad 15µF 400V tolerancia 10% 50-60Hz temperatura ambiente máx. -40 a +85°C ø 35mm L 135mm M8 aluminio empalme cable 630mm		



			
1			
código	365099	referencia	1800190230
descripción	condensador de servicio capacidad 15µF 440V con revestimiento metálico		

			
1			
código	365036	referencia	62016725
descripción	condensador de servicio capacidad 20µF 450V tolerancia 5% 50/60Hz temperatura ambiente máx. -25 a + 85°C ø 35mm L 120mm M8 aluminio empalme cable 300mm MKP protección IP65		
Para modelos:	MC15		

			
1			
código	365037	referencia	1800190228 1800190253 62017101
descripción	condensador de servicio capacidad 30µF 450V tolerancia 5% 50/60Hz temperatura ambiente máx. -25 a + 85°C ø 35mm L 120mm M8 aluminio empalme cable		
Para modelos:	MV25-32		

fusibles

fusibles finos

			
1			
código	358611	referencia	63001510
descripción	fusible fino medida ø5x20mm 16A rápido nominal 250V UE 10 pzs		
Para modelos:	AC045, AC055, AC085, AC105, AC125, AC125B, AC125C, AC175, AC225, ACM125, ACM175, ACM35, ACM45, ACM55, ACM85, AF10, AF100, AF20, AF200, AF30, AF80, Barline-B40, Barline-B65, Barline-B90, Barline-BUL20, Barline-BUL30, Barline-BUL40, Barline-BUL65, Barline-BUL90, MC1210, MC15, MC45, MF20, MF30, MF61		

			
1			
código	358509	referencia	63001511
descripción	fusible fino medida ø5x20mm 0.05A retardado nominal 250V UE 1 pzs		
Para modelos:	AC045, AC055, ACM35, ACM45, ACM55, Barline-BUL20, Barline-BUL30		

			
1			
código	358592	referencia	63001509
descripción	fusible fino medida ø5x20mm 0.1A retardado nominal 250V UE 10 pzs		
Para modelos:	AC085, AC105, AC125, AC125B, AC125C, AC175, AC225, ACM125, ACM175, ACM85, AF10, AF100, AF20, AF200, AF30, AF80, Barline-B40, Barline-B65, Barline-B90, Barline-BUL40, Barline-BUL65, Barline-BUL90, MC1210, MC15, MC45, MF20, MF30, MF41, MF51, MF61		

accesorios eléctricos

cables

cables de cinta plana

grupo 2

			
1			
código	694124	referencia	62047001
descripción	cable de cinta plana 4 polos L 800mm		
Para modelos:	EC045		

grupo 7

			
1			
código	694212	referencia	29015064 CM29015064
descripción	cable de cinta plana 3 polos L 150mm para test		

			
1			
código	401818	referencia	62040407
descripción	cable de cinta plana 4 polos L 1000mm		
Para modelos:	MF61		

mazos de cables

			
1			
código	695947	referencia	1200261901
descripción	mazo de cables		



1

código	694188	referencia	1200240201 4217037
descripción	mazo de cables 3 polos L 170mm temperatura constante 105°C tipo de conector Faston 6,3mm		
accesorios para	694188		
	código	347064	referencia
			1105351 1200241101
descripción	interruptor basculante medida de montaje 40x18mm negro 1CO 250V 10A		

1

código	694097	referencia	62040417
descripción	mazo de cables 4 polos L 500mm		

cables de enlace

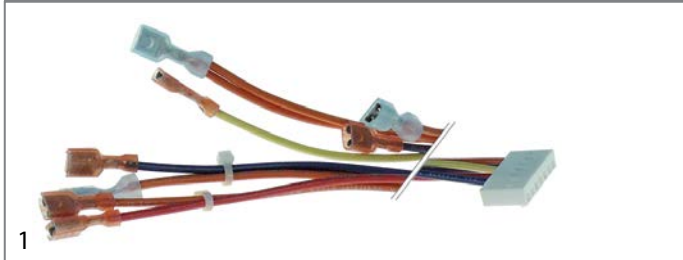

código	401796	referencia	1200247521
descripción	cable de conexión L 690mm empalme conector Faston 6,3mm		

1

código	701450	referencia	CM81455102
descripción	cable de enlace L 1300mm 2 polos sensor de nivel apto para máquina de hielo en cubitos empalme conector tipo de conector conector codificado		

terminales de cable y conectores

sin aislar

fundas protectoras

1

código	358002	referencia	63010500
descripción	funda protectora tamaño 6.3mm para faston macho plástico		

terminales

regletas de bornes con contactos de enchufe

1

código	550989	referencia	63011401
descripción	regleta de bornes 4 polos máx. 25A máx. 450V empalme F6,3/F6,3 resis.a la temp. 90°C sección nominal 2,5/4mm ²		
Para modelos:	AC046, AC056, AC086, ACM55, Barline-20, Barline-21, Barline-30, Barline-31, Barline-40, ICE-ONE, ICE-THREE, ICE-TWO, MAR30, MF82		

1

código	550785	referencia	63007002
descripción	regleta de bornes 7 polos máx. 20A máx. 450V empalme F6,3/F6,3 resis.a la temp. 90°C		

regletas de bornes con compensador de tracción

1

código	550356	referencia	63010700
descripción	borne de conexión 2 polos máx. 450V máx. 16A ø cable 15mm sección nominal 1.5mm ²		

componentes electrónicos

fotocélulas

1

código	541627	referencia	33580092 CM33580092
descripción	fotocélula cuadrado L 40mm An 25mm H 40mm para máquina de hielo		
Para modelos:	CD40		

1

código	541611	referencia	62044802
descripción	fotocélula derecho cuadrado empalme azul L 40mm An 25mm H 40mm para máquina de hielo		



código	541608	referencia	33580091 62044803 CM33580091
descripción	fotocélula izquierda cuadrado empalme negro L 40mm An 25mm H 40mm para máquina de hielo		
Para modelos:	CD40		



código	695748	referencia	66038701
descripción	tubo de rebose para máquina de hielo int.ø 16mm ø ext. 24mm L 87mm		
Para modelos:	ACM45, ACM55, ACM85		

componentes específicos para máquina de hielo en cubitos

sistemas de desagüe

piletas de desagüe



código	696583	referencia	CM25685311
descripción	pileta de desagüe ø 50mm rosca 3/4 tubo ø 21mm L 55mm recto para máquina de hielo en cubitos		
Para modelos:	B190, B193, B390, B393		



código	696609	referencia	66060100
descripción	tubo de rebose para máquina de hielo tubo ø 20mm longitud de tubo 24mm ø ext. 24.5mm L 109mm		
Para modelos:	Barline-BUL40		

filtros



código	695769	referencia	02002809.01 02-2809-01 66021101
descripción	filtro de desagüe rosca 7/8" ø 32mm H 10mm		
Para modelos:	AC045, AC046, AC055, AC056, AC085, AC086, AC105, AC106, AC125, AC125B, AC125C, AC126, AC175, AC176, AC225, AC226, ACM125, ACM175, ACM35, ACM45, ACM55, ACM85, AF10, AF20, AF30, B350, B550, Barline-21, Barline-31, Barline-40, Barline-50, Barline-65, Barline-90, Barline-B40, Barline-B65, Barline-B90, Barline-BUL40, Barline-BUL65, Barline-BUL90, EC045, ICE-ONE, ICE-THREE, ICE-TWO, MAR1, MAR10, MAR125, MAR2, MAR20, MAR3, MAR30...(Otros modelos se puede ver en la tienda web)		



código	695790	referencia	66069802
descripción	tubo de rebose tubo ø 19mm longitud de tubo 70mm		
Para modelos:	AC105, AC125, AC175, Barline-50, Barline-65, Barline-90		

rompes hielo



código	695658	referencia	65076800
descripción	rompe hielo int.ø 22mm ø ext. 118mm H 110mm		

tubos de rebose





código	695047	referencia	3124070S&P 660219.01
descripción	tubo de rebose L 78mm recto		
Para modelos:	AC045, AC046, AC055, AC056, AC085, AC105, AC125, AC125B, AC125C, AC175, ACM125, ACM175, ACM45, ACM55, ACM85, AF10, Barline-40, Barline-50, Barline-65, Barline-90, Barline-B40, Barline-B65, Barline-B90, Barline-BUL40, Barline-BUL65, Barline-BUL90, EC045, ICE-ONE, ICE-THREE, ICE-TWO, MAR10, MAR20, MAR30, MAR5, RB400, SD18		



código	695962	referencia	01467820 0A01467820
descripción	rompe hielo int.ø 26mm ø ext. 51mm H 58mm latón completo		
repuestos para	695962		
	código	523511	referencia 03289830 0A03289830 65105300
	código	532518	referencia 1300061716



			
1			
código	695629	referencia	75400102
descripción	rompe hielo int.ø 26mm ø ext. 51mm H 59mm latón		
Para modelos:	AF10, AF100, AF20, AF200, AF30, MF20, MF22, MF26, MF30, MF36		

			
1			
código	696436	referencia	06072000 75400101
descripción	rompe hielo int.ø 26mm ø ext. 51mm H 59mm latón con rodamiento de bolas		
Para modelos:	AF10, AF20, AF30, AF80, MF30		

			
1			
código	695594	referencia	75100501
descripción	rompe hielo int.ø 36mm ø ext. 140mm H 67mm pos. de montaje arriba		
Para modelos:	MF41, MF46, MF51, MF56, MF56ASR, MF61, MF62, MF66, MF66ASR		

			
1			
código	695625	referencia	0A03257120
descripción	rompe hielo int.ø 71mm ø ext. 132mm H 47mm		

conductos hielo

canal de expulsión

			
1			
código	694125	referencia	06055000
descripción	canal de expulsión L 785mm An 90mm H 60mm Kit		

			
1			
código	695983	referencia	78404300
descripción	canal de expulsión L 85mm An 50mm H 30mm		



1

código	695992	referencia	66057304
descripción	canal de expulsión para máquina de hielo L 110mm An 100mm H 605mm		
Para modelos:	MF41, MF46		



1

código	694099	referencia	66045501
descripción	canal de expulsión para máquina de hielo L 110mm An 75mm H 470mm		



1

código	694098	referencia	66057307
descripción	canal de expulsión para máquina de hielo L 110mm An 100mm H 790mm		
Para modelos:	MF51, MF56, MF56ASR, MF61, MF62, MF66, MF66ASR		



1

código	695987	referencia	66047701
descripción	canal de expulsión para máquina de hielo L 705mm An 205mm H 105mm		
Para modelos:	MC1210, MC45, MC46		



conductos hielo



1

código	694282	referencia	25260473/0 CM 25260472
descripción	conducto hielo para máquina de hielo en cubitos L 210mm An 365mm H 90mm blanco		



1

código	695891	referencia	1121005 KSC 11
descripción	conducto hielo para máquina de hielo L 225mm An 110mm H 210mm juego		



1

código	695179	referencia	25260459 CM25260459
descripción	conducto hielo para máquina de hielo L 530mm An 200mm H 150mm		



1

código	695595	referencia	CM25250099
descripción	conducto hielo para puerta L 345mm An 205mm blanco		



1

código	695665	referencia	25260471/0
descripción	parte interior de puerta para máquina de hielo L 595mm An 210mm H 95mm blanco		
Para modelos:	GP75, GP75W		

mallas antideslizantes



1

código	694145	referencia	650705.00 Z1AC050
descripción	malla antideslizante para máquina de hielo en cubitos L 250mm An 170mm H 25mm		



1

código	695634	referencia	0200333701
descripción	malla antideslizante para máquina de hielo L 415mm An 195mm H 110mm		

palas de hielo



1

código	694197	referencia	65007100
descripción	pala de hielo L 160mm An 80mm H 50mm		
Para modelos:	SD18		



			
1			
código	695244	referencia	650146.00 650923.00
descripción	pala de hielo L 220mm An 114mm H 55mm		

recambios y accesorios

			
1			
código	695839	referencia	65042802
descripción	abrazadera L 8mm agujero ø 2.8mm medidas 7x7mm plástico		
Para modelos:	AF10, AF20, AF30		

			
1			
código	695020	referencia	CM25654016
descripción	arandela para basculación cuba		

sensores

			
1			
código	694715	referencia	IOM101138078
descripción	electrodo de nivel para máquina de hielo en cubitos 1 polos longitud del cable 100mm		

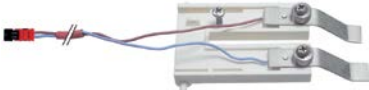
			
1			
código	401764	referencia	1129010S&P CM81453007 CM81453114 CM81453434
descripción	sensor para espesor hielo		
Para modelos:	MV1000, MV12, MV18-21, MV25-32, MV300, MV450, MV50, MV600, MV800		

			
1			
código	696613	referencia	CM81455094
descripción	sensor para máquina de hielo		
Para modelos:	MV456		

			
1			
código	694714	referencia	1100054021
descripción	sensor para nivel de agua 2 polos		

			
1			
código	401793	referencia	1129175S&P 81453590/0 CM81453590
descripción	sensor para nivel de agua 2 polos longitud del cable 60mm		
Para modelos:	MV300, MV450, MV600		

			
1			
código	401837	referencia	81453796 CM81453796
descripción	sensor para nivel de agua 2 polos longitud del cable 85mm		
Para modelos:	MV1000, MV800		

			
1			
código	694555	referencia	CM 25725450
descripción	soporte para sonda L 60mm An 56mm H 18mm chapa de acero tincado espesor 1mm		
Para modelos:	MV1000, MV12, MV18, MV18-21, MV25, MV25-32, MV300, MV450, MV50, MV600, MV800		



sistemas rociadores

SCOTSMAN

brazos rociadores



1	código	695631	referencia	0200252701
	descripción	brazo rociador L 200mm boquillas 6 para máquina de hielo		



1	código	695418	referencia	4114654 65066518
	descripción	brazo rociador L 242mm boquillas 6 para máquina de hielo		
	Para modelos:	SD18		



1	código	695463	referencia	65066501
	descripción	brazo rociador L 242mm boquillas 6 para máquina de hielo		



1	código	695850	referencia	69573900
	descripción	brazo rociador L 367mm boquillas 4 para máquina de hielo		



1	código	695420	referencia	65056520
	descripción	brazo rociador L 385mm boquillas 10 para máquina de hielo		



1	código	695422	referencia	65066504
	descripción	brazo rociador L 385mm boquillas 10 para máquina de hielo		



1	código	695419	referencia	65066502
	descripción	brazo rociador L 385mm boquillas 8 para máquina de hielo		



1	código	695421	referencia	65066505
	descripción	brazo rociador L 385mm boquillas 8 para máquina de hielo		



1	código	695477	referencia	65066523
	descripción	brazo rociador L 420mm boquillas 8 para máquina de hielo		
	Para modelos:	AC105, Barline-50		



1	código	695478	referencia	65066524
	descripción	brazo rociador L 420mm boquillas 8 para máquina de hielo		
	Para modelos:	AC105, Barline-50		



1	código	695065	referencia	3101121S&P 793127.00
	descripción	brazo rociador L 435mm boquillas 4 para máquina de hielo		
	Para modelos:	AC225, AC226, MC1210, MC15, MC16, MC45, MC46, MC8		



1	código	695742	referencia	02548001 0A02548001
	descripción	brazo rociador L 475mm boquillas 10 para máquina de hielo		



1	código	695968	referencia	81453257 CM81453257
	descripción	brazo rociador L 500mm boquillas 3.5 para máquina de hielo		
	Para modelos:	MV50		



1	código	695424	referencia	65066506
	descripción	brazo rociador L 570mm boquillas 12 para máquina de hielo		
	accesorios para	695424		



código	695000	referencia	66055800
descripción	boquilla para máquina de hielo en cubitos		



1	código	695423	referencia	65066508
	descripción	brazo rociador L 570mm boquillas 15 para máquina de hielo		

soportes inyectores



1

código	695635	referencia	79312909
descripción	aerosol L 280mm An 205mm boquillas 6 completo para máquina de hielo		
Para modelos:	AC046, AC056		



1

código	695442	referencia	4114553 79312905
descripción	sistema pulverizador L 273mm An 147mm boquillas 6 completo para máquina de hielo		
Para modelos:	AC045, EC045, ICE-ONE		



1

código	695443	referencia	4114519 79312904
descripción	sistema pulverizador L 273mm An 180mm boquillas 6 completo para máquina de hielo		
Para modelos:	AC055, AC085, ICE-THREE, ICE-TWO		
repuestos para	695443		



código	695063	referencia	3102028S&P 660519.03
descripción	kit tapa con agujeros 3 piezas L 111mm An 30mm H 12mm		



1

código	695444	referencia	4114084S&P 793117.00 79311701 79312901
descripción	sistema pulverizador L 285mm An 210mm boquillas 6 completo para máquina de hielo		
Para modelos:	AC125, AC125B, AC125C, AC175, ACM125, ACM175, Barline-20, Barline-21, Barline-30, Barline-31, Barline-40, Barline-65, Barline-90, Barline-B40, Barline-B65, Barline-B90, Barline-BUL20, CD40		

accesorios



1

código	695062	referencia	3102026S&P 660519.01 660519.02
descripción	boquilla		
Para modelos:	AC125, AC125B, AC125C, AC175, ACM125, ACM175, ACM45, ACM85, Barline-20, Barline-30, Barline-40, Barline-65, Barline-90, Barline-B40, Barline-B65, Barline-B90, Barline-BUL20		

COMPONENTES ESPECÍFICOS SCOTSMAN



1

código	695000	referencia	66055800
descripción	boquilla para máquina de hielo en cubitos		
Para modelos:	AC056, AC086, AC105, AC106, AC126, AC176, Barline-50, Barline-65, Barline-90, Barline-B40, Barline-B65, Barline-B90, Barline-BUL30, Barline-BUL40, Barline-BUL65, Barline-BUL90, SD18		



1

código	695060	referencia	3102037S&P 660155.03
descripción	boquilla para máquina de hielo rosca 3/8" ø 19.5mm H 13mm		
Para modelos:	AC125B, AC125C, AC175, ACM35, ACM55, ACM85		



1

código	694129	referencia	66032000
descripción	cubeta para sistema de pulverización L 190mm An 118mm H 42mm plástico		
Para modelos:	ACM25		



1

código	695061	referencia	3102038S&P 660296.02
descripción	difusor rotacional máquina de hielo en cubitos plástico ø 15mm Lmm Anmm H 3.4mm eje ømm negro		
Para modelos:	AC125B, AC125C, AC175, ACM35, ACM55, ACM85		



1

código	695063	referencia	3102028S&P 660519.03
descripción	kit tapa con agujeros 3 piezas L 111mm An 30mm H 12mm		
Para modelos:	AC045, AC055, AC085, ACM45, EC045, ICE-ONE, ICE-THREE, ICE-TWO		



1

código	695115	referencia	06052900 3102026S&P
descripción	kit tapa con agujeros para máquina de hielo 3 piezas L 110mm An 30mm H 12mm		
Para modelos:	Barline-21, Barline-31		



1

código	695780	referencia	06052901
descripción	kit tapa con agujeros para máquina de hielo 3 piezas L 110mm An 30mm H 12mm gris		
Para modelos:	AC046, AC056, AC086		

			
1			
código	695943	referencia	02986801 0A02986801
descripción	kit tubo		

			
1			
código	695066	referencia	4114099S&P 660475.00
descripción	soporte brazo rociador para máquina de hielo H 150mm eje ø 15mm		
Para modelos:	AC225, AC226, MC1210, MC15, MC16, MC45, MC46, MC8		

			
1			
código	695068	referencia	4114231 66055700
descripción	tapa terminal para máquina de hielo agujero inserto 13x13mm		
Para modelos:	AC056, AC086, AC105, AC106, AC126, AC176, Barline-50, Barline-BUL30, Barline-BUL40, Barline-BUL65, Barline-BUL90, SD18		

puertas

casquillos

			
1			
código	695761	referencia	0200238001
descripción	casquillo para bisagra de puerta batiente ø ext. 9mm int.ø 7mm L 10mm plástico		
Para modelos:	BH550		

			
1			
código	695782	referencia	66028600
descripción	casquillo para puerta ø ext. 12.5mm int.ø 8.2mm L 10.8mm plástico		
Para modelos:	AC045, AC046, AC055, AC056, AC085, AC086, AC105, AC106, AC125, AC125B, AC125C, AC126, AC175, AC176, AC225, AC226, ACM125, ACM175, ACM45, ACM55, ACM85, AF10, AF100, AF20, AF200, AF30, AF80, Barline-40, Barline-50, Barline-65, Barline-90, EC045, ICE-ONE, ICE-THREE, ICE-TWO		

bisagras

			
1			
código	695948	referencia	0200265803
descripción	bisagra pos. de montaje arriba y abajo L 130mm tipo 2842-1009-1110		

			
1			
código	694219	referencia	81461110 CM81461110
descripción	bisagra pos. de montaje centro árbol ø 6.3mm L 42mm		
Para modelos:	B120		

			
1			
código	695648	referencia	19120084 CM19120084
descripción	bisagra de puerta pos. de montaje derecho árbol ø 8mm L 50mm		
Para modelos:	B190, B350, B390, B550		

			
1			
código	695647	referencia	19120085 CM19120085
descripción	bisagra de puerta pos. de montaje izquierdo árbol ø 8mm L 50mm		
Para modelos:	B190, B350, B390, B550		

			
1			
código	695776	referencia	0A03239602
descripción	cojinete giratorio L 40mm An 38mm H 40mm pos. de montaje derecho espesor 3.5mm		
Para modelos:	BH550		

			
1			
código	695781	referencia	0A03239601
descripción	cojinete giratorio L 40mm An 38mm H 40mm pos. de montaje izquierdo espesor 3.5mm		
Para modelos:	BH550		

			
1			
código	695461	referencia	060517.05 06051704
descripción	puerta Kit para máquina de hielo en cubitos An 655mm H 260mm espesor 19mm		

puertas

			
1			
código	696473	referencia	4114166S&P 79200909R
descripción	puerta An 600mm H 260mm espesor 17mm		
Para modelos:	AC125, AC175		

			
1			
código	694126	referencia	03393820 0A03393820
descripción	puerta para contenedor de hielo An 765mm H 390mm espesor 5mm		
Para modelos:	BH550		

			
1			
código	695743	referencia	CM81460184 CM81460326
descripción	puerta para máquina de hielo An 1080mm H 275mm espesor 16mm		
Para modelos:	B350, B550		

			
1			
código	695460	referencia	060517.01 06051700
descripción	puerta con guía puerta para máquina de hielo en cubitos An 485mm H 260mm espesor 19mm		

			
1			
código	695906	referencia	79200901 79200903
descripción	puerta para máquina de hielo An 372mm H 210mm espesor 18mm agujero ø 5mm		

			
1			
código	696654	referencia	81420528
descripción	puerta para máquina de hielo An 680mm H 345mm espesor 20mm		



1



código	695915	referencia	03264801 0A03264801
descripción	puerta para máquina de hielo An 770mm H 290mm espesor 20mm		

1



código	695456	referencia	78205500R
descripción	puerta para máquina de hielo en cubitos An 340mm H 210mm espesor 19mm		

1



código	695458	referencia	78207900R
descripción	puerta para máquina de hielo en cubitos An 345mm H 195mm espesor 14mm		
Para modelos:	Barline-20, Barline-21, Barline-BUL20		

1



código	695462	referencia	4114157 66057200 66057201 79200905
descripción	puerta para máquina de hielo en cubitos An 395mm H 215mm espesor 18mm		
Para modelos:	AC045, AC055, AC085, ACM45, ACM55, ACM85, EC045, ICE-ONE, ICE-THREE, ICE-TWO		

1



código	695459	referencia	4114204 782079.05R 782079.06 78207905
descripción	puerta para máquina de hielo en cubitos An 420mm H 200mm espesor 18mm		
Para modelos:	Barline-30, Barline-31, Barline-BUL30		

1



código	695457	referencia	4114279 781503.00R 792011.01 79201102R
descripción	puerta para máquina de hielo en cubitos An 505mm H 270mm espesor 21mm		
Para modelos:	AC225, AF10, AF100, AF20, AF200, AF30		

1



código	695644	referencia	81460338 CM81460338
descripción	puerta para máquina de hielo en cubitos An 565mm H 295mm espesor 17mm		
Para modelos:	B190		

1





código	694101	referencia	66078601
descripción	puerta para máquina de hielo en cubitos An 600mm H 260mm espesor 24mm		
Para modelos:	AC126, AC176		



			
1			
código	695628	referencia	78128400R
descripción	puerta abatible para máquina de hielo en cubitos An 322mm H 175mm espesor 18mm		

guías de puertas			
			
1			
código	695447	referencia	66052300
descripción	guía de puerta pos. de montaje derecho L 215/240mm An 14mm		
Para modelos:	AC105, AC125, AC125B, AC125C, AC175, ACM125, ACM175, AF80		



			
1			
código	696757	referencia	660784 00
descripción	guía de puerta pos. de montaje derecho L 250mm An 210mm plástico		
Para modelos:	AC086, AC106, AC126, AC176		

			
1			
código	695448	referencia	66052301
descripción	guía de puerta pos. de montaje izquierdo L 215/240mm An 14mm		
Para modelos:	AC105, AC125, AC125B, AC125C, AC175, ACM125, ACM175, AF80		

			
1			
código	696758	referencia	660784 01
descripción	guía de puerta pos. de montaje izquierdo L 250mm An 210mm plástico		
Para modelos:	AC086, AC106, AC126, AC176		

marco de puerta			
			
1			
código	694160	referencia	CM25165550
descripción	marco de puerta An 565mm H 510mm espesor 60mm		
Para modelos:	B193		

			
1			
código	694149	referencia	00102702
descripción	marco de puerta An 675mm H 380mm espesor 24mm completo		
Para modelos:	AC175		

			
1			
código	695912	referencia	78207801R
descripción	marco de puerta An 675mm H 380mm espesor 24mm con guía puerta		
repuestos para	695912		
		código	695447
		referencia	66052300
		descripción	guía de puerta pos. de montaje derecho L 215/240mm An 14mm
		código	695448
		referencia	66052301
		descripción	guía de puerta pos. de montaje izquierdo L 215/240mm An 14mm

			
1			
código	695918	referencia	78207810R
descripción	marco de puerta An 675mm H 380mm espesor 24mm con guía puerta		

árboles de puerta			
			
1			
código	695789	referencia	0200280601
descripción	para árbol de puerta ø 6.1mm L 19mm rosca 3/16" acero inoxidable		
Para modelos:	BH550		



cortinas			
con soporte			
1			
código	695778	referencia	06045400R
descripción	cortina para máquina de hielo An 155mm H 80mm con soporte longitud árbol 166mm árbol ø 6mm		

1			
código	695953	referencia	0200247901
descripción	cortina para máquina de hielo An 210mm H 80mm longitud del soporte 230mm		

1			
código	694185	referencia	0200203801
descripción	cortina para máquina de hielo en cubitos An 215mm H 88mm longitud del soporte 204mm		

sin soporte			
1			
código	699353	referencia	78445706R
descripción	cortina An 295mm H 115mm longitud árbol 305mm árbol ø 7mm		

1			
código	695903	referencia	78416903
descripción	cortina para máquina de hielo An 165mm H 83mm longitud árbol 187mm árbol ø 6mm		
Para modelos:	ACM25		

1			
código	695726	referencia	CM81401600
descripción	cortina para máquina de hielo An 250mm H 70mm longitud árbol 270mm árbol ø 6mm		

1			
código	695429	referencia	4114368S&P 78317100R
descripción	cortina para máquina de hielo An 250mm H 70mm longitud árbol 280mm árbol ø 6mm		
Para modelos:	SD18		

1			
código	695440	referencia	4114555 78425002R
descripción	cortina para máquina de hielo An 283mm H 115mm longitud árbol 305mm árbol ø 6mm		
Para modelos:	Barline-20, Barline-30, Barline-50, Barline-BUL20, Barline-BUL30, CD40		

1			
código	695076	referencia	4114053S&P 784169,09 78416909R
descripción	cortina para máquina de hielo An 284mm H 83mm		
Para modelos:	AC045, AC055, AC085, ACM45, ACM55, ACM85, EC045, ICE-ONE, ICE-THREE, ICE-TWO		

1			
código	695438	referencia	4114554 78445700R
descripción	cortina para máquina de hielo An 293mm H 115mm longitud árbol 350mm árbol ø 6mm		
Para modelos:	Barline-40, Barline-B40, Barline-BUL40		

1			
código	695632	referencia	78416904
descripción	cortina para máquina de hielo An 295mm H 115mm longitud árbol 350mm árbol ø 6mm		

1			
código	695075	referencia	4114089S&P 784169,01 784169.01R
descripción	cortina para máquina de hielo An 305mm H 115mm longitud árbol 323mm árbol ø 6mm		
Para modelos:	ACM35		

1			
código	695439	referencia	4114518 78445704R
descripción	cortina para máquina de hielo An 407mm H 84mm longitud árbol 458mm árbol ø 6mm		
Para modelos:	AC105, Barline-50		



1 			
código	695077	referencia	4114155S&P 784250.03 784250.03R
descripción	cortina para máquina de hielo An 570mm H 115mm longitud árbol 610mm árbol ø 6mm		
Para modelos:	ACM125, ACM175		

1 			
código	695441	referencia	4114645 78445702R
descripción	cortina para máquina de hielo An 574mm H 115mm longitud árbol 610mm árbol ø 6mm		
Para modelos:	Barline-65, Barline-90, Barline-B65, Barline-B90, Barline-BUL65, Barline-BUL90		

1 			
código	695886	referencia	78445703R
descripción	cortina para máquina de hielo An 574mm H 84mm longitud árbol 620mm árbol ø 6mm		
Para modelos:	AC125, AC175, ACM125, ACM175, Barline-65, Barline-90		

1 			
código	696756	referencia	4114669 78445709R
descripción	cortina para máquina de hielo An 580mm H 115mm longitud árbol 595mm árbol ø 6mm		
Para modelos:	AC126, AC176		

accesorios

soportes

1 			
código	695078	referencia	66046900 66046901 66046902
descripción	portacortinas para máquina de hielo		
Para modelos:	AC045, AC055, AC085, ACM45, ACM55, ACM85, EC045, ICE-ONE, ICE-THREE, ICE-TWO		

1 			
código	695079	referencia	66038801
descripción	portacortinas para máquina de hielo An 15mm H 80mm derecho		
Para modelos:	AC086, AC106, AC125B, AC125C, AC126, AC175, AC176, ACM125, ACM175, Barline-20, Barline-21, Barline-30, Barline-31, Barline-40, Barline-50, Barline-65, Barline-90, Barline-B65, Barline-B90, Barline-BUL20, Barline-BUL30, Barline-BUL65, Barline-BUL90, CD40, SD18		

1 			
código	695080	referencia	66038800
descripción	portacortinas para máquina de hielo An 15mm H 80mm izquierdo		
Para modelos:	AC086, AC106, AC125B, AC125C, AC126, AC175, AC176, ACM125, ACM175, Barline-20, Barline-21, Barline-30, Barline-31, Barline-40, Barline-50, Barline-65, Barline-90, Barline-B40, Barline-B65, Barline-B90, Barline-BUL20, Barline-BUL30, Barline-BUL40, Barline-BUL65, Barline-BUL90, CD40, SD18		

lamelas

1 			
código	695081	referencia	660629.00
descripción	lámina para máquina de hielo An 28mm H 71mm ø 6mm		



parte mecánica para cubetas

cubetas

 <p>1</p>			
código	694100	referencia	66071000
descripción	contenedor de agua para máquina de hielo en cubitos L 96mm An 96mm H 130mm entrada 20mm salida 20mm		
Para modelos:	EC045		

 <p>imagen no disponible</p> <p>1</p>			
código	695803	referencia	79311400R
descripción	contenedor de agua para máquina de hielo L 350mm An 225mm H 180mm		

 <p>1</p>			
código	695662	referencia	CM25820125
descripción	contenedor de agua para máquina de hielo L 697mm An 260mm H 148mm blanco		
Para modelos:	MV1000, MV450, MV600, MV800		

 <p>1</p>			
código	695018	referencia	CM81423002
descripción	cubeta completo L 455mm An 180mm H 60mm ICEMATIC		

 <p>1</p>			
código	695014	referencia	814030050 CM81403005
descripción	cubeta completo para máquina de hielo L 180mm An 125mm H 80mm eje L 205mm N20 azul		
Para modelos:	GP20, GP20W		

 <p>1</p>			
código	696414	referencia	814016210 CM81401621
descripción	cubeta completo para máquina de hielo L 180mm An 125mm H 80mm eje L 210mm N25 azul		
Para modelos:	GP20, GP20W		

 <p>1</p>			
código	695015	referencia	814030070 CM81403007
descripción	cubeta completo para máquina de hielo L 225mm An 165mm H 80mm eje L 255mm blanco		
Para modelos:	GP30, GP30W		

 <p>1</p>			
código	695016	referencia	CM81414519 CM81423003
descripción	cubeta completo para máquina de hielo L 275mm An 220mm blanco		

 <p>1</p>			
código	695017	referencia	4114013S&P CM81413001
descripción	cubeta completo para máquina de hielo L 275mm An 220mm H 75mm ICEMATIC blanco		

 <p>1</p>			
código	695019	referencia	CM81442008
descripción	cubeta completo para máquina de hielo L 690mm An 230mm H 65mm ICEMATIC		



1

código	696647	referencia	CM25820130
descripción	cubeta para máquina de hielo L 680mm An 240mm H 150mm blanco		
Para modelos:	MV456		



1

código	695911	referencia	66048700
descripción	cubeta para sistema de pulverización H 140mm ø 495mm		
Para modelos:	AC225, AC226, MC1210, MC15, MC16, MC45, MC46, MC8		

recambios y accesorios



1

código	695479	referencia	CM81413043
descripción	arandela para basculación cuba ø 100mm árbol ø 7mm		



1

código	695670	referencia	CM252600000
descripción	arandela para basculación cuba ø 100mm soporte de eje ø 7mm		



1

código	695004	referencia	CM25030006
descripción	árbol para máquina de hielo ø 6mm L 165mm inox		



1

código	695005	referencia	CM25030007
descripción	árbol para máquina de hielo ø 6mm L 206mm		



1

código	695006	referencia	CM25030010 CM25030011
descripción	árbol para máquina de hielo ø 6mm L 315mm inox		



1

código	695681	referencia	CM25110914
descripción	casquillo para árbol ø ext. 10mm int.ø 6.2mm L 20mm plástico ICEMATIC		



1

código	695023	referencia	CM25325953
descripción	guía para palanca L 30mm An 12mm H 15mm		



1

código	695025	referencia	CM25440110 CM81403011
descripción	palanca para cubeta L 143mm An 29mm H 37mm soporte de eje ø 10mm plástico ICEMATIC		



1

código	695026	referencia	CM25560256
descripción	pasador para palanca L 38mm ø 4.5mm metal		



1

código	696527	referencia	CM25545520 CM25545521
descripción	remo ø 145mm soporte de eje ø 6mm longitud árbolmm 1		



1

código	695021	referencia	CM25474600
descripción	resorte de torsión ø 20.8mm L1 23.2mm L2 37mm espesor de hilo 2.3mm para máquina de hielo		



1

código	695022	referencia	CM25474602
descripción	resorte de torsión ø 21.2mm L1 26mm L2 37mm espesor de hilo 2.6mm para máquina de hielo		





1

código	695024	referencia	CM25110911
descripción	rollo para basculación cuba ø 26.7mm soporte de eje ø 8.1mm		



			
1			
código	695009	referencia	CM25726115
descripción	soporte paleta L 50mm An 17mm H 23mm soporte de eje ø 6.5mm distancia de sujeción 30mm		

			
1			
código	695646	referencia	25726279 25726478/0
descripción	soporte para contrapuerta L 44mm An 20mm H 18mm soporte de eje ø 6.3mm distancia de sujeción 30mm		
Para modelos:	GP20, GP20W, GP30, GP30W, GP75, GP75W, GP90, GP90W		

			
1			
código	695415	referencia	CM25726122
descripción	soporte para cubeta pos. de montaje derecho ICEMATIC		

			
1			
código	695651	referencia	CM25525419
descripción	soporte para impulsador L 34mm An 15mm H 60mm		

			
1			
código	695035	referencia	CM25725433 CM25725439
descripción	soporte de eje para motor a palas L 30mm An 17mm H 60mm soporte de eje ø 4mm distancia de sujeción 17mm		

ruedas dentadas

			
1			
código	691787	referencia	65115700
descripción	rueda dentada ø 27/101mm soporte de eje ø 13mm dientes 15/94		
Para modelos:	MF41, MF46, MF51, MF56, MF56ASR, MF61, MF62, MF66, MF66ASR		

sistema de aspiración

filtro de aspiración

			
1			
código	695416	referencia	Z1AC012
descripción	filtro aspiración ø 36mm H 25mm		

técnica de propulsión

ruedas dentadas

			
1			
código	695582	referencia	65115600
descripción	rueda dentada dientes 65 ancho de diente 14.5mm ø ext. 74mm H 72mm árbol ø 12.7mm		
Para modelos:	MF41, MF46, MF51, MF56, MF56ASR, MF61, MF62, MF66, MF66ASR		

			
1			
código	694780	referencia	651158.00
descripción	rueda dentada ø 135mm eje ø 25mm An 19mm dientes 83		
Para modelos:	MF41, MF51, MF56, MF56ASR, MF61, MF62, MF66, MF66ASR		

			
1			
código	695586	referencia	65116000
descripción	rueda dentada ø 21.3mm dientes 18-41 D1 ø 58mm eje ø 8 eje L 55mm		
Para modelos:	AF10, AF100, AF20, AF200, AF30, AF80, MF20, MF22, MF26, MF30, MF36		

			
1			
código	697919	referencia	65116100
descripción	rueda dentada ø 62/20mm eje ø 9.5mm dientes 56/10 para mecanismo		
Para modelos:	AF10, AF100, AF20, AF200, AF30, AF80, MF20, MF22, MF26, MF30, MF36		



juntas

juntas planas



1

código	510215	referencia	4114312S&P 64006000
descripción	junta int.ø 50mm espesor 3.5mm fibra dist. del agujero 71mm 3 orificios		
Para modelos:	AF10, AF100, AF20, AF200, AF30, AF80, MF20, MF22, MF26, MF30, MF36		



1

código	695880	referencia	64007609
descripción	junta plana fibra ø ext. 38mm int.ø 27mm espesor 1mm UE 1 pzs		
Para modelos:	MAR1, MAR10, MAR125, MAR2, MAR20, MAR3, MAR30, MAR5		



1

código	695623	referencia	1300070400 13-0704-00 64000000
descripción	junta plana ø ext. 138mm int.ø 78mm espesor 1mm corcho		
Para modelos:	AF730, AN760, AutoSentry-Double-System-RL, Double-System-RL, FM1200, FM1200R, FM1202, FM1202R, FM1202RL, FM1202RL-C, FM1500, FM1500R, FM2400, FM2400R, FM2400RH, FM2402, FM2402R, FM2402RH, FM800, FM800R, FME1200, FME1200R, FME1202RL, FME1204, FME1204R, FME1204RL, FME1500, FME1500R, FME1500RL, FME1504, FME1504R, FME1504RL, FME2400, FME2400R, FME2400RH, FME2404, FME2404R, FME504AS-1A, FME504WS-1A, FME800AE-1A, FME800AE-6A, FME800AE-6B, FME800R, FME800WE-1A, FME800WE-6A, FME800WE-6B, FME804AS-1A, FME804AS-1B, FME804AS-6A, FME804AS-6B...(Otros modelos se puede ver en la tienda web)		



1

código	695836	referencia	0300150500 64003000
descripción	junta plana ø ext. 87mm int.ø 48mm espesor 1mm corcho		
Para modelos:	AF10, AF20, AF30		

juntas de árbol



1

código	696651	referencia	02001607 0200160701 02160701 CF02001607 CF02160701
descripción	cojinete de árbol para máquina de hielo ø ext. 33.5mm int.ø 25.7mm H 3mm para cojinete de árbol metal		
Para modelos:	MF41, MF46, MF51, MF56, MF56ASR, MF61, MF62, MF66, MF66ASR, MF6C, MF900RC		



1

código	695785	referencia	64001000
descripción	junta goma ø ext. 75mm int.ø 22mm espesor 1mm UE 1 pzs		



1

código	695784	referencia	64003400
descripción	junta goma ø ext. 95mm int.ø 23mm espesor 3.2mm UE 1 pzs		



1

código	694191	referencia	1300070902 13070902
descripción	junta para evaporador ø ext. 48mm int.ø 23mm H 7mm goma		
Para modelos:	AF730, AN760, HQD550, HQD650, HQD750, MF41, MF46, MF51, MF56, MF56ASR, MF61, MF62, MF66, MF66ASR, MF6C, MF900RC, MH750, PO760		



1

código	695589	referencia	02001300.21 64004000
descripción	junta de árbol ø ext. 48mm int.ø 25mm H 22mm apto para tornillo sinfin		
Para modelos:	AF10, AF100, AF20, AF200, AF30, AF80, MF20, MF22, MF26, MF30, MF36		



<p>1</p>			
código	695936	referencia	0200092901 0200092902 0200092923
descripción	junta de árbol ø ext. 77mm int.ø 44mm H 31mm apto para tornillo sinfin		

<p>1</p>			
código	695428	referencia	4114228S&P 65040200
descripción	junta de árbol para esparrago ø ext. 45mm int.ø 30mm		
Para modelos:	MF41, MF46, MF51, MF56, MF56ASR, MF61, MF62, MF66, MF66ASR		

<p>1</p>			
código	695656	referencia	65052500
descripción	junta de árbol para esparrago ø ext. 65.5mm int.ø 48mm H 83mm		
Para modelos:	MAR1, MAR10, MAR2, MAR20, MAR3, MAR30, MAR5, MF102, MF82, MF83		

<p>1</p>			
código	694187	referencia	00102803
descripción	junta de árbol para esparrago ø ext. 65.5mm int.ø 48mm H 83mm juego		
Para modelos:	MAR1, MAR10, MAR2, MAR20, MAR3, MAR30, MAR5		

<p>1</p>			
código	695774	referencia	64001600
descripción	junta de árbol para motor int.ø 9mm ø ext. 45mm espesor 8mm		

<p>otros</p> <p>1</p>			
código	695870	referencia	1300068700
descripción	junta int.ø 66mm ø 88mm espesor 8mm goma		

<p>1</p>			
código	695869	referencia	1300067900
descripción	junta L 80mm An 38mm espesor 3.8mm silicona		

<p>1</p>			
código	694111	referencia	64013800
descripción	junta para contenedor L 98mm An 98mm espesor 2mm silicona		
Para modelos:	EC045		

<p>1</p>			
código	695961	referencia	0200143700
descripción	junta para máquina de hielo L 94mm An 45mm espesor 4mm silicona		

<p>1</p>			
código	697879	referencia	0A026103.01 13000617.38
descripción	junta tórica NBR espesor 2.62mm int.ø 219mm UE 1 pzs		
Para modelos:	MF41, MF46, MF51, MF56, MF56ASR, MF61, MF62, MF66, MF66ASR		

cajas y paneles frontales

paneles



1			
código	692219	referencia	4114711 81453613 CM25725525 CM81453613
descripción	revestimiento An 180mm H 46mm P 48mm		
Para modelos:	MV1000, MV300, MV450, MV600, MV800		

carcasas



1			
código	696646	referencia	25161143 CM25161143 CM25161164/0
descripción	caja para distribución L 245mm An 245mm H 140mm		
Para modelos:	MV1000, MV450, MV600, MV800		

aislamientos



1			
código	695913	referencia	0200292001
descripción	aislamiento		



1			
código	694112	referencia	06055101 66050902 66050903
descripción	aislamiento para canal de expulsión L 190mm An 200mm H 175mm		
Para modelos:	MF41, MF46, MF51, MF56, MF56ASR, MF61, MF62, MF66, MF66ASR		



1			
código	695941	referencia	06055105
descripción	aislamiento para cilindro de congelación		
Para modelos:	MF41, MF46, MF66, MF66ASR		



1

código	694109	referencia	06055102 4114525S&P
descripción	aislamiento para cilindro de congelación H 110mm ø 124mm		



1

código	695988	referencia	06055103
descripción	aislamiento para cilindro de congelación H 160mm ø 117mm		
Para modelos:	AF100, AF200, AF80, MF20, MF22, MF26		



1

código	695989	referencia	06055104 66037600 66037601
descripción	aislamiento para máquina de hielo H 230mm ø 117mm		
Para modelos:	AF30, MF30, MF36		

tubos para refrigeración



1

código	694137	referencia	78429401R
descripción	tubo para refrigeración con colector L 1000mm		



1

código	694130	referencia	78446901
descripción	tubo para refrigeración con colector L 1150mm		
Para modelos:	AF10, AF100		



1

código	694134	referencia	78444403
descripción	tubo para refrigeración con colector L 1300mm		
Para modelos:	AC055, ICE-TWO		



1

código	694133	referencia	78420102R
descripción	tubo para refrigeración con colector L 1500mm		

tapa



1

código	696610	referencia	CM81453131
descripción	cubeta para máquina de hielo An 500mm H 70mm L 540mm para evaporador		
Para modelos:	MV25-32, MV50		



1

código	696644	referencia	CM81453466
descripción	tapa para máquina de hielo An 365mm L 410mm para evaporador		
Para modelos:	MV12, MV300		

repuestos para	696644	código	347059	referencia	—
	imán L 40mm H 8mm An 13.2mm dist. del agujero 30mm				



1

código	696641	referencia	CM81453692
descripción	tapa para máquina de hielo An 365mm L 420mm para evaporador		

repuestos para	696641	código	347059	referencia	—
	imán L 40mm H 8mm An 13.2mm dist. del agujero 30mm				



1

código	696645	referencia	CM25550400
descripción	tapa para máquina de hielo An 473mm L 420mm para evaporador		



1

código	696392	referencia	CM81453130
descripción	tapa para máquina de hielo An 493mm L 423mm para evaporador		



1

código	696642	referencia	CM25820126
descripción	tapa para máquina de hielo An 493mm L 423mm para evaporador		

accesorios para	696642	código	347059	referencia	—
	imán L 40mm H 8mm An 13.2mm dist. del agujero 30mm				



1

código	695698	referencia	CM81453262
descripción	tapa para máquina de hielo An 495mm H 560mm espesor 38mm		
Para modelos:	MV50		



1

código	696643	referencia	CM81453651
descripción	tapa para máquina de hielo An 525mm L 640mm para evaporador		
Para modelos:	MV1000		
repuestos para	696643		
	código	347059	referencia —
	imán L 40mm H 8mm An 13.2mm dist. del agujero 30mm		

partes mecánicas para evaporadores

tornillos sin fin



1

código	695626	referencia	72405208
descripción	tornillo sin fin ø 46mm L 206mm		
Para modelos:	AF80		



1

código	691788	referencia	72405207
descripción	tornillo sin fin ø 46mm L 260mm		
Para modelos:	AF10, AF100, AF20, AF200, MF20, MF22, MF26		



1

código	691789	referencia	72405206
descripción	tornillo sin fin ø 46mm L 330mm		
Para modelos:	AF30, MF30, MF36		



1

código	691790	referencia	65072700
descripción	tornillo sin fin ø 46mm L 350mm		



1

código	695969	referencia	02948001 0A02948001
descripción	tornillo sin fin ø 47mm L 245mm		



1

código	694162	referencia	0200061700
descripción	tornillo sin fin \varnothing 75mm L 340mm		

soportes

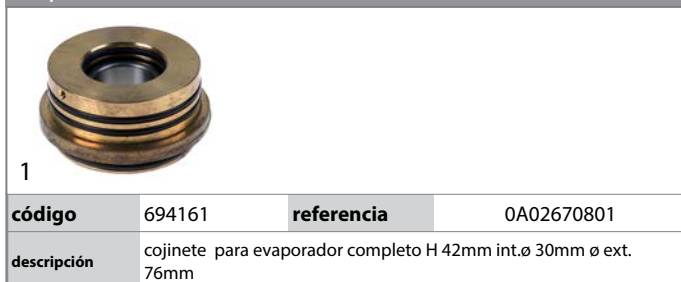

1

código	694161	referencia	0A02670801
descripción	cojinete para evaporador completo H 42mm int. \varnothing 30mm \varnothing ext. 76mm		



1

código	694105	referencia	4114679 76400700
descripción	soporte para evaporador H 90mm aluminio int. \varnothing 59mm \varnothing ext. 140mm		
Para modelos:	MF41, MF46, MF51, MF56, MF56ASR, MF61, MF62, MF66, MF66ASR		

poleas para correas trapezoidales



1

código	695897	referencia	73459741
descripción	polea para correa trapezoidal simple \varnothing arandela 106mm soporte de eje \varnothing 18mm profundidad de ranura 14mm ancho arandela 20mm ancho de ranura 4mm anchura total 46mm aluminio		



1

código	695898	referencia	73459739
descripción	polea para correa trapezoidal simple \varnothing arandela 133mm soporte de eje \varnothing 16mm profundidad de ranura 14mm ancho arandela 20mm ancho de ranura 4mm anchura total 41mm aluminio		
Para modelos:	MAR30		

otros

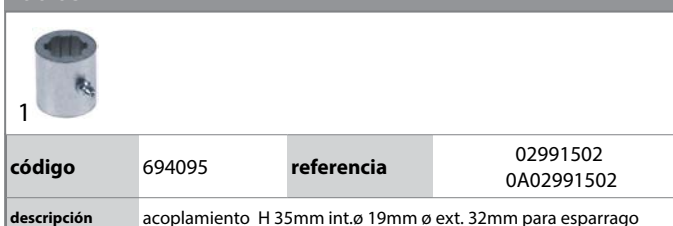

1

código	694095	referencia	02991502 0A02991502
descripción	acoplamiento H 35mm int. \varnothing 19mm \varnothing ext. 32mm para esparrago		

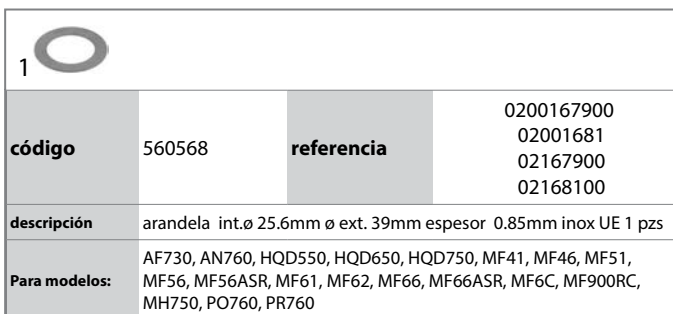

1

código	560568	referencia	0200167900 02001681 02167900 02168100
descripción	arandela int. \varnothing 25.6mm \varnothing ext. 39mm espesor 0.85mm inox UE 1 pzs		
Para modelos:	AF730, AN760, HQD550, HQD650, HQD750, MF41, MF46, MF51, MF56, MF56ASR, MF61, MF62, MF66, MF66ASR, MF6C, MF900RC, MH750, PO760, PR760		





1

código	695945	referencia	0200291601 02-2916-01
descripción	cubierta H 30mm int. \varnothing 83mm \varnothing ext. 128mm para evaporador		
Para modelos:	AutoSentry-Double-System-RL, Double-System-RL, FM1200, FM1200R, FM1202, FM1202R, FM1202RL, FM1202RL-C, FM1500, FM1500R, FM2400, FM2400R, FM2400RH, FM2402, FM2402R, FM2402RH, FM800, FM800R, FME1200, FME1200R, FME1202RL, FME1204, FME1204R, FME1204RL, FME1500, FME1500R, FME1500RL, FME1504, FME1504R, FME1504RL, FME2400, FME2400R, FME2400RH, FME2404, FME2404R, FME504AS-1A, FME504WS-1A, FME800AE-1A, FME800AE-6A, FME800AE-6B, FME800R, FME800WE-1A, FME800WE-6A, FME800WE-6B, FME804AS-1A, FME804AS-1B, FME804AS-6A, FME804AS-6B, FME804R, FME804RL...(Otros modelos se puede ver en la tienda web)		



			
1			
código	694220	referencia	72148200
descripción	placa de presión L 265mm An 220mm H 22mm		
Para modelos:	MF82		

			
1			
código	694192	referencia	1300089802 13089802
descripción	protección L 66mm An 40mm H 12mm int.ø 10mm para evaporador goma		
Para modelos:	CME256, CME506, CME656, CME806		

			
1			
código	694096	referencia	66048900
descripción	soporte L 46mm An 13mm H 21mm int.ø 8mm para evaporador		
Para modelos:	AC225, AC226, MC15, MC16, MC45, MC46, MC8		

			
1			
código	694598	referencia	65051505 CF78447601
descripción	soporte de imán con imán H 37mm ø ext. 42mm plástico		
Para modelos:	AF10, AF20, AF30, MF30, MF41, MF51, MF61		

			
1			
código	694135	referencia	72503501
descripción	sporte L 230mm An 25mm H 55mm para evaporador		
Para modelos:	MF41, MF46, MF51, MF56, MF56ASR, MF61, MF62, MF66, MF66ASR		

			
1			
código	694136	referencia	72410101
descripción	tapa L 79mm An 52mm H 40mm para microinterruptor		

motorreductores

mecanismo

			
1			
código	695607	referencia	0A03123001 4114213
descripción	caja para mecanismo		
Para modelos:	MF41, MF46, MF51, MF56, MF56ASR, MF61, MF62, MF66, MF66ASR		

motores

			
1			
código	500745	referencia	06027303
descripción			

			
1			
código	500778	referencia	1200064306
descripción	motor 180W 110/230V 50Hz fases 1 árbol ø 12.8mm 1425rev/min tipo SKC37MG180FT GENERAL ELECTRIC 0.18kW		

			
1			
código	500744	referencia	62048001
descripción	motor 550W 230/400V 50Hz fases 3 árbol ø 19mm brida ø 120mm 1400rev/min tipo BN80A4 ø 150mm H 200mm L 240mm BONFIGLIOLI 0.55kW		
Para modelos:	MF82, MF83		



		
1		
código	500767	referencia 62038302
descripción	motor 550W 230/400V 60Hz fases 3 árbol ø 19mm 900rev/min tipo H80B6 ø 155mm H 160mm L 240mm medida de sujeción 100x125mm COEL 0.55kW	

agitadores

		
1		
código	695427	referencia 65072500
descripción	agitador ø 86mm H 51mm int.ø 11.6mm	

tubos flexibles

tubos formados

recto

otros

		
1		
código	695787	referencia 61015904
descripción	tubo flexible recto L 750mm plástico espesor 2mm ø int. 14mm ø int. 2 18mm	
Para modelos:	AC225, ICE-ONE, ICE-THREE, ICE-TWO, MF82, MF83	

forma L

		
1		
código	694131	referencia 61014700
descripción	tubo formado L-Form int.ø 11mm ø ext. 15mm L 200mm An 65mm	
Para modelos:	Barline-40, Barline-B40, Barline-BUL40	

		
1		
código	694132	referencia 61014810
descripción	tubo formado L-Form int.ø 19mm ø ext. 23mm L 320mm An 90mm	
Para modelos:	AC045, AC055, AC056, AC085, AC086, AC105, AC106, AC125, AC126, AC175, AC176, AC226, ACM45, ACM55, ACM85, Barline-20, Barline-30, Barline-40, Barline-50, Barline-65, Barline-90, Barline-B40, Barline-B65, Barline-B90, Barline-BUL20, Barline-BUL30, Barline-BUL40, Barline-BUL65, Barline-BUL90, EC045, ICE-ONE, ICE-THREE, ICE-TWO, MAR125, MC1210, MC15, MC16, MC45, MC46, MC8, RB400, SD18	

		
1		
código	695089	referencia Z1CE016
descripción	tubo formado L-Form para máquina de hielo en cubitos int.ø 12,5/22mm ø ext. 18,5/27mm L 300mm An 30mm	

		
1		
código	695092	referencia Z1CE016
descripción	tubo formado L-Form para máquina de hielo en cubitos int.ø 13/21mm ø ext. 18/27mm L 345mm An 80mm	

		
1		
código	695091	referencia 610189.01
descripción	tubo formado L-Form para máquina de hielo en cubitos int.ø 24mm ø ext. 27mm L 130mm An 105mm	

		
1		
código	695809	referencia 61016600 61016601
descripción	tubo formado L-Form para máquina de hielo int.ø 11mm ø ext. 15mm L 290mm An 130mm	
Para modelos:	ACM55, ACM85, ICE-ONE, ICE-THREE, ICE-TWO	

forma S

		
1		
código	695810	referencia 61016400
descripción	tubo formado forma S doble int.ø 11mm ø ext. 15mm L 300mm An 50mm	
Para modelos:	ACM35	

		
1		
código	695090	referencia Z1D038
descripción	tubo formado forma S para máquina de hielo en cubitos int.ø 16/20mm ø ext. 21/25mm L 110mm An 75mm	

		
1		
código	695094	referencia 3450075
descripción	tubo formado forma S para máquina de hielo en cubitos int.ø 16/20mm ø ext. 21/26mm L 130mm An 70mm	



			
1			
código	694093	referencia	4114693 61016700
descripción	tubo formado forma S para máquina de hielo en cubitos int.ø 18mm ø ext. 22mm L 300mm An 100mm		
Para modelos:	MC15, MC16, MC45, MC46		

			
1			
código	695093	referencia	Z1ID037
descripción	tubo formado forma S para máquina de hielo en cubitos int.ø 20/23mm ø ext. 26/29mm L 115mm An 90mm		

forma U			
grupo 1			
			
1			
código	695805	referencia	61016300
descripción	tubo formado forma U int.ø 11mm ø ext. 15mm L 105mm An 65mm		
Para modelos:	ACM35		

otros			
			
1			
código	695813	referencia	61013900
descripción	tubo formado int.ø 11mm ø ext. 15mm L 500mm An 110mm		
Para modelos:	ACM25		

			
1			
código	694104	referencia	4114694 61018800
descripción	tubo formado int.ø 16mm ø ext. 20mm L 440mm An 210mm PVC		
Para modelos:	AC225, AC226, MC1210, MC15, MC16, MC45, MC46, MC8		

empalmes de tubo

con rosca

			
1			
código	695051	referencia	Z1AC028
descripción	empalme de tubo		

			
1			
código	695045	referencia	3118015S&P 660224.00
descripción	empalme de tubo 3 vías int.ø 15mm ø ext. 21mm L 91mm		
Para modelos:	AC045, AC046, AC055, AC056, AC085, AC086, AC105, AC106, AC125, AC125B, AC125C, AC126, AC175, AC176, AC225, AC226, ACM125, ACM175, ACM35, ACM45, ACM55, ACM85, AF10, AF100, AF20, AF200, AF30, AF80, Barline-20, Barline-21, Barline-30, Barline-31, Barline-40, Barline-50, Barline-65, Barline-90, Barline-B40, Barline-B65, Barline-B90, Barline-BUL20, Barline-BUL30, Barline-BUL40, Barline-BUL65, Barline-BUL90, EC045, ICE-ONE, ICE-THREE, ICE-TWO, MAR1, MAR10... (Otros modelos se puede ver en la tienda web)		

			
1			
código	695048	referencia	3124069S&P Z1ID025
descripción	empalme de tubo para máquina de hielo en cubitos		

			
1			
código	695049	referencia	Z1AD011
descripción	empalme de tubo para máquina de hielo en cubitos		





			
1			
código	695096	referencia	Z1AC030
descripción	empalme de tubo para máquina de hielo en cubitos		

			
1			
código	695053	referencia	66029100
descripción	empalme de tubo para máquina de hielo en cubitos recto boquilla ø 11.5mm longitud boquilla 16mm EC 27 rosca L 15mm plástico G1: 3/4" G2: 5/8" UNF (3/8" SAE)		
Para modelos:	AC045, AC055, AC085, AC105, AC106, AC125, AC125B, AC125C, AC126, AC175, AC176, AC225, AC226, ACM125, ACM175, ACM35, ACM45, ACM55, ACM85, AF20, AF30, Barline-20, Barline-30, Barline-40, Barline-50, EC045, ICE-ONE, ICE-THREE, ICE-TWO, MC45, MC8		

			
1			
código	695875	referencia	66053400
descripción	empalme de tubo recto plástico D1 ø 12.5mm D2 ø 14mm		
Para modelos:	AC125, AC125B, AC125C, AC175, ACM125, ACM175, ACM45, ACM55, ACM85		

			
1			
código	361796	referencia	73317400
descripción	empalme de tubo rosca 3/4" M boquilla ø 13.5mm int.ø 10mm longitud boquilla 20mm EC 27 rosca L 22mm		
Para modelos:	AF20, AF200, AF30, AF80, MC1210, MC15, MC16, MC45, MC46, MF20, MF22, MF26, MF30, MF36, MF41, MF46, MF51, MF56, MF61, MF66, MF66ASR		

			
1			
código	695845	referencia	65062300
descripción	empalme de tubo rosca 3/8" tubo ø 13.5mm curvado 90° plástico		
Para modelos:	MC15, MC45		

			
1			
código	695760	referencia	0002521360 CS0002521360
descripción	empalme de tubo rosca 3/8" tubo ø 8mm recto plástico		

			
1			
código	695846	referencia	66021301
descripción	empalme de tubo rosca 7/8" UNF para tubo DI 20mm curvado 90° plástico		
Para modelos:	AC225, AC226, ACM35, AF20, AF30, MAR125, MC8		

			
1			
código	695095	referencia	Z1AC029
descripción	empalme de tubo rosca M22 tubo ø 16mm plástico para máquina de hielo en cubitos int.ø 16mm ø ext. 22mm L 45mm		

			
1			
código	695791	referencia	0200212101
descripción	empalme de tubo T plástico ø 19mm izquierdo		

sin rosca			
			
1			
código	695050	referencia	256908060 CM25690806
descripción	empalme de tubo recto plástico L 70mm ø 21mm		
Para modelos:	CD40, GP20, GP20W, GP30, GP40, GP40W, GP50, GP50W, GP75, GP75W, GP90, GP90W, MV12, MV18-21, MV25-32, MV50		

otros			
			
1			
código	694177	referencia	0200397801
descripción	casquillo tubo ø 14mm		

distribuidores de agua			
			
1			
código	694170	referencia	61019402
descripción	tubo flexible para pieza T para máquina de hielo L 137mm		



código	694168	referencia	61019404
descripción	tubo flexible pieza T L 420mm		



código	694176	referencia	61017601
descripción	tubo flexible pieza T L 470mm		
Para modelos:	AC125, AC125B, AC125C, AC175, ACM125, ACM175, Barline-65, Barline-90, Barline-B65, Barline-B90, Barline-BUL65, Barline-BUL90		



código	694171	referencia	61019401
descripción	tubo flexible pieza T para máquina de hielo L 580mm		

otros



código	520447	referencia	73320400
descripción	boquilla doble rosca 3/8" - 3/4" L1 24mm L2 12mm		
Para modelos:	AC125, AC125B, AC125C, AC126, AC175, AC176, AC225, AC226, ACM125, ACM175, ACM55, ACM85, AF20, AF200, AF30, AF80, MC1210, MC15, MC16, MC45, MC46, MC8, MF20, MF22, MF26, MF30, MF36, MF41, MF46, MF51, MF56, MF61, MF66		

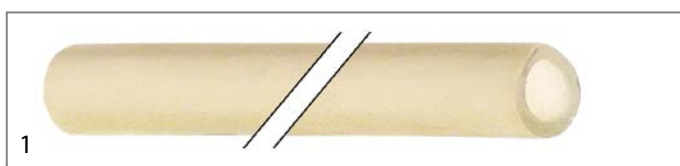

código	530769	referencia	CM25790880
descripción	tubo de silicona para máquina de hielo en cubitos int.ø 14mm ø ext. 20mm L 650mm		
Para modelos:	MV25, MV25-32		



código	530050	referencia	28190001
descripción	tubo flexible int.ø 10mm ø ext. 16mm		
Para modelos:	AC045, AC046, AC055, AC056, AC085, AC086, AC105, AC106, AC125, AC125B, AC125C, AC126, AC175, AC176, ACM125, ACM175, ACM35, ACM45, ACM55, ACM85, Barline-20, Barline-21, Barline-30, Barline-31, Barline-40, Barline-50, Barline-65, Barline-90, Barline-B40, Barline-B65, Barline-B90, Barline-BUL20, Barline-BUL30, Barline-BUL40, Barline-BUL65, Barline-BUL90, EC045, ICE-ONE, ICE-THREE, ICE-TWO, MC1210, SD18		



código	695999	referencia	03091801 0A03091801
descripción	tubo flexible de PVC int.ø 13mm ø ext. 19mm L 11mm grosor de la pared 3mm transparente		

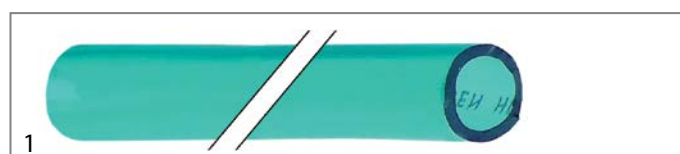

código	520416	referencia	CS0002801318
descripción	tubo flexible de PVC int.ø 18mm ø ext. 24mm grosor de la pared 3mm UE al metro		
Para modelos:	SW12		

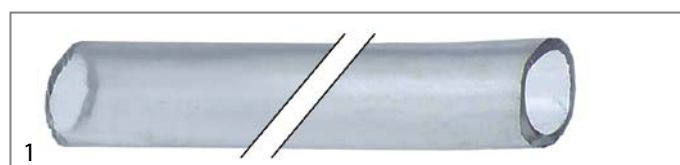

código	520448	referencia	00028013 CS00028013
descripción	tubo flexible de PVC int.ø 18mm ø ext. 24mm L 800mm grosor de la pared 3mm transparente		



código	695896	referencia	74300000
descripción	tubo flexible de PVC int.ø 18mm ø ext. 24mm L 88mm grosor de la pared 3mm		



código	530046	referencia	61017300
descripción	tubo formado para máquina de hielo en cubitos L 23mm		
Para modelos:	AC045, AC055, AC085, AC125, AC125B, AC125C, AC175, ACM125, ACM175, ACM45, ACM55, ACM85, EC045, MC1210		



1

código	530028	referencia	61020900
descripción	tubo formado para máquina de hielo en cubitos ø ext. 12mm L 60mm		

flotadores

tapas de recipientes



1

código	695038	referencia	4114148S&P 660363.00
descripción	tapa L 150mm An 102mm para recipiente de flotador		
Para modelos:	AF10, AF100, AF20, AF200, AF30, AF80, MAR1, MAR10, MAR5, MF20, MF22, MF26, MF30, MF36, MF41, MF46, MF51, MF56, MF56ASR, MF61, MF62, MF66, MF66ASR		



1

código	694110	referencia	66071100
descripción	tapa L 98mm An 98mm espesor 3mm para recipiente de flotador		

contenedores flotantes



1

código	695071	referencia	0200221701
descripción	recipiente de flotador para máquina de hielo en cubitos L 150mm An 65mm H 100mm plástico		



1

código	694163	referencia	03292920 0A03292920
descripción	recipiente de flotador para máquina de hielo L 145mm An 95mm H 130mm completo plástico		



1

código	695037	referencia	793126.01 793126.03
descripción	recipiente de flotador para máquina de hielo plástico		
Para modelos:	AF10, AF100, AF20, AF200, AF30, AF80, MF20, MF22, MF26, MF30, MF36, MF41, MF46, MF51, MF56, MF56ASR, MF61, MF62, MF66, MF66ASR		

otros



1

código	695998	referencia	0200338301 0200338321
descripción	barra for float switch ø 15mm L 180mm tamaño orificio 3,5x30mm plástico		



1

código	695649	referencia	0200338302
descripción	barra for float switch ø 15mm L 180mm tamaño orificio 3,5x51mm plástico		



1

código	695997	referencia	78315300R
descripción	boquilla para fabricante de hielo en escamas L 168mm ø 8mm para flotador		
Para modelos:	AF100, AF200, MF20, MF22, MF26, MF30, MF36, MF41, MF46, MF51, MF56, MF56ASR, MF61, MF62, MF66, MF66ASR		



			
código	695995	referencia	0200326603
descripción	varilla de presión para flotador L 14mm con junta acero inoxidable		

otros

			
código	695940	referencia	0300152601
descripción	abrazadera L 12mm An 6mm H 4mm		

			
código	694224	referencia	66038600
descripción	abrazadera para sonda L 20mm An 9mm H 14mm int.ø 7mm		
Para modelos:	AC056, AC086, ACM25, ACM55, Barline-21, Barline-31, ICE-ONE, ICE-THREE, ICE-TWO		

			
código	695744	referencia	06055100 4114366S&P 65088700 66013200 66013300
descripción	aislamiento L 150mm An 100mm H 140mm int.ø 55mm		
Para modelos:	AF10, AF100, AF20, AF200, AF30, AF80, MF20, MF22, MF26, MF30, MF36		

			
código	695417	referencia	Z11D043
descripción	aislamiento para bomba		

			
código	695851	referencia	1300021700
descripción	amortiguador para máquina de hielo goma ø 100mm espesor 17.5mm		

			
código	695856	referencia	65041300
descripción	anillo int.ø 26mm H 4.7mm D1 ø 29mm D2 ø 34mm para muelle		
Para modelos:	AF10, AF20, AF30		

			
código	695832	referencia	61000300
descripción	anillo cortante para máquina de hielo L 6.5mm int.ø 6.2mm ø ext. 8.5mm		

			
código	695934	referencia	00769900 0A00769900
descripción	arandela int.ø 11.5mm ø ext. 24mm latón		

			
código	695864	referencia	40003100
descripción	arandela para máquina de hielo en cubitos int.ø 16mm ø ext. 31mm fibra espesor 1mm		
Para modelos:	AC045, AC055, AC085, AC105, AC106, AC125, AC125B, AC125C, AC126, AC175, AC176, AC225, AC226, ACM125, ACM175, ACM35, ACM45, ACM55, ACM85, AF10, AF100, AF20, AF200, AF30, AF80, Barline-20, Barline-30, Barline-40, Barline-50, EC045, ICE-ONE, ICE-THREE, ICE-TWO, MAR1, MAR10, MAR125, MAR2, MAR20, MAR3, MAR30, MAR5, MC8, MF20, MF22, MF26, MF30, MF36, MF41, MF46, MF51... (Otros modelos se puede ver en la tienda web)		

			
código	695861	referencia	40005200
descripción	arandela para máquina de hielo en cubitos int.ø 27mm ø ext. 37mm fibra espesor 1mm		
Para modelos:	AC125, AC125B, AC125C, AC126, AC175, AC176, ACM125, ACM175, AF20, AF30, AF80, Barline-65, Barline-90, Barline-B65, Barline-B90, Barline-BUL65, Barline-BUL90, MF102, MF62, MF82, MF83		

			
código	695838	referencia	64007615
descripción	arandela para máquina de hielo H 5mm int.ø 17mm ø ext. 28mm PTFE		
Para modelos:	MC15, MC45		

			
código	695779	referencia	0200303301
descripción	árbol para dispensador L 47mm ø ext. 12.2mm EC 19 H M6		



1

código	695757	referencia	0200236902
descripción	arrastre para máquina de hielo L 105mm An 59mm H 31.5mm		



1

código	694103	referencia	0200365701
descripción	bandeja recoge gotas para máquina de hielo L 420mm An 55mm H 90mm		



1

código	695585	referencia	72418002
descripción	barra roscada rosca M4 L1 130mm L2 22mm		
Para modelos:	MF20, MF22, MF26, MF30, MF36, MF41, MF46, MF51, MF56, MF56ASR, MF61, MF62, MF66, MF66ASR		



1

código	695964	referencia	73310000
descripción	boquilla de tubo flexible L 27mm int.ø 8mm ø ext. 11.5mm		



1

código	696607	referencia	4114266 66048300
descripción	brida máquina de hielo H 20mm ø ext. 60mm plástico		
Para modelos:	AC225, AC226, MC1210, MC15, MC16, MC45, MC46, MC8		



1

código	695754	referencia	0A03237920
descripción	caja para mecanismo L 305mm An 180mm H 70mm		



1

código	695637	referencia	0200353801
descripción	canal de desagüe para máquina de hielo en cubitos L 420mm An 20mm plástico		



1

código	695583	referencia	0200286801
descripción	canal de desagüe para máquina de hielo en cubitos L 470mm An 45mm plástico		



1

código	691797	referencia	66047700
descripción	canal de expulsión para máquina de hielo		
Para modelos:	MC15, MC16		





1

código	695640	referencia	66067601 66067603
descripción	canal de expulsión para máquina de hielo		
Para modelos:	AF100, AF200, MF20, MF22, MF26, MF30, MF36		



 <p>1</p>			
código	691800	referencia	0200394401 1103247S&P
descripción	caño para máquina de hielo H 72mm int.ø 74mm ø ext. 80mm		

 <p>1</p>			
código	695946	referencia	0A02768701
descripción	casquillo con rosca H 27mm int.ø 16mm EC 29 izquierdo		

 <p>1</p>			
código	695765	referencia	0200299801
descripción	casquillo H 13mm int.ø 22mm ø ext. 28.5mm		

 <p>1</p>			
código	695942	referencia	02768702 0A02768702
descripción	casquillo L 41mm int.ø 16mm ø ext. 20mm rosca con paso a la izquierda		

 <p>1</p>			
código	696620	referencia	25110913/0
descripción	casquillo para máquina de hielo L 13mm An 8mm H 9mm int.ø 4mm ø ext. 8mm plástico		
Para modelos:	GP40, GP40W, GP75, GP75W, GP90, GP90W		

 <p>1</p>			
código	695588	referencia	06052700 4114227S&P
descripción	cojinete completo H 31.5mm int.ø 30mm ø ext. 89mm pos. de montaje abajo		
Para modelos:	MF41, MF46, MF51, MF56, MF56ASR, MF61, MF62, MF66, MF66ASR		

 <p>1</p>			
código	694438	referencia	4114737 66047702
descripción	cubeta L 205mm An 100mm H 19mm		
Para modelos:	MC1210, MC15, MC16, MC45, MC46		

 <p>1</p>			
código	695437	referencia	66072001
descripción	cubierta para barrera luminosa pos. de montaje derecho		
Para modelos:	AC045, AC055, AC085, AC105, AC106, AC125, AC126, AC175, AC176, AC225, AC226, EC045, MF22, MF26, MF30, MF36, MF41, MF46, MF51, MF56, MF56ASR, MF62, MF66, MF66ASR		

 <p>1</p>			
código	695436	referencia	66072000
descripción	cubierta para barrera luminosa pos. de montaje izquierdo		
Para modelos:	AC045, AC055, AC085, AC105, AC106, AC125, AC126, AC175, AC176, AC225, AC226, EC045, MF22, MF26, MF30, MF36, MF41, MF46, MF51, MF56, MF56ASR, MF62, MF66, MF66ASR		

 <p>1</p>			
código	695855	referencia	66033000
descripción	cubierta para máquina de hielo An 49mm H 44mm espesor 2mm		
Para modelos:	ACM25		

 <p>1</p>			
código	695841	referencia	66034300
descripción	deflector para máquina de hielo An 128mm H 120mm plástico		
Para modelos:	ACM25		

 <p>1</p>			
código	695638	referencia	0200340501
descripción	distribuidor 4 vías para máquina de hielo		



1			
código	695639	referencia	02970301 0A02970301
descripción	distribuidor 4 vías para máquina de hielo		



1			
código	520450	referencia	73316600
descripción	empalme de tubo L 28mm int.ø 7mm ø ext. 11.4mm rosca 3/8" UNF		



1			
código	695584	referencia	25474608 CM25474608
descripción	grapa elástica L 28mm An 10mm agujero ø 4.5mm tubo ø 31mm		
Para modelos:	MV1000, MV12, MV18, MV18-21, MV25, MV25-32, MV300, MV450, MV50, MV600, MV800		



1			
código	695630	referencia	06035900
descripción	juego de acoplamientos ø 37mm		
Para modelos:	AF10, AF100, AF20, AF200, AF30, AF80, MF20, MF22, MF26, MF30, MF36		



1			
código	695587	referencia	00102808
descripción	kit de reparación para máquina de hielo		
Para modelos:	MF41, MF46, MF51, MF56, MF56ASR, MF62, MF66, MF66ASR		
repuestos para	695587		
	código	referencia	06052700 4114227S&P
	cojinete completo H 31.5mm int.ø 30mm ø ext. 89mm pos. de montaje abajo		



1			
código	695753	referencia	66033800
descripción	manguito de goma L 25mm An 18mm H 18mm int.ø 7mm ø ext. 18mm		
Para modelos:	ACM25		



1			
código	695777	referencia	66029702
descripción	marco con expulsor L 172mm An 89mm H 195mm goma		



1			
código	695834	referencia	1300060600
descripción	membrana H 20mm int.ø 50mm ø ext. 64mm		



1			
código	694173	referencia	0200387801
descripción	placa L 345mm An 360mm H 30mm		



1			
código	691799	referencia	66030200
descripción	placa de unión para máquina de hielo L 220mm An 55mm		



1			
código	695830	referencia	64009500
descripción	protección de goma para cojinete H 11.5mm int.ø 31.5mm ø ext. 36mm		
Para modelos:	AF10, AF100, AF20, AF200, AF30, AF80, MF20, MF22, MF26, MF30, MF36		





1			
código	695831	referencia	64009501
descripción	protección de goma para cojinete H 14mm int.ø 39.5mm ø ext. 44.5mm		
Para modelos:	MF41, MF46, MF51, MF56, MF56ASR, MF61, MF62, MF66, MF66ASR		



			
1			
código	695627	referencia	03476801 0A03476801
descripción	rotor para dispensador L 285mm An 205mm		

			
1			
código	695764	referencia	72421506
descripción	sensor L 100mm ø ext. 4mm rosca M3		
Para modelos:	AF10, AF100, AF20, AF200, AF30, AF80, MF20, MF22, MF26, MF30, MF36, MF41, MF46, MF51, MF56, MF56ASR, MF61, MF62, MF66, MF66ASR		

			
1			
código	695929	referencia	02154400 0A02154400
descripción	soporte		

			
1			
código	695927	referencia	33500026 CM33500026
descripción	soporte L 12mm int.ø 5mm ø ext. 7mm		
Para modelos:	MV12, MV18, MV18-21, MV25, MV25-32		

			
1			
código	695956	referencia	4114732 81453139 CM81453139
descripción	soporte para bomba L 130mm An 85mm H 135mm		
Para modelos:	MV12, MV18-21, MV25-32		

			
1			
código	695446	referencia	72307300
descripción	soporte para inyector L 47mm An 16.5mm		
Para modelos:	ACM55, ACM85		

			
1			
código	691665	referencia	CM25726473
descripción	soporte para tapa evaporador		

			
1			
código	695762	referencia	CS0002541928
descripción	tanque de agua H 200mm int.ø 160mm		

			
1			
código	695650	referencia	0200252001 0200252002
descripción	tapa L 120mm An 83mm H 30mm plástico		

			
1			
código	695959	referencia	00770100 0A00770100
descripción	tapa para máquina de hielo H 14mm int.ø 26mm ø ext. 42mm		

			
1			
código	695876	referencia	66042700
descripción	tapa para máquina de hielo H 15mm int.ø 71mm ø ext. 76mm		

			
1			
código	695877	referencia	66049201
descripción	tapa para máquina de hielo H 17mm int.ø 89mm ø ext. 92mm		
Para modelos:	MF102, MF82, MF83		





1			
código	695733	referencia	66050700
descripción	tapa para máquina de hielo H 18mm int.ø 56mm ø ext. 61mm		
Para modelos:	MF41, MF46, MF51, MF56, MF56ASR, MF61, MF62, MF66, MF66ASR		

1			
código	695926	referencia	0002781301 CS0002781301
descripción	tapa terminal H 4mm int.ø 18mm ø ext. 22mm cromado		

1			
código	695847	referencia	1300084001
descripción	tapón montaje ø 18mm ø 22mm H 16mm goma		

1			
código	695857	referencia	66009100
descripción	tapón montaje ø 4mm ø 7mm H 13mm plástico UE 1 pzs		
Para modelos:	MAR10, MAR20, MAR30, MAR5		

1			
código	696614	referencia	66074100
descripción	tapón para máquina de hielo H 40mm int.ø 83mm ø ext. 88mm		

1			
código	695848	referencia	66034100
descripción	tapón rectangular medida de montaje 14x16mm H 8mm int.ø 10mm goma		
Para modelos:	ACM25		

1			
código	691807	referencia	CM25730503
descripción	tapón de desagüe para contenedor agua L 12mm ø 12mm		
Para modelos:	CD40, MV1000, MV12, MV18-21, MV25-32, MV300, MV450, MV456, MV50, MV600, MV800		

1			
código	695766	referencia	0200212201
descripción	tornillo rosca 7/8" plástico EC 29 izquierdo rosca L 16mm		

1			
código	695660	referencia	CM25300000
descripción	tubo de entrada para máquina de hielo ICEMATIC		

1			
código	695730	referencia	66033700
descripción	tubo nivel de agua para máquina de hielo L 20mm An 19mm H 130mm		

1			
código	695770	referencia	78445201R
descripción	tubo para refrigeración con colector		
Para modelos:	AC225		

1			
código	694127	referencia	78425202R
descripción	tubo para refrigeración con colector L 920mm		



			
1			
código	550780	referencia	03226201 0A03226201
descripción	tubo protector para capilares para máquina de hielo		

			
1			
código	695046	referencia	4114180S&P 660535.00
descripción	tuerca H 5mm rosca M24x1,5 plástico		
Para modelos:	AC045, AC046, AC055, AC056, AC085, AC086, AC105, AC106, AC125, AC125B, AC125C, AC126, AC175, AC176, AC225, AC226, ACM125, ACM175, ACM35, ACM45, ACM55, ACM85, AF10, AF100, AF20, AF200, AF30, AF80, Barline-20, Barline-21, Barline-30, Barline-31, Barline-40, Barline-50, Barline-65, Barline-90, Barline-B40, Barline-B65, Barline-B90, Barline-BUL20, Barline-BUL30, Barline-BUL40, Barline-BUL65, Barline-BUL90, EC045, ICE-ONE, ICE-THREE, ICE-TWO, MAR125, MC1210...(Otros modelos se puede ver en la tienda web)		

			
1			
código	695954	referencia	0300139401
descripción	tuerca para máquina de hielo H 6mm rosca 7/8" EC 32		

válvulas

válvulas de llenado

			
1			
código	695652	referencia	81453201 CM81453201
descripción	válvula de llenado completo rosca 3/4" L 350mm tubo ø 6mm		

			
1			
código	694548	referencia	02003612 01
descripción	válvula de llenado con flotador		

			
1			
código	696608	referencia	1124262
descripción	válvula de llenado máquina de hielo rosca 14 plástico tubo ø 35mm An 76mm		

			
1			
código	695749	referencia	0200326621 0200337121
descripción	válvula de llenado para máquina de hielo rosca 14 L 70mm plástico An 50mm espesor 20mm		

			
1			
código	695685	referencia	0200221702 CM19864010
descripción	válvula de llenado rosca M11 L 130mm ø 37mm plástico		
Para modelos:	MV18-21, MV25-32, MV50		

válvulas

			
1			
código	694123	referencia	65081100
descripción	válvula antirretorno L 72mm ø 18mm plástico empalme 12mm		
Para modelos:	EC045		

complementos de válvula

			
1			
código	695771	referencia	65010900
descripción	casquillo de válvula rosca 7/16" L 26mm ø 9.5mm latón EC 11		
Para modelos:	AC045, AC046, AC055, AC056, AC085, AC086, AC105, AC106, AC125, AC125B, AC125C, AC126, AC175, AC176, AC225, AC226, ACM125, ACM175, ACM35, ACM45, ACM55, ACM85, AF10, AF100, AF20, AF200, AF30, AF80, Barline-20, Barline-21, Barline-30, Barline-31, Barline-40, Barline-50, Barline-65, Barline-90, Barline-B40, Barline-B65, Barline-B90, Barline-BUL20, Barline-BUL30, Barline-BUL40, Barline-BUL65, Barline-BUL90, EC045, ICE-ONE, ICE-THREE, ICE-TWO, MAR1, MAR10...(Otros modelos se puede ver en la tienda web)		



para contenedores de hielo

contenedores



1

código	694204	referencia	25135163 CM25135163
descripción	contenedor de hielo L 350mm An 320mm H 260mm		
Para modelos:	CD40		



1

código	694157	referencia	66068100
descripción	contenedor de hielo L 680mm An 580mm H 840mm		

bandejas de agua condensada



1

código	694153	referencia	CM25160509
descripción	bandeja de agua condensada para contenedor de hielo L 760mm An 290mm H 32mm		
Para modelos:	B390		



1

código	694166	referencia	78207019R
descripción	contenedor de hielo L 455mm An 480mm H 470mm		

puertas



1

código	696582	referencia	CM81460355
descripción	puerta para modelo B390/B393 L 767mm An 28mm H 310mm		
Para modelos:	B390, B393		
accesorios para	696582		



código	508418	referencia	19350201
descripción	junta de gomaespuma An 15mm espesor 8mm autoadhesivo UE 1m		

para dispensadores de hielo

técnica de accionamiento y rodamientos de bolas



1

código	694174	referencia	0200375420
descripción	árbol de accionamiento L 180mm con cojinete		

cajas y paneles frontales



1

código	694172	referencia	81409176 CM81409176
descripción	caja para dispensador de hielo L 350mm An 160mm H 430mm juego		
Para modelos:	CD40		



1

código	694159	referencia	06060001
descripción	caja para dispensador de hielo L 385mm An 190mm H 815mm con botonera a membrana		



1

código	695642	referencia	06060002
descripción	juego de carcasas para dispensador de hielo L 38.5mm An 210mm H 820mm 2 piezas		



1

código	695996	referencia	66069900
descripción	panel frontal para dispensador de hielo L 116mm An 34mm H 112mm		



1

código	695994	referencia	66070000
descripción	panel frontal para dispensador de hielo L 170mm An 32mm H 125mm		

embudos



1

código	695985	referencia	0200336501
descripción	tolva para agua ø 82mm L 136mm plástico para dispensador de hielo		



1

código	695986	referencia	0200327001
descripción	tolva para hielo ø 79mm L 115mm plástico para dispensador de hielo		



1

código	694094	referencia	4114497 66067500
descripción	tolva para hielo-agua ø 85.5mm L 84mm plástico para dispensador de hielo		

grifería

grifería con pedal



1

código	695786	referencia	0002781191 CS0002781191
descripción	cable de mando ø 1.6mm L 94mm para dispensador de agua		
Para modelos:	SCW14B		

para máquinas de espresso

mirillas de nivel

mirillas de nivel

bolas



1

código	695872	referencia	66045300
descripción	esfera para flotador ø 10mm plástico		



para máquinas de café automáticas

otros

 <p>1</p>			
código	695832	referencia	61000300
descripción	anillo cortante para máquina de hielo L 6.5mm int.ø 6.2mm ø ext. 8.5mm		

para expendedoras de bebidas

sistemas de desagüe

válvulas de desagüe

 <p>1</p>			
código	695990	referencia	0000090096 CS0000090096 CS0002781307
descripción	pileta de desagüe L 56mm para expendedora de bebidas embudo empalme 19.5mm		
Para modelos:	SW12		

rejillas de drenaje

 <p>1</p>			
código	695991	referencia	6507650 65076500
descripción	rejilla de drenaje para expendedora de bebidas L 253mm An 167mm H 45mm		

pomos

pomos personalizados para fabricantes

SCOTSMAN			
 <p>1</p>			
código	111139	referencia	1100042722
descripción	pomo interruptor marca cero ø 26mm eje ø 6x4,6mm parte plana arriba negro		

manillas y volantes

asas de arco

 <p>1</p>			
código	700989	referencia	CM28190005
descripción	asa de arco L 325mm H 16mm distancia de sujeción 254mm An 36.5mm cromado		
accesorios para	700989		
	código	692526	referencia
	 cubierta para asidero plástico		

sujeciones

tornillos de retención

 <p>1</p>			
código	697741	referencia	0300072710
descripción	tornillo de retención rosca M6 asidero ø 14.5mm acero inoxidable L 13mm		

cierres

cierres angulares

cierres de palanca

otros



código	700829	referencia	0200265801
descripción	manilla de puerta L 150mm distancia de sujeción 117/133mm con taladro para candado tipo 2830		

bisagras

bandas de bisagras

específico del fabricante

CASTEL

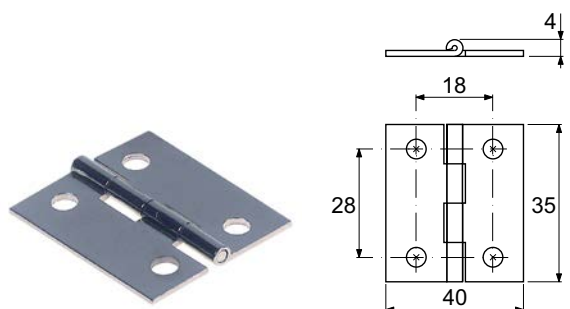

código	691804	referencia	CM19120050
descripción	bisagra L 40mm An 35mm H 4mm distancia de sujeción 28mm agujero \varnothing 5mm espesor 1.3mm latón ICEMATIC		



código	701030	referencia	CM 19120045
descripción	bisagra regulable L 43mm An 37mm agujero \varnothing 4mm para contenedor de hielo distancia de sujeción 26/32mm plástico		
Para modelos:	B193, B390, B393		

soporte de puerta



código	695776	referencia	0A03239602
descripción	cojinete giratorio L 40mm An 38mm H 40mm pos. de montaje derecho espesor 3.5mm		
Para modelos:	BH550		



código	695781	referencia	0A03239601
descripción	cojinete giratorio L 40mm An 38mm H 40mm pos. de montaje izquierdo espesor 3.5mm		
Para modelos:	BH550		



código	690583	referencia	CM19120054
descripción	cojinete giratorio sin perno		

grifería para cocinas industriales

grifos de vaciado

accesorios



código	505517	referencia	64004116
descripción	junta tórica EPDM espesor 5.34mm int. \varnothing 53.34mm UE 1 pzs		
Para modelos:	MF102, MF82, MF83		



filtros

filtros de aire



1

código	694183	referencia	0200348501
descripción	filtro de aire L 500mm An 500mm H 20mm		



1

código	694158	referencia	0200297601
descripción	filtro de aire L 640mm An 10mm H 410mm para condensador		

filtros para aparatos



1

código	970877	referencia	0200421201 3126318
descripción	filtro de aire L 335mm An 238mm H 3mm plástico para máquina de hielo		
Para modelos:	MV456		

pies para aparatos y tapas terminales

pies para aparatos

con fijación atornillada

piezas sueltas



1

código	701002	referencia	66025700 66025800 66025801 66051600
descripción	pie de aparato tubo ø 34mm H 48mm plástico rosca 1 1/4" UMF		



1

código	701093	referencia	25570880 CM25570880
descripción	pie de aparato tubo ø 47mm H 68mm plástico rosca 1 1/4" M		
Para modelos:	B190, B390		



1

código	700103	referencia	19490020 81502140 CM19490020 CM81502140
descripción	pie de aparato tubo ø 56mm dimensiones de la placamm dist. del agujeromm H 130mm inox medida 2" UE 1 pzs		
Para modelos:	B193, B390, B393		

con placa de sujeción

piezas sueltas



1

código	701002	referencia	66025700 66025800 66025801 66051600
descripción	pie de aparato tubo ø 34mm H 48mm plástico rosca 1 1/4" UMF		



1

código	701093	referencia	25570880 CM25570880
descripción	pie de aparato tubo ø 47mm H 68mm plástico rosca 1 1/4 M		
Para modelos:	B190, B390		



1

código	700103	referencia	19490020 81502140 CM19490020 CM81502140
descripción	pie de aparato tubo ø 56mm dimensiones de la placamm dist. del agujeromm H 130mm inox medida 2" UE 1 pzs		
Para modelos:	B193, B390, B393		



1

código	695917	referencia	25460020 CM25460020
descripción	pie de aparato tubo ø 63mm dimensiones de la placamm dist. del agujeromm H 100mm plástico medida 2 1/3" UE 1 pzs		
Para modelos:	B190, B390		

otros



1

código	701000	referencia	65067000
descripción	kit pies de aparato H 116-126mm plástico UE 4 pzs rosca 1" M		
Para modelos:	AC055, AC085, AC086, AC105, AC106, AC125, AC126, AC175, AC176, AC225, ACM125, ACM175, AF10, AF100, AF20, AF200, AF30, AF80, ICE-THREE, ICE-TWO		

pies enrosables



1

código	695353	referencia	65038201
descripción	pie de aparato rosca L 17mm ø 18mm H 40mm EC 24 UE 1 pzs		
Para modelos:	AC045, AC046, AC056, ACM45, Barline-20, Barline-21, Barline-30, Barline-31, Barline-BUL20, Barline-BUL30, ICE-ONE, SD18		

tapas terminales y tapones

tapones de carcasas



1

código	695857	referencia	66009100
descripción	tapón montaje ø 4mm ø 7mm H 13mm plástico UE 1 pzs		
Para modelos:	MAR10, MAR20, MAR30, MAR5		

para tubos redondos



1

código	695847	referencia	1300084001
descripción	tapón montaje ø 18mm ø 22mm H 16mm goma		

para tubos cuadrados

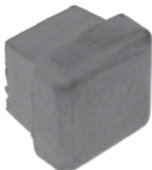

1

código	695068	referencia	4114231 66055700
descripción	tapa terminal para máquina de hielo agujero inserto 13x13mm		
Para modelos:	AC056, AC086, AC105, AC106, AC126, AC176, Barline-50, Barline-BUL30, Barline-BUL40, Barline-BUL65, Barline-BUL90, SD18		



1 

código	695848	referencia	66034100
descripción	tapón rectangular medida de montaje 14x16mm H 8mm int.ø 10mm goma		
Para modelos:	ACM25		

otros

accesorios

rollos

1 

código	700821	referencia	PROM69500811
descripción	rollo sin caja ø 150mm cuerpo de rueda plástico ancho de rueda 40mm soporte de eje ø 16.5mm		

esquinas protectoras

1  

código	695950	referencia	25550357 CM25550357
descripción	esquina protectoras longitud exterior 82mm ø boquilla interior 63mm An 19mm H 19mm distancia de sujeción 28mm dist. del agujero 20mm agujero ø 4mm goma gris		
Para modelos:	RB400		

juntas

juntas para frigoríficos

juntas insertables

perfil 9151

Fabricamos burletes personalizables de este perfil

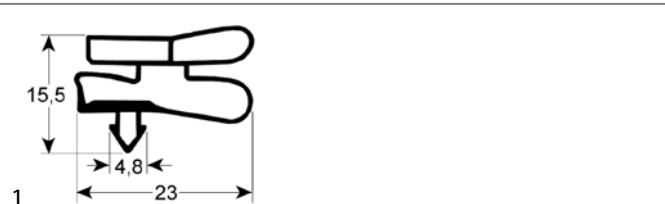

código	900368	referencia	CM28175017
descripción	junta para frigorífico perfil 9151 An 715mm L 1580mm medida inserción L1 1570mm B1 705mm medidas exteriores		

perfil 9010

Fabricamos burletes personalizables de este perfil

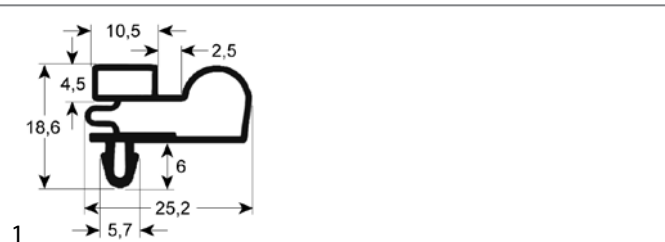

código	902251	referencia	N/A
descripción	junta para frigorífico perfil 9010 Anmm L 2500mm		

otros

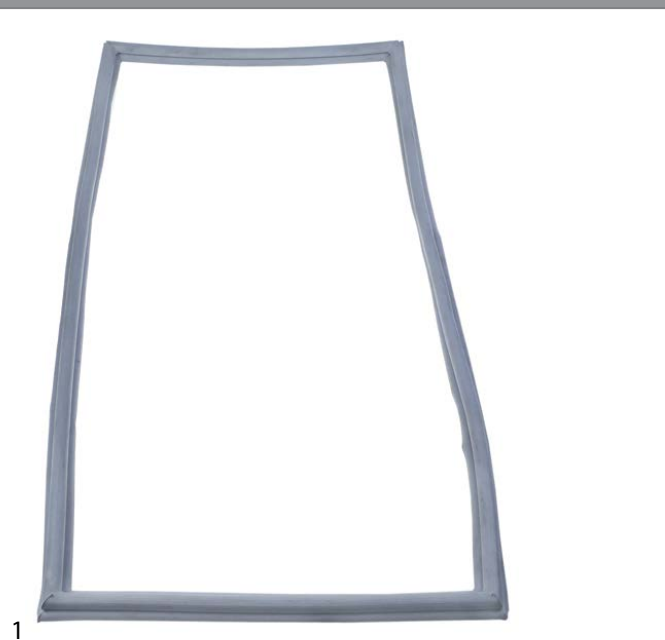

código	900891	referencia	501218 F501218
descripción	junta para frigorífico An 360mm L 770mm medida inserción		

juntas tóricas

EPDM



código	540682	referencia	1300061748
descripción	junta tórica EPDM espesor 1.78mm int.ø 18.77mm UE 1 pzs		

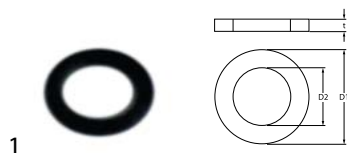

código	528485	referencia	64010000
descripción	junta tórica EPDM espesor 1.78mm int.ø 6.07mm UE 1 pzs		
Para modelos:	ACM35, AF10, AF100, AF20, AF200, AF30, AF80, MAR1, MAR10, MAR125, MAR2, MAR20, MAR3, MAR30, MAR5, MF102, MF20, MF22, MF26, MF30, MF36, MF41, MF46, MF51, MF56, MF56ASR, MF61, MF62, MF66, MF66ASR, MF82, MF83		

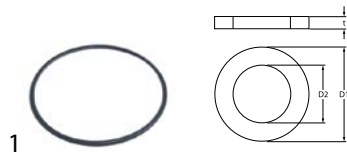

código	532030	referencia	64004127
descripción	junta tórica EPDM espesor 1.78mm int.ø 60.05mm UE 10 pzs		

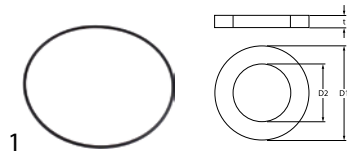

código	513275	referencia	13000617
descripción	junta tórica EPDM espesor 1.78mm int.ø 82.27mm UE 1 pzs		

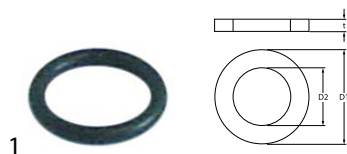

código	504574	referencia	0T514561005
descripción	junta tórica EPDM espesor 1.78mm int.ø 9.25mm UE 1 pzs		

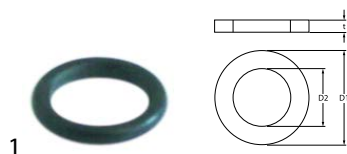

código	528110	referencia	2101016S&P 64008000
descripción	junta tórica EPDM espesor 2.62mm int.ø 12.37mm UE 1 pzs		



código	504618	referencia	1300061730
descripción	junta tórica EPDM espesor 2.62mm int.ø 15.54mm UE 1 pzs		

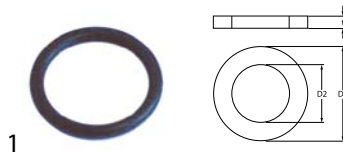

código	507309	referencia	64008100 940081.00
descripción	junta tórica EPDM espesor 2.62mm int.ø 17.13mm UE 1 pzs		

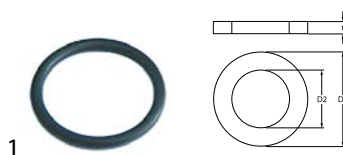

código	512071	referencia	64004125
descripción	junta tórica EPDM espesor 2.62mm int.ø 22.22mm UE 1 pzs		

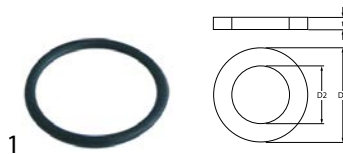

código	510769	referencia	64004101
descripción	junta tórica EPDM espesor 2.62mm int.ø 25.07mm UE 1 pzs		
Para modelos:	AF10, AF100, AF20, AF200, AF30, AF80, MF20, MF22, MF26, MF30, MF36		



código	511395	referencia	13000617.54 13-0617-54
descripción	junta tórica EPDM espesor 2.62mm int.ø 71.12mm UE 1 pzs		

código	509002	referencia	1300061732 1300061752 13-0617-52
descripción	junta tórica EPDM espesor 2.62mm int.ø 82.22mm UE 1 pzs		
Para modelos:	AutoSentry-Double-System-RL, Double-System-RL, FM1200, FM1200R, FM1202, FM1202R, FM1202RL, FM1202RL-C, FM1500, FM1500R, FM2400, FM2400R, FM2400RH, FM2402, FM2402R, FM2402RH, FM800, FM800R, FME1200, FME1200R, FME1202RL, FME1204, FME1204R, FME1204RL, FME1500, FME1500R, FME1500RL, FME1504, FME1504R, FME1504RL, FME2400, FME2400R, FME2400RH, FME2404, FME2404R, FME504AS-1A, FME504WS-1A, FME800AE-1A, FME800AE-6A, FME800AE-6B, FME800R, FME800WE-1A, FME800WE-6A, FME800WE-6B, FME804AS-1A, FME804AS-1B, FME804AS-6A, FME804AS-6B, FME804R, FME804RL...(Otros modelos se puede ver en la tienda web)		

código	532538	referencia	64004122
descripción	junta tórica EPDM espesor 3.53mm int.ø 129.8mm UE 1 pzs		
Para modelos:	MF82		

código	510896	referencia	1300061717 2101144S&P
descripción	junta tórica EPDM espesor 3.53mm int.ø 183.75mm UE 1 pzs		

código	528094	referencia	64008400
descripción	junta tórica EPDM espesor 2mm int.ø 171mm UE 1 pzs		
Para modelos:	AF10, AF100, AF20, AF200, AF30, AF80, MF20, MF22, MF26, MF30, MF36		

código	517087	referencia	1300061711 2101126S&P
descripción	junta tórica EPDM espesor 3.53mm int.ø 23.4mm UE 1 pzs		

código	361085	referencia	CM41020448
descripción	junta tórica EPDM espesor 2mm int.ø 8mm UE 1 pzs		
Para modelos:	CD40, MV1000, MV18, MV18-21, MV25, MV25-32, MV450, MV456, MV50, MV600, MV800		

código	511518	referencia	64013400
descripción	junta tórica EPDM espesor 3.53mm int.ø 23.4mm UE 10 pzs		
Para modelos:	AC045, AC046, AC055, AC056, AC085, AC086, AC105, AC106, AC125, AC125B, AC125C, AC126, AC175, AC176, AC225, AC226, ACM125, ACM175, ACM35, ACM45, ACM55, ACM85, AF10, AF20, AF30, Barline-21, Barline-31, Barline-40, Barline-50, Barline-65, Barline-90, Barline-B40, Barline-B65, Barline-B90, Barline-BUL40, Barline-BUL65, Barline-BUL90, EC045, ICE-ONE, ICE-THREE, ICE-TWO, MAR1, MAR10, MAR125, MAR2, MAR20, MAR3, MAR30, MAR5, MC8...(Otros modelos se puede ver en la tienda web)		

código	510009	referencia	64009303
descripción	junta tórica EPDM espesor 3.53mm int.ø 101.2mm UE 1 pzs		
Para modelos:	MF41, MF46, MF51, MF56, MF56ASR, MF61, MF62, MF66, MF66ASR		

código	511521	referencia	1300061756
descripción	junta tórica EPDM espesor 3.53mm int.ø 28.17mm UE 10 pzs		

código	532537	referencia	1300061718
descripción	junta tórica EPDM espesor 3.53mm int.ø 113.9mm UE 1 pzs		

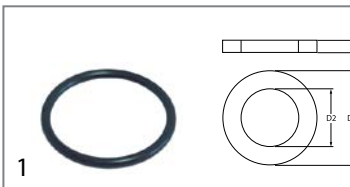

código	510895	referencia	1300061731 64009302
descripción	junta tórica EPDM espesor 3.53mm int.ø 34.52mm UE 1 pzs		
Para modelos:	MF41, MF46, MF51, MF56, MF56ASR, MF61, MF62, MF66, MF66ASR		

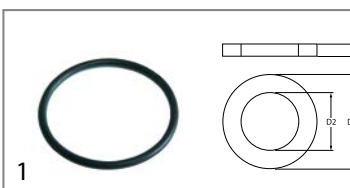

código	511531	referencia	OT514568005
descripción	junta tórica EPDM espesor 3.53mm int.ø 50.39mm UE 10 pzs		

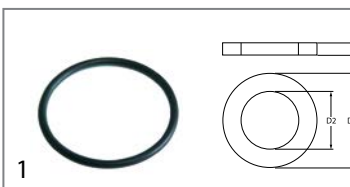

código	532114	referencia	64004138
descripción	junta tórica EPDM espesor 3.53mm int.ø 50.8mm UE 10 pzs		

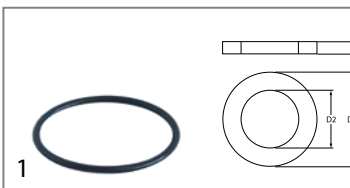

código	510973	referencia	1300061720 2101108S&P
descripción	junta tórica EPDM espesor 3.53mm int.ø 63.09mm UE 1 pzs		

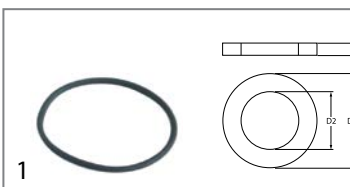

código	528902	referencia	64004128
descripción	junta tórica EPDM espesor 3.53mm int.ø 66.27mm UE 1 pzs		

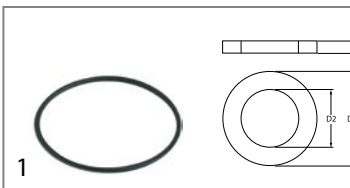

código	511711	referencia	64004115
descripción	junta tórica EPDM espesor 3.53mm int.ø 78.97mm UE 1 pzs		

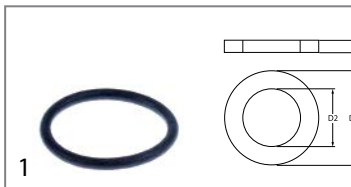

código	505517	referencia	64004116
descripción	junta tórica EPDM espesor 5.34mm int.ø 53.34mm UE 1 pzs		
Para modelos:	MF102, MF82, MF83		

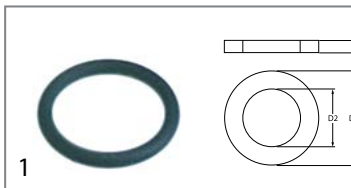

código	361304	referencia	64011000
descripción	junta tórica EPDM int.ø 11.11mm espesor 1.78mm UE 1 pzs para tipo DIB3E/DIB5E		
Para modelos:	AC125B, AC125C, AC175, AC225, ACM125, ACM35, ACM45, ACM55, ACM85		

silicona



código	695064	referencia	2101089S&P 64004120
descripción	junta tórica silicona espesor 2mm int.ø 66.4mm UE 1 pzs		
Para modelos:	AC045, AC055, AC085, AC125, AC125B, AC125C, AC126, AC175, AC176, ACM125, ACM175, ACM45, ACM55, ACM85, Barline-20, Barline-21, Barline-30, Barline-31, Barline-40, Barline-65, Barline-90, Barline-B40, Barline-B65, Barline-B90, Barline-BUL20, EC045, ICE-ONE, ICE-THREE, ICE-TWO		

Viton

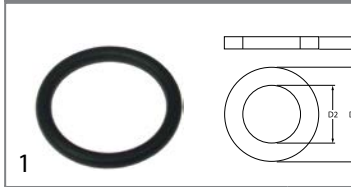

código	532518	referencia	1300061716
descripción	junta tórica Viton espesor 3.53mm int.ø 24.99mm UE 1 pzs		

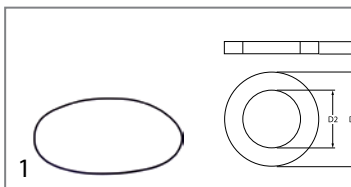

código	510218	referencia	64004114
descripción	junta tórica Viton espesor 3.53mm int.ø 291.69mm UE 1 pzs		
Para modelos:	MF102, MF82, MF83		

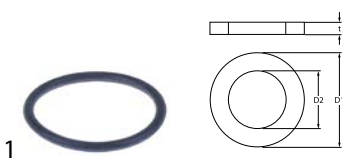

código	532539	referencia	1300061715
descripción	junta tórica Viton espesor 3.53mm int.ø 40.86mm UE 1 pzs		

NBR

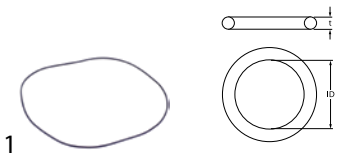

código	697879	referencia	0A026103.01 13000617.38
descripción	junta tórica NBR espesor 2.62mm int.ø 219mm UE 1 pzs		
Para modelos:	MF41, MF46, MF51, MF56, MF56ASR, MF61, MF62, MF66, MF66ASR		

anillos de junta

juntas de fibra



código	695880	referencia	64007609
descripción	junta plana fibra ø ext. 38mm int.ø 27mm espesor 1mm UE 1 pzs		
Para modelos:	MAR1, MAR10, MAR125, MAR2, MAR20, MAR3, MAR30, MAR5		

juntas de goma



código	695785	referencia	64001000
descripción	junta goma ø ext. 75mm int.ø 22mm espesor 1mm UE 1 pzs		



código	695784	referencia	64003400
descripción	junta goma ø ext. 95mm int.ø 23mm espesor 3.2mm UE 1 pzs		



código	520054 ¹	referencia	640076.13
descripción	junta plana goma ø ext. 23.5mm int.ø 14mm espesor 2.3mm UE 10 pzs		

¹UE 10 piezas

juntas de gomaespuma



código	508418	referencia	19350201
descripción	junta de gomaespuma An 15mm espesor 8mm autoadhesivo UE 1m		



código	695758	referencia	1300059500 2103176
descripción	junta de gomaespuma An 15mm espesor 8mm autoadhesivo UE 3m perfil semirredondo		



código	901292	referencia	13000595.00 2103176
descripción	junta de gomaespuma An 15mm espesor 8mm autoadhesivo UE al metro		
Para modelos:	B120, B350, B550, BH550		

juntas de árbol

juntas de árbol





código	694128	referencia	0A03237928
descripción	junta radial con revestimiento metálico int.ø 17mm ø ext. 27mm espesor 6.4mm		



código	694218	referencia	0200150300
descripción	junta radial con revestimiento metálico int.ø 22.22mm ø ext. 28.58mm espesor 3.18mm tipo CR8620		

			
1			
código	698239	referencia	0200396901 64008300
descripción	junta radial int.ø 11.91mm ø ext. 18.24mm espesor 5mm		
Para modelos:	AF10, AF100, AF20, AF200, AF30, AF80, MF20, MF22, MF26, MF30, MF36		

			
1			
código	511532	referencia	0200160600
descripción	junta radial int.ø 15mm ø ext. 25.5mm espesor 6.5mm para máquina de hielo en cubitos		
Para modelos:	MF41, MF46, MF51, MF56, MF56ASR, MF61, MF62, MF66, MF66ASR		

			
1			
código	511544	referencia	0200058024
descripción	junta radial int.ø 22.22mm ø ext. 38.07mm espesor 6.35mm tipo CR8700		

			
1			
código	695862	referencia	64009706
descripción	junta radial int.ø 220mm ø ext. 250mm espesor 15mm para máquina de hielo		
Para modelos:	MAR2, MAR20, MAR3, MAR30		

			
1			
código	511534	referencia	64001901
descripción	junta radial int.ø 22mm ø ext. 32mm espesor 5.5mm		
Para modelos:	AF10, AF100, AF20, AF200, AF30, AF80, MF20, MF22, MF26, MF30, MF36		

			
1			
código	511533	referencia	0200285301 02285301 CF02285301
descripción	junta radial int.ø 25mm ø ext. 34mm espesor 5mm para máquina de hielo		
Para modelos:	AN760, HQD550, HQD650, HQD750, MF41, MF46, MF51, MF56, MF56ASR, MF61, MF62, MF66, MF66ASR, MH750, PO760, PR760		

otros			
			
1			
código	695774	referencia	64001600
descripción	junta de árbol para motor int.ø 9mm ø ext. 45mm espesor 8mm		

juntas especiales			
otros			
			
1			
código	510217	referencia	1300086801 13-0868-01
descripción	junta		
Para modelos:	AutoSentry-Double-System-RL, Double-System-RL, FM1200, FM1200R, FM1202, FM1202R, FM1202RL, FM1202RL-C, FM1500, FM1500R, FM2400, FM2400R, FM2400RH, FM2402, FM2402R, FM2402RH, FM800, FM800R, FME1200, FME1200R, FME1202RL, FME1204, FME1204R, FME1204RL, FME1500, FME1500R, FME1500RL, FME1504, FME1504R, FME1504RL, FME2400, FME2400R, FME2400RH, FME2404, FME2404R, FME504AS-1A, FME504WS-1A, FME800AE-1A, FME800AE-6A, FME800AE-6B, FME800R, FME800WE-1A, FME800WE-6A, FME800WE-6B, FME804AS-1A, FME804AS-1B, FME804AS-6A, FME804AS-6B, FME804R, FME804RL...(Otros modelos se puede ver en la tienda web)		

componentes para el circuito frigorífico

controladores de agua de refrigeración

JOHNSON CONTROLS			
			
1			
código	541483	referencia	62011100 79305600 CM19865611 CM19870815
descripción	regulador de agua de refrigeración 3/8" tipo V46AA-9950 empalme 6mm conexión para soldadura margen de presión Mai 18bar pres. máx.agua 10bar temp.máx.agua 90°C capilar 750mm L 160mm 0.9kg		
Para modelos:	AC125, AC125B, AC125C, AC126, AC175, AC176, AC225, AC226, ACM125, ACM175, ACM35, ACM55, ACM85, AF20, AF200, AF30, AF80, Barline-65, Barline-90, Barline-B65, Barline-B90, Barline-BUL65, Barline-BUL90, CD40, MAR10, MAR125, MAR5, MC1210, MC15, MC16, MC45, MC46, MC8, MF20, MF22, MF26, MF30, MF36, MF41, MF46, MF51, MF56, MF61, MF66, MV1000, MV18, MV18-21, MV25, MV25-32, MV300...(Otros modelos se puede ver en la tienda web)		



válvulas

válvulas de expansión

DANFOSS

válvulas

tipo TS2/TE2



1

código	750014	referencia	CM81453620
descripción	válvula de expansión DANFOSS tipo TS2 refrigerante R404a/R507 acodado 90° controlado por termostato entrada 3/8" SAE salida 1/2" SAE compensación presión p máx. 34bar -40 a +10°C capilar 1500mm		
Para modelos:	MV450, MV600		
accesorios para	750014		
	código	750020	referencia —
	complmento de boquilla tamaño 0X tipo 068-2002 T/TE 2 DANFOSS		
	código	750021	referencia —
	complmento de boquilla tamaño 00 tipo 068-2003 T/TE 2 DANFOSS		
	código	750022	referencia —
	complmento de boquilla tamaño 01 tipo 068-2010 T/TE 2 DANFOSS		
	código	750023	referencia —
	complmento de boquilla tamaño 02 tipo 068-2015 T/TE 2 DANFOSS		
	código	750024	referencia —
	complmento de boquilla tamaño 03 tipo 068-2006 T/TE 2 DANFOSS		
	código	750483	referencia —
	complmento de boquilla tamaño 04 tipo 068-2007 T2/TE2 DANFOSS		
	código	750484	referencia —
	complmento de boquilla tamaño 05 tipo 068-2008 T2/TE2 DANFOSS		
	código	750485	referencia —
	complmento de boquilla tamaño 06 tipo 068-2009 T2/TE2 DANFOSS		



1

código	750178	referencia	19870826 CM19870826
descripción	válvula de expansion DANFOSS tipo TS2 refrigerante R404a/R507 acodado 90° entrada 3/8" SAE salida 1/2" SAE compensación presión p máx. 28bar -40 a -5°C capilar 1500mm		
Para modelos:	MV25-32		

tipo TX2/TEX2



1

código	750169	referencia	62048410R
descripción	válvula de expansión DANFOSS tipo TEX2 refrigerante R22 acodado 90° entrada 1/2" SAE salida 3/8" SAE compensación presión 1/2" p máx. -40 a +10bar capilar 1500mm		
Para modelos:	MF62		



1

código	750168	referencia	19870844 CM19870844
descripción	válvula de expansión DANFOSS tipo TX2 refrigerante R404a/R507 recto entrada 6.5 salida 9.5 compensación presión 13 capilar 1500mm		

HONEYWELL

válvulas



1

código	750085	referencia	1600088221 16088221
descripción	válvula de expansion		
Para modelos:	CME1202, CME1202R, CME1402, CME1402R		



1

código	750095	referencia	62042757
descripción	válvula de expansión HONEYWELL tipo AMVX boquilla ø 4,5mm entrada 5/8" UNF (3/8" SAE) salida 3/4" UNF (1/2" SAE) compensación presión 7/16" UNF (1/4" SAE) p máx. 3bar capilar 1200mm		
Para modelos:	MF82, MF83		



1

código	750445	referencia	62042755
descripción	válvula de expansión HONEYWELL tipo AMVX refrigerante R404a/R507 boquilla ø 2.5mm entrada 5/8" UNF (3/8" SAE) salida 3/4" UNF (1/2" SAE) compensación presión 7/16" UNF (1/4" SAE) p máx. 3bar capilar 1200mm		
Para modelos:	MAR125		



1

código	750076	referencia	19870607 CM19870607
descripción	válvula de expansión HONEYWELL tipo TMC refrigerante R12 controlado por termostato -45 a -5°C		



1

código	750080	referencia	19870626 CM19870626
descripción	válvula de expansión HONEYWELL tipo TMC refrigerante R22 controlado por termostato -45 a -5°C		
Para modelos:	MV25		



1

código	750425	referencia	CM19870627
descripción	válvula de expansión HONEYWELL tipo TMV-00001 refrigerante R22 acodado 90° controlado por termostato entrada 5/8" UNF (3/8" SAE) salida 3/4" UNF (1/2" SAE) compensación presión -45 a +15°C		
Para modelos:	MV50		



1

código	750129	referencia	62032610
descripción	válvula de expansión HONEYWELL tipo TMXC refrigerante R 502 entrada 5/8" UNF (3/8" SAE) salida 3/4" UNF (1/2" SAE) compensación presión 0°C capilar 2800mm		
Para modelos:	MC1210		

válvulas Schrader

complementos de válvula



1

código	750098	referencia	67001200
descripción	válvula Schrader CASTEL 8394/B R22		
Para modelos:	AC045, AC046, AC055, AC056, AC085, AC086, AC105, AC106, AC125, AC125B, AC125C, AC126, AC175, AC176, AC225, AC226, ACM125, ACM175, ACM35, ACM45, ACM55, ACM85, AF10, AF100, AF20, AF200, AF30, AF80, Barline-20, Barline-21, Barline-30, Barline-31, Barline-40, Barline-50, Barline-65, Barline-90, Barline-B40, Barline-B65, Barline-B90, Barline-BUL20, Barline-BUL30, Barline-BUL40, Barline-BUL65, Barline-BUL90, EC045, ICE-ONE, ICE-THREE, ICE-TWO, MAR125, MC1210...(Otros modelos se puede ver en la tienda web)		

filtros deshidratadores antiácidos

GMC



1

código	750086	referencia	CM19300357
descripción	deshidratador tipo SC0325 empalme ODF 1/4"-ODM 3/8" 50cm ³ p máx. 45bar -40 a +80°C 261g longitud 95mm ø 57.5mm		
Para modelos:	MV12, MV300, MV450, MV456		

otros



1

código	750244	referencia	63000305
descripción	deshidratador tamaño 15g ø 19mm L 117mm empalme 3,2/6,2mm		
Para modelos:	AC045, AC046, AC055, AC085, AC086, AC105, AC106, ACM25, ACM45, AF10, AF100, AF20, AF200, AF80, Barline-20, Barline-30, Barline-40, Barline-50, Barline-B40, Barline-BUL20, Barline-BUL30, Barline-BUL40, EC045, ICE-ONE, ICE-THREE, ICE-TWO, MF20, MF22, MF26, SD18		



1

código	750068	referencia	63000303
descripción	deshidratador tamaño 25g ø 24mm L 140mm empalme 3,5/7mm		
Para modelos:	AC125B, AC125C, AC175, ACM125, AF20, AF30, MF30		

evaporadores

para máquina de hielo en cubitos

para máquina de hielo en cubitos



1

código	695755	referencia	78429701
descripción	evaporador para máquina de hielo en cubitos 24 cubitos L 305mm An 205mm H 45mm		
Para modelos:	AC055, AC085, ACM85, ICE-THREE, ICE-TWO		

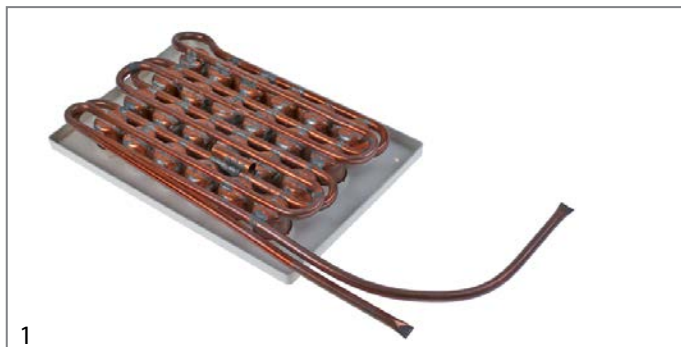

1

código	695925	referencia	78425701
descripción	evaporador para máquina de hielo en cubitos 24 cubitos L 306mm An 204mm H 45mm		



1

código	750173	referencia	78447702
descripción	evaporador para máquina de hielo en cubitos 32 cubitos L 445mm An 200mm H 45mm		
Para modelos:	AC105, Barline-50		



1

código	695923	referencia	78429801
descripción	evaporador para máquina de hielo en cubitos 42 cubitos L 310mm An 205mm H 35mm		
Para modelos:	ICE-THREE, ICE-TWO		

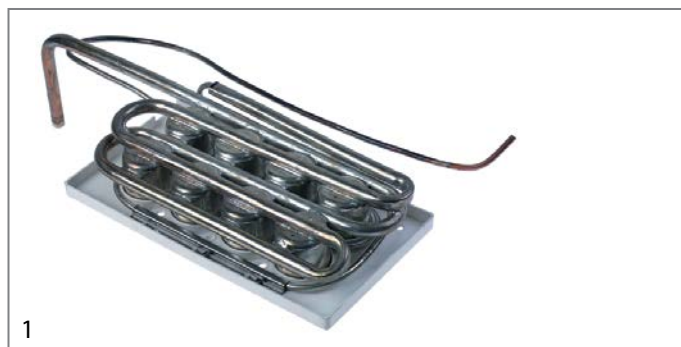

1

código	694144	referencia	78423400R
descripción	evaporador para máquina de hielo en cubitos 8 cubitos L 208mm An 110mm H 40mm		



1

código	750175	referencia	0A03029620
descripción	evaporador para máquina de hielo L 450mm An 475mm H 35mm		

para fabricante de hielo en escamas



código	694151	referencia	0A02935020
descripción	cilindro refrigerado para máquina de hielo H 295mm ø 82mm		



código	694121	referencia	78426004
descripción	evaporador H 223mm ø 74mm		
Para modelos:	AF20		



código	691791	referencia	78454101
descripción	evaporador para fabricante de hielo en escamas		



código	691793	referencia	79429802R
descripción	evaporador para fabricante de hielo en escamas		
Para modelos:	MF41, MF46		



código	691794	referencia	79424600R 79424603R
descripción	evaporador para fabricante de hielo en escamas		



código	695751	referencia	79423705R 79423706R
descripción	evaporador para fabricante de hielo en escamas Anmm H 375mm ø 73mm		
Para modelos:	MF30, MF36		



código	691792	referencia	79423611R
descripción	evaporador para fabricante de hielo en escamas con tornillo sin fin completo		



código	695893	referencia	78448300
descripción	evaporador para fabricante de hielo en escamas H 173mm ø 47mm		
Para modelos:	AF80		



código	695752	referencia	79430200R 79430201R
descripción	evaporador para fabricante de hielo en escamas H 247mm ø 73mm		
Para modelos:	AF80		



código	695745	referencia	78445900
descripción	evaporador para fabricante de hielo en escamas H 287mm ø 115mm sin tornillo sin fin		
Para modelos:	MF41, MF46		

1

código	695750	referencia	784261/03
descripción	evaporador para fabricante de hielo en escamas H 293mm ø 73mm		
Para modelos:	AF30		



1

código	695746	referencia	79423608R
descripción	evaporador para fabricante de hielo en escamas H 300mm ø 73mm		
Para modelos:	AF100, AF200		



1

código	695747	referencia	79423610R
descripción	evaporador para fabricante de hielo en escamas H 300mm ø 73mm		



1

código	695795	referencia	25339004 CM25339004
descripción	filtro de aire An 340mm H 510mm con marco espesor 6mm		



1

código	691798	referencia	66080500
descripción	filtro de aire para condensador L 410mm An 205mm		
Para modelos:	AC046, AC056		



1

código	691796	referencia	3126207S&P 66080502
descripción	filtro de aire para condensador L 495mm An 270mm		
Para modelos:	AC126, AC176, AC226, MC8		

condensadores

filtros



1

código	695736	referencia	CM25339006
descripción	filtro para condensador L 510mm An 410mm H 6mm		
Para modelos:	MV450, MV600		

condensadores



1

código	750087	referencia	19177509/0
descripción	condensador An 190mm P 60mm H 200mm		
Para modelos:	GP20		



1

código	750122	referencia	62040500
descripción	condensador An 290mm P 120mm H 270mm		
Para modelos:	AC125, AC125B, AC125C, AC126, AC175, ACM125, AF30, Barline-65, Barline-B65, Barline-BUL65, MF30, MF36		



1

código	750125	referencia	1262043900
descripción	condensador An 290mm P 85mm H 260mm		
Para modelos:	AC085, AF20, AF200, Barline-40, Barline-B40, Barline-BUL40, ICE-THREE, MF22, MF26		



1

código	750171	referencia	19177508 CM19177508
descripción	condensador An 730mm P 70mm H 605mm		
Para modelos:	MV25-32		

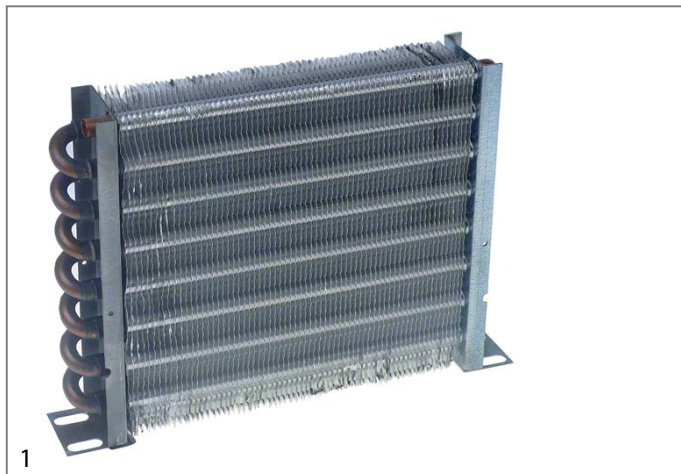

1

código	750089	referencia	62027602
descripción	condensador para máquina de hielo An 280mm P 46mm H 230mm		
Para modelos:	AC045, AC046, ACM35, ACM45, ACM55, ACM85, AF10, AF100, Barline-20, Barline-21, Barline-BUL20, EC045, ICE-ONE, MF20		



1

código	750451	referencia	CM19177072
descripción	condensador para máquina de hielo An 530mm P 80mm H 550mm		
Para modelos:	MV600		



1

código	750091	referencia	62044000
descripción	condensador para máquina de hielo An 335mm P 120mm H 270mm		
Para modelos:	AC175, AC176, ACM125, ACM175, Barline-90, Barline-B90, Barline-BUL90		

condensadores refrigerados por agua



1

código	695827	referencia	62033102
descripción	condensador tubo \varnothing 25mm \varnothing 155mm H 300mm distancia de sujeción 85mm refrigerado por agua para máquina de hielo empalme 14mm		
Para modelos:	MC1210, MC45, MC46		



1

código	695825	referencia	62033101
descripción	condensador tubo ø 25mm ø 156mm H 250mm distancia de sujeción 85mm refrigerado por agua para máquina de hielo empalme 14mm		
Para modelos:	MAR5, MC15, MC16, MF51, MF56		

técnica de accionamiento y rodapiens de bolas

correas de accionamiento

correas trapezoidales de alto rendimiento, dentadas



1

código	697743	referencia	65042221
descripción	correa trapezoidales ancho de correa 12.7mm L 750mm H 10mm CODE 732Lw perfil SPA		

muelles

muelles de torsión



1

código	695021	referencia	CM25474600
descripción	resorte de torsión ø 20.8mm L1 23.2mm L2 37mm espesor de hilo 2.3mm para máquina de hielo		



1

código	695022	referencia	CM25474602
descripción	resorte de torsión ø 21.2mm L1 26mm L2 37mm espesor de hilo 2.6mm para máquina de hielo		

resortes de compresión

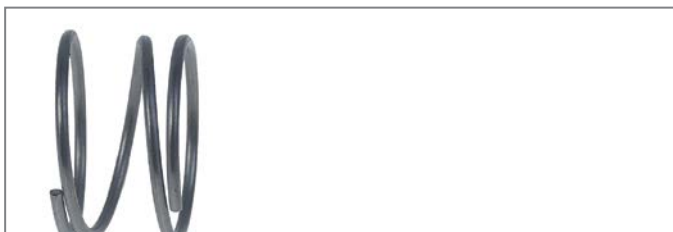

1

código	695844	referencia	65041400
descripción	resorte de compresión ø 33.4mm L 20mm espesor de hilo 2mm para racor unión		
Para modelos:	AF10, AF20, AF30		

resortes de tracción



1

código	695951	referencia	0200302201
descripción	muelle de tracción ø 10mm longitud total 410mm espesor de hilo 1mm L1 60mm L2 300mm para fabricante de hielo en escamas		

accesorios



1

código	695856	referencia	65041300
descripción	anillo int.ø 26mm H 4.7mm D1 ø 29mm D2 ø 34mm para muelle		
Para modelos:	AF10, AF20, AF30		



accesorios de cocina

gastro-norm

cubetas gastro-norm

policarbonato



1

código 993015 **referencia** T02402

descripción cubeta gastronorm policarbonato medida GN 1/3 P 150mm

accesorios para 993015



código 993096 **referencia** —

tapa policarbonato medida GN 1/3

dosificadores

bombas de membrana

autoaspirantes

SEKO

piezas de repuesto



1

código 361304 **referencia** 64011000

descripción junta tórica EPDM int.ø 11.11mm espesor 1.78mm UE 1 pzs para tipo DIB3E/DIB5E

Para modelos: AC125B, AC125C, AC175, AC225, ACM125, ACM35, ACM45, ACM55, ACM85

autoaspirantes con presión secundaria

SEKO



1

código 361304 **referencia** 64011000

descripción junta tórica EPDM int.ø 11.11mm espesor 1.78mm UE 1 pzs para tipo DIB3E/DIB5E

Para modelos: AC125B, AC125C, AC175, AC225, ACM125, ACM35, ACM45, ACM55, ACM85

tubos flexibles

tubos de salida

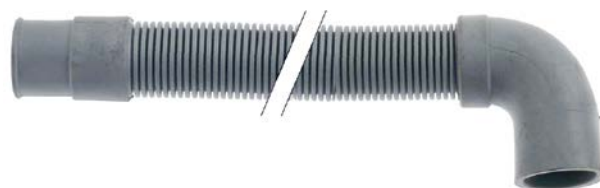

1

código 530473 **referencia** CM19810114

descripción manguera de desagüe DN19 L 1900mm ø int. recta 19mm ø ext. recto 25mm dim.ext. codo 23mm ø ext. codo 27mm tubo ø ext. 24mm para máquina de hielo

tubos flexibles industriales

tubos PE



1

código 520738 **referencia** CS0002801363

descripción tubo flexible LLDPE int.ø 6mm ø ext. 8mm L 3000mm para tecnología de bebidas John Guest

tubos flexibles de PVC

para máquina de hielo en cubitos

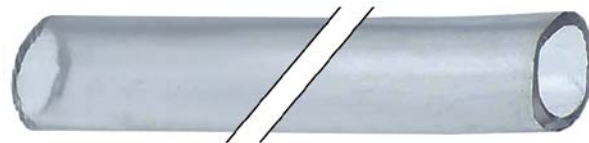

1

código 695999 **referencia** 03091801
0A03091801

descripción tubo flexible de PVC int.ø 13mm ø ext. 19mm L 11mm grosor de la pared 3mm transparente

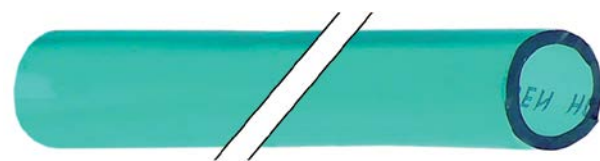

1

código 520416 **referencia** CS0002801318

descripción tubo flexible de PVC int.ø 18mm ø ext. 24mm grosor de la pared 3mm UE al metro

Para modelos: SW12

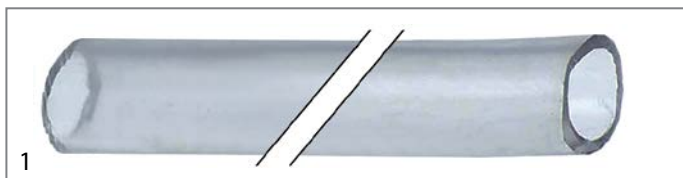

código	520448	referencia	00028013 CS00028013
descripción	tubo flexible de PVC int.ø 18mm ø ext. 24mm L 800mm grosor de la pared 3mm transparente		

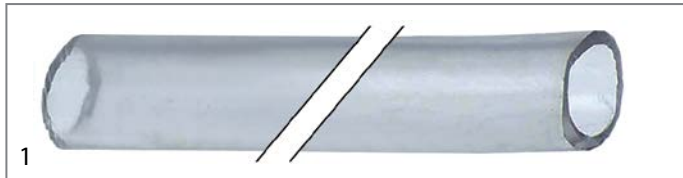

código	695896	referencia	74300000
descripción	tubo flexible de PVC int.ø 18mm ø ext. 24mm L 88mm grosor de la pared 3mm		



código	520445	referencia	0002801334 CS0002801334
descripción	tubo flexible de PVC int.ø 22mm ø ext. 30mm L 105mm grosor de la pared 4mm verde		
Para modelos:	SCW14B, SCW14S		

tubos de tejido recubiertos de PVC

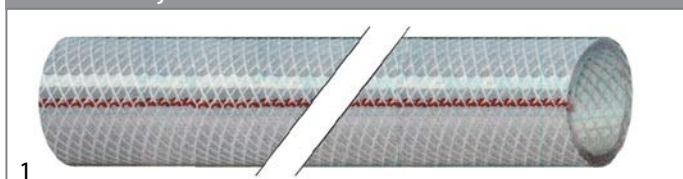

código	530565	referencia	1300067409
descripción	tubo de tejido de PVC int.ø 13mm ø ext. 19mm L 10m p de trabajo 10bar p de reventamiento 30bar T máx 60°C UE 10m		

tubos de PVC sin tejido

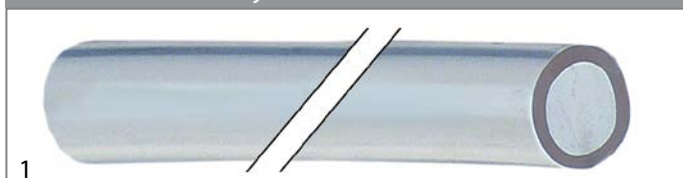

código	520440	referencia	28183004
descripción	tubo flexible de PVC int.ø 14mm ø ext. 19mm transparente PVC UE al metro		
Para modelos:	ACM35		

tubos de silicona

sin tejido

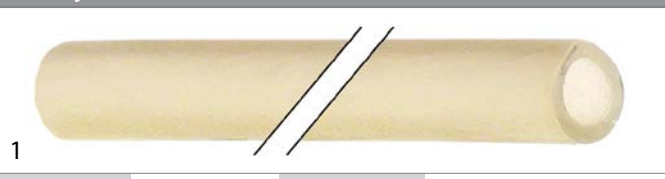

código	530769	referencia	CM25790880
descripción	tubo de silicona para máquina de hielo en cubitos int.ø 14mm ø ext. 20mm L 650mm		
Para modelos:	MV25, MV25-32		

guarniciones, empalmes para mangueras y tubos

empalmes de tubos

sin racor



código	695873	referencia	1600067101
descripción	empalme de tubo plástico tubo ø 17-17mm acodado		

guarniciones

boquillas dobles



código	520447	referencia	73320400
descripción	boquilla doble rosca 3/8" - 3/4" L1 24mm L2 12mm		
Para modelos:	AC125, AC125B, AC125C, AC126, AC175, AC176, AC225, AC226, ACM125, ACM175, ACM55, ACM85, AF20, AF200, AF30, AF80, MC1210, MC15, MC16, MC45, MC46, MC8, MF20, MF22, MF26, MF30, MF36, MF41, MF46, MF51, MF56, MF61, MF66		

reducciones



código	520188	referencia	65057500
descripción	reducción rosca 3/8" H - 3/8" M latón niquelado longitud total 24.5mm EC 22		
Para modelos:	MC15, MC16, MC45, MC46		



empalmes de tubo

específico del fabricante



1

código	695053	referencia	66029100
descripción	empalme de tubo para máquina de hielo en cubitos recto boquilla ø 11.5mm longitud boquilla 16mm EC 27 rosca L 15mm plástico G1: 3/4" G2: 5/8" UNF (3/8" SAE)		
Para modelos:	AC045, AC055, AC085, AC105, AC106, AC125, AC125B, AC125C, AC126, AC175, AC176, AC225, AC226, ACM125, ACM175, ACM35, ACM45, ACM55, ACM85, AF20, AF30, Barline-20, Barline-30, Barline-40, Barline-50, EC045, ICE-ONE, ICE-THREE, ICE-TWO, MC45, MC8		



1

código	501339	referencia	25600225 CM25600225
descripción	empalme de tubo recto int.ø 1/2"mm ø 20mm		
Para modelos:	RB400		



1

código	695875	referencia	66053400
descripción	empalme de tubo recto plástico D1 ø 12.5mm D2 ø 14mm		
Para modelos:	AC125, AC125B, AC125C, AC175, ACM125, ACM175, ACM45, ACM55, ACM85		



1

código	695050	referencia	256908060 CM25690806
descripción	empalme de tubo recto plástico L 70mm ø 21mm		
Para modelos:	CD40, GP20, GP20W, GP30, GP40, GP40W, GP50, GP50W, GP75, GP75W, GP90, GP90W, MV12, MV18-21, MV25-32, MV50		



1

código	361796	referencia	73317400
descripción	empalme de tubo rosca 3/4" M boquilla ø 13.5mm int.ø 10mm longitud boquilla 20mm EC 27 rosca L 22mm		
Para modelos:	AF20, AF200, AF30, AF80, MC1210, MC15, MC16, MC45, MC46, MF20, MF22, MF26, MF30, MF36, MF41, MF46, MF51, MF56, MF61, MF66, MF66ASR		



1

código	695921	referencia	0002521363 CS0002521363
descripción	empalme de tubo rosca 3/8" recto boquilla ø 8mm longitud boquilla 17mm EC 22 longitud total 32mm rosca L 9mm plástico		



1

código	695845	referencia	65062300
descripción	empalme de tubo rosca 3/8" tubo ø 13.5mm curvado 90° plástico		
Para modelos:	MC15, MC45		



1

código	695760	referencia	0002521360 CS0002521360
descripción	empalme de tubo rosca 3/8" tubo ø 8mm recto plástico		



1

código	695791	referencia	0200212101
descripción	empalme de tubo T plástico ø 19mm izquierdo		

racores para tubería

JOHN GUEST



1

código	440582	referencia	0002521364 CS0002521364
descripción	racor para tubería John Guest pieza T empalme de tubo ø8mm - ø8mm - ø8mm		

			
1			
código	440561	referencia	0002521375 CS0002521375
descripción	racor para tubería John Guest recto rosca 1/8" BSP empalme de tubo ø8mm		
accesorios para	440561		
	código	520972	referencia
			—
	 tubo flexible John Guest grosor de la pared 1mm LLDPE azul int.ø 6mm ø ext. 8mm		

			
1			
código	520452	referencia	0002521366 CS0002521366
descripción	racor para tubería John Guest recto rosca 7/16" UNS empalme de tubo 5/16" junta cónica		

válvulas y caños de pared

válvulas de entrada

			
1			
código	695655	referencia	19680770 CM19680770
descripción	tubo de entrada empalme 3/8" tubo ø 9mm altura total 82mm		

filtros de agua

EVERPURE

kits

			
1			
código	530049	referencia	9188001
descripción	filtro de agua juego tipo 4H empalme 3/8" vertical		

			
1			
código	530048	referencia	9188002
descripción	filtro de agua juego tipo MH empalme 3/8" vertical		

filtros

			
1			
código	530047	referencia	9188009
descripción	filtro de agua EVERPURE tipo 9498-41 B24 ø 80mm H 150mm para máquina de hielo		

cabezales de empalme

			
1			
código	530259	referencia	9188003
descripción	cabezal de filtro EVERPURE tipo QC71-MC empalme 5/8" UNF		

material auxiliar

abrazaderas

abrazaderas de tubo

DIN 3017 - W4

			
1			
código	520444	referencia	46003701
descripción	abrazadera de tubo inox W4 ø Nov 19mm ancho 9mm UE 1 pzs DIN 3017		
Para modelos:	ACM35		



abrazaderas de alambre doble



1

código	520449	referencia	0200153001 4114800
descripción	abrazadera de tubo ø 22mm espesor de hilo 3mm UE 1 pzs		

abrazaderas de encaje



1

código	520443	referencia	4114734 65049901
descripción	abrazadera de tubo ø 14-18mm plástico UE 1 pzs ancho 7mm para máquina de hielo		
Para modelos:	AC125, AC125B, AC125C, AC175, ACM125, ACM175, ACM35, ACM55, ACM85		



1

código	520441	referencia	4122489 65049900
descripción	abrazadera de tubo ø 16-20mm plástico UE 1 pzs ancho 7mm para máquina de hielo		
Para modelos:	MC1210, MC15, MC45, MF30, MF61, SD18		



1

código	520409	referencia	65049902
descripción	abrazadera de tubo ø 20-25mm plástico UE 1 pzs ancho 7mm para máquina de hielo		
Para modelos:	AC225		

material de sujeción

tornillos

tornillos de chapa



1

código	560109	referencia	47002600
descripción	tornillos de chapa ø 4.2mm L 16mm inox UE 20 pzs DIN 7981/ISO 7049 ø cabezal 8.2mm cabeza gota de sebo		
Para modelos:	AC225, MAR1, MAR2, MAR3, MC1210, MC15, MC45		

tornillos de cabeza plana



1

código	560178	referencia	0300140377
descripción	tornillo de cabeza plana rosca M5 rosca L 40mm acero UE 1 pzs soporte ranura ø cabezal 9.2mm espesor cabezal 2.7mm		
Para modelos:	MF20, MF22, MF26, MF30, MF36, MF41, MF46, MF51, MF56, MF56ASR, MF61, MF62, MF66, MF66ASR		



1

código	560073	referencia	0300140327 0300140527 03-1405-27
descripción	tornillo de cabeza plana rosca 10/32" UNF rosca L 9mm inox UE 1 pzs soporte Phillips ø cabezal 9mm		
Para modelos:	Double-System-RL, FM1200, FM1200R, FM1202, FM1202R, FM1202RL, FM1202RL-C, FM2400, FM2400R, FM2400RH, FM2402, FM2402R, FM2402RH, FME1200, FME1200R, FME1202RL, FME1204, FME1204R, FME1204RL, FME1500RL, FME1504RL, FME2400, FME2400R, FME2400RH, FME2404, FME2404R, FME804RL, NME1850, NME1850R, NME1854, NME1854R, NME950, NME950R, NME954, NME954R		

tuercas hexagonales



1

código	560079	referencia	42000026
descripción	tornillo de cabeza hexagonal rosca M6 rosca L 12mm inox EC 10 UE 20 pzs DIN 933 / ISO 4017		
Para modelos:	AF10, AF100, AF20, AF200, AF30, AF80, MF20, MF22, MF26, MF30, MF36		

tornillos de cabeza cilíndrica

DIN 912/ISO 4762



1

código	560032	referencia	42028505
descripción	tornillo de cabeza cilíndrica rosca M6 rosca L 14mm EC 5 inox UE 20 pzs DIN 912/ISO 4762		

tornillos de cabeza moleteada



1

código	694115	referencia	65080600
descripción	tornillo de cabeza moleteada rosca M5 rosca L 10mm ø 12mm H 6mm latón		
Para modelos:	AC046, AC056, AC086, AC106, AC126, AC176, AC226		



1

código	695767	referencia	0300072709
descripción	tornillo de cabeza moleteada L 10mm ø 10mm rosca M4 acero inoxidable		

tuercas

tuercas de chapa



1

código	560410	referencia	03001423 4114671
descripción	tuerca de chapa acero agujero ø 3.2mm L 18mm An 10mm		



1

código	560188	referencia	0300027100
descripción	tuerca de chapa agujero ø 2.2mm L 12mm An 6mm para máquina de hielo ømm		



1

código	560265	referencia	65016000
descripción	tuerca de chapa agujero ø 2.7mm L 42mm An 10mm para máquina de hielo ømm		

tuercas de mariposa



1

código	560145	referencia	43008300
descripción	tuerca de mariposa rosca M4 inox DIN/ISO DIN 315 UE 20 pzs		
Para modelos:	MF20, MF22, MF26, MF30, MF36, MF41, MF46, MF51, MF56, MF56ASR, MF61, MF62, MF66, MF66ASR		

tuercas hexagonales

DIN 934 / ISO 4032/8673



1

código	560132	referencia	43003300
descripción	tuerca hexagonal rosca M5 H 4mm EC 8 inox DIN/ISO DIN 934 / ISO 4032/8673 UE 20 pzs		

DIN 985



1

código	560072	referencia	PROM69500813
descripción	tuerca hexagonal rosca M16 H 16mm inox EC 24 UE 1 pzs autobloqueo		

tuercas hexagonales métricas (sin norma)



1

código	521103	referencia	0300140604
descripción	tuerca rosca M4 H 3mm EC 7 latón UE 20 pzs		

tuercas hexagonales pulgadas



1

código	695979	referencia	40005300
descripción	tuerca rosca 3/4" H 7mm latón cromado EC 32 UE 1 pzs		
Para modelos:	AC125, AC125B, AC125C, AC126, AC175, AC176, AC176, AC225, AC226, ACM125, ACM175, AF20, AF30, Barline-65, Barline-90, Barline-B65, Barline-B90, Barline-BUL65, Barline-BUL90, MC8, MF102, MF62, MF82, MF83		



arandelas

arandelas elásticas



código	695659	referencia	46004100
descripción	arandela de muelle int.ø 32mm ø ext. 39mm UE 1 pzs		
Para modelos:	MF41, MF46, MF51, MF56, MF56ASR, MF61, MF62, MF66, MF66ASR		

arandelas

otros



código	560093	referencia	44180008
descripción	arandela int.ø 10mm ø ext. 19mm espesor 0.3mm acero UE 1 pzs		
Para modelos:	AF10, AF100, AF20, AF200, AF30, AF80, MF20, MF22, MF26, MF30, MF36		



código	560092	referencia	44180007
descripción	arandela int.ø 10mm ø ext. 19mm espesor 0.8mm acero UE 1 pzs		
Para modelos:	AF10, AF100, AF20, AF200, AF30, AF80, MF20, MF22, MF26, MF30, MF36		



código	560167	referencia	4114311 44180009
descripción	arandela int.ø 12mm ø ext. 16mm espesor 0.8mm acero UE 1 pzs		
Para modelos:	AF10, AF100, AF20, AF200, AF30, AF80, MF20, MF22, MF26, MF30, MF36		



código	560144	referencia	0300140824 03140824
descripción	arandela int.ø 13mm ø ext. 22mm espesor 0.8mm acero UE 1 pzs		
Para modelos:	AF430, AF730, AN760, HQD550, HQD650, HQD750, MF41, MF46, MF51, MF56, MF56ASR, MF61, MF62, MF66, MF66ASR, MF6C, MF900RC, MH750, PO760, PR760		



código	560166	referencia	2102337 44001306
descripción	arandela int.ø 16.2mm ø ext. 21mm espesor 0.8mm inox UE 1 pzs		
Para modelos:	AC225, AC226, MC1210, MC15, MC16, MC45, MC46, MC8		



código	560094	referencia	44180004
descripción	arandela int.ø 17mm ø ext. 24mm espesor 0.5mm acero UE 1 pzs		
Para modelos:	MF41, MF46, MF51, MF56, MF56ASR, MF61, MF62, MF66, MF66ASR		



código	560152	referencia	44180800
descripción	arandela int.ø 23mm ø ext. 29mm espesor 1.5mm acero UE 1 pzs		
Para modelos:	AF10, AF100, AF20, AF200, AF30, AF80, MF20, MF22, MF26, MF30, MF36		



código	560568	referencia	0200167900 02001681 02167900 02168100
descripción	arandela int.ø 25.6mm ø ext. 39mm espesor 0.85mm inox UE 1 pzs		
Para modelos:	AF730, AN760, HQD550, HQD650, HQD750, MF41, MF46, MF51, MF56, MF56ASR, MF61, MF62, MF66, MF66ASR, MF6C, MF900RC, MH750, PO760, PR760		



código	560149	referencia	0200168100
descripción	arandela int.ø 25.6mm ø ext. 39mm espesor 0.8mm acero UE 1 pzs		
Para modelos:	MF41, MF46, MF51, MF56, MF56ASR, MF61, MF62, MF66, MF66ASR		



código	560074	referencia	44180005
descripción	arandela int.ø 8.5mm ø ext. 14mm espesor 0.3mm acero UE 1 pzs		
Para modelos:	AF10, AF100, AF20, AF200, AF30, AF80, MF20, MF22, MF26, MF30, MF36		

			
1			
código	560091	referencia	4114317 44180006
descripción	arandela int.ø 8.5mm ø ext. 14mm espesor 0.8mm acero UE 1 pzs		
Para modelos:	AF10, AF100, AF20, AF200, AF30, AF80, MF20, MF22, MF26, MF30, MF36		

sujeciones

clips de fijación

			
1			
código	524387	referencia	65020800
descripción	grapa elástica ø nominal 7mm acero L 30mm An 16mm H 14mm distancia de sujeciónmm		

tornillos de fijación

			
1			
código	524030	referencia	1500041100 4114691
descripción	perno ø nominal 7mm rosca M4x0,8 L 13mm		

bridas para cables

			
1			
código	550253	referencia	65027800
descripción	brida para cables An 3.6mm L 290mm blanco UE 100 pzs nylon		

tuerca de ranura

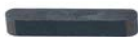
			
1			
código	560181	referencia	74109200
descripción	tuerca de ranura An 6mm H 6mm L 40mm		
Para modelos:	MAR2, MAR3		

			
1			
código	694214	referencia	0300163001
descripción	tuerca de ranura An 6.4mm H 7.6mm L 16mm especial para máquina de hielo		

clips para tubo

			
1			
código	695584	referencia	25474608 CM25474608
descripción	grapa elástica L 28mm An 10mm agujero ø 4.5mm tubo ø 31mm		
Para modelos:	MV1000, MV12, MV18, MV18-21, MV25, MV25-32, MV300, MV450, MV50, MV600, MV800		

abrazaderas

abrazaderas de tubo

DIN 3017 - W4

			
1			
código	520444	referencia	46003701
descripción	abrazadera de tubo inox W4 ø Nov 19mm ancho 9mm UE 1 pzs DIN 3017		
Para modelos:	ACM35		

abrazaderas de alambre doble

			
1			
código	520449	referencia	0200153001 4114800
descripción	abrazadera de tubo ø 22mm espesor de hilo 3mm UE 1 pzs		

abrazaderas de encaje

			
1			
código	520443	referencia	4114734 65049901
descripción	abrazadera de tubo ø 14-18mm plástico UE 1 pzs ancho 7mm para máquina de hielo		
Para modelos:	AC125, AC125B, AC125C, AC175, ACM125, ACM175, ACM35, ACM55, ACM85		



<p>1</p>			
código	520441	referencia	4122489 65049900
descripción	abrazadera de tubo ø 16-20mm plástico UE 1 pzs ancho 7mm para máquina de hielo		
Para modelos:	MC1210, MC15, MC45, MF30, MF61, SD18		

<p>1</p>			
código	520409	referencia	65049902
descripción	abrazadera de tubo ø 20-25mm plástico UE 1 pzs ancho 7mm para máquina de hielo		
Para modelos:	AC225		

anillos truarc			
DIN 472			
<p>1</p>			
código	695955	referencia	0300155804
descripción	anillo truarc taladro ø 65mm espesor 2mm acero DIN 472		

<p>1</p>			
código	695829	referencia	46004400
descripción	anillo truarc taladro ø 85mm espesor 2.5mm acero inoxidable DIN 472 para máquina de hielo		
Para modelos:	MF102, MF82, MF83		

DIN 6799			
<p>1</p>			
código	523004	referencia	0300153909
descripción	anillo truarc E D1 ø 5mm D2 ø 13.5mm inox DIN 6799 espesor 0.7mm para árbol ø 6-8mm		

<p>1</p>			
código	507015	referencia	CF46003802
descripción	anillo truarc E D1 ø 7mm D2 ø 14mm inox DIN 6799 espesor 0.9mm para árbol ø 8-11mm		

consumibles

lubricantes

lubricantes para máquinas

<p>1</p>			
código	890003	referencia	06029401
descripción	grasa para máquina 1000g		
descripción			
Para modelos:	AF10, AF100, AF20, AF200, AF30, AF80, MF20, MF22, MF26, MF30, MF36, MF41, MF46, MF51, MF56ASR, MF61, MF62, MF66, MF66ASR		

<p>1</p>			
código	890029	referencia	06029404
descripción	grasa para máquina Mobilux EP004 toma 500g para mecanismo -25 a +120°C		
descripción	<p>Mobilux EP004 - toma 500g</p> <p>Adecuada para lubricar engranajes y cojinetes cerrados en cajas de engranajes de baja estanqueidad, exceptuando los rodamientos de motores eléctricos. También puede utilizarse para muchas otras aplicaciones industriales, como por ej. cajas de engranajes y cadenas, donde los aceites convencionales para engranajes se derramarían de los dispositivos debido a fugas por juntas desgastadas o faltantes. Ha cumplido los requerimientos del ensayo de engranajes SEW 1008 horas, DR.EM.2003 mod.</p> <p>Resistencia a temperaturas: -25°C a +120°C</p>		

			
1			
código	890002	referencia	26361200
descripción	grasa para máquina White Food Grade para alimentos -25 a +150°C homologación NSF 200g		
descripción			
Para modelos:	AF10, AF100, AF20, AF200, AF30, AF80, MF20, MF22, MF26, MF30, MF36, MF41, MF46, MF51, MF56, MF56ASR, MF61, MF62, MF66, MF66ASR		

aceites			
aceite para engranajes			
			
1			
código	890004	referencia	03237927 0A03237927 A32379-027
descripción	aceite para engranajes 450g		
Para modelos:	AF325, AFE400, AutoSentry-Double-System-RL, Double-System-RL, FDE470AE-1A, FDE470AE-6A, FDE470AS-1A, FDE470AS-6A, FDE474AS-1A, FDE474AS-6A, FM1200, FM1200R, FM1202, FM1202R, FM1202RL, FM1202RL-C, FM1500, FM1500R, FM2400, FM2400R, FM2400RH, FM2402, FM2402R, FM2402RH, FM800, FM800R, FME1200, FME1200R, FME1202RL, FME1204, FME1204R, FME1204RL, FME1500, FME1500R, FME1500RL, FME1504, FME1504R, FME1504RL, FME2400, FME2400R, FME2400RH, FME2404, FME2404R, FME504AS-1A, FME504WS-1A, FME800AE-1A, FME800AE-6A, FME800AE-6B, FME800R, FME800WE-1A...(Otros modelos se puede ver en la tienda web)		

detergentes			
descalcificadores			
			
1			
código	802164	referencia	00100902 1143046
descripción	descalcificador 4.8l ácido fosfórico para máquina de hielo		

fusibles			
fusibles finos			
			
1			
código	358611	referencia	63001510
descripción	fusible fino medida ø5x20mm 16A rápido nominal 250V UE 10 pzs		
Para modelos:	AC045, AC055, AC085, AC105, AC125, AC125B, AC125C, AC175, AC225, ACM125, ACM175, ACM35, ACM45, ACM55, ACM85, AF10, AF100, AF20, AF200, AF30, AF80, Barline-B40, Barline-B65, Barline-B90, Barline-BUL20, Barline-BUL30, Barline-BUL40, Barline-BUL65, Barline-BUL90, MC1210, MC15, MC45, MF20, MF30, MF61		

			
1			
código	358509	referencia	63001511
descripción	fusible fino medida ø5x20mm 0.05A retardado nominal 250V UE 1 pzs		
Para modelos:	AC045, AC055, ACM35, ACM45, ACM55, Barline-BUL20, Barline-BUL30		

			
1			
código	358592	referencia	63001509
descripción	fusible fino medida ø5x20mm 0.1A retardado nominal 250V UE 10 pzs		
Para modelos:	AC085, AC105, AC125, AC125B, AC125C, AC175, AC225, ACM125, ACM175, ACM85, AF10, AF100, AF20, AF200, AF30, AF80, Barline-B40, Barline-B65, Barline-B90, Barline-BUL40, Barline-BUL65, Barline-BUL90, MC1210, MC15, MC45, MF20, MF30, MF41, MF51, MF61		

A			
abrazaderas	108, 112		
abrazaderas de alambre doble	109, 112		
abrazaderas de encaje	109, 112		
abrazaderas de tubo	108, 112		
accesorios eléctricos	46		
aceites	114		
anillos de junta	95		
anillos truarc	113		
arandelas	111		
arandelas elásticas	111		
B			
bandas de bisagras	88		
bombas	41		
bombas para máquinas de cubitos de hielo	41		
boquillas dobles	106		
bridas para cables	112		
C			
cables	46		
cables de cinta plana	46		
cables de enlace	47		
cierres angulares	88		
cierres de palanca	88		
clips de fijación	112		
clips para bulbo	6		
clips para tubo	112		
componentes para el circuito frigorífico	96		
compresores	30		
condensadores de arranque	44		
condensadores de servicio	45		
condensadores y filtros antiparasitarios	44		
consumibles	113		
contactores	13		
controladores de agua de refrigeración	96		
D			
descalcificadores	114		
detergentes	114		
dosificadores	105		
E			
empalmes de tubo	107		
empalmes de tubos	106		
evaporadores	99		
F			
filtros de agua	108		
filtros deshidratadores antiácidos	98		
fundas protectoras	47		
fusibles	46, 114		
		fusibles finos	114
G			
		gastro-norm	105
		guarniciones	106
I			
		interruptor de palanca	7
		interruptores centrífugos	9
		interruptores de contacto	9
		interruptores de flotador	8
		interruptores magnéticos	10
		interruptores pulsantes y pulsadores	7
		interruptores y pulsadores	6
		interruptores/pulsadores basculantes	6
J			
		juntas de árbol	95
		juntas de gomaespuma	95
		juntas insertables	91
		juntas para frigoríficos	91
		juntas tóricas	92
L			
		lámparas	11
		lámparas de señalización	11
		lámparas de señalización completas	11
		lubricantes	113
		lubricantes para máquinas	113
M			
		material de sujeción	109
		microinterruptores	7
		motores	38
		motores refrigeración universales	34
P			
		presostatos	28
R			
		racores para tubería	107
		reducciones	106
		relés	14
		relés de temporización	14
		ruedas para aparatos y esquinas protectoras	91
S			
		sensores	15
		sensores Hall	16
		sujeciones	112
T			
		tapas terminales y tapones	90

temporizadores	11
temporizadores de programa	11
terminales	47
terminales de cable y conectores	47
termostatos	3
termostatos para frío	3
tornillos	109
tornillos de cabeza cilíndrica	110
tornillos de cabeza moleteada	110
tornillos de cabeza plana	109
tornillos de chapa	109
tornillos de fijación	112
transformadores	15
tubos de entrada	108
tubos de salida	105
tubos de silicona	106
tubos flexibles	105
tubos flexibles de PVC	105
tubos flexibles industriales	105
tubos PE	105
tuercas	110
tuercas de chapa	110
tuercas de mariposa	110
tuercas de ranura	112
tuercas hexagonales	109, 110

V

válvulas de entrada	108
válvulas de expansión	97
válvulas magnéticas	21
válvulas Schrader	98
válvulas y caños de pared	108
ventiladores	34
ventiladores para frigoríficos	34
ventiladores radiales	38
ventiladores tangenciales	38