



COMPONENTES GAS



COMPONENTES ELÉCTRICOS



TECNOLOGÍA DEL AGUA



COMPONENTES MECÁNICOS



HERRAMIENTAS

Repuestos adaptables a

FIREX

Encuentre nuestra gama siempre actualizada en la tienda online de GEV



Catálogo de fabricantes

Las piezas de repuesto y accesorios más importantes de cada fabricante reunidas y ordenadas de manera práctica

- ✓ En la tienda online GEV encontrará el surtido completo y toda la información actualizada de máquinas y aparatos
- ✓ Índice alfabético al final del catálogo

Tienda online GEV

www.gev-online.es
www.gev-online.com



- 🔍 marcar artículos como favoritos
- 🔍 acceso mediante su e-mail y su contraseña habitual
- 🔍 ponga en la cesta de la compra, múltiples artículos a la vez
- 🔍 búsqueda de artículos inmediata sin necesidad conectarse

resistencias

resistencias para sartenes basculantes





código	416692	referencia	40400082
descripción	resistencia sartén basculante 2900W 230V L 312mm An 200mm H 82mm empalme M5 resistencia seca espirales 1 tubo ø 8.5mm B1 66mm B2 68mm distancia de empalme 61mm		



resistencias de inmersión

brida 3 orificios ø 47,5mm



código	416834	referencia	40400040
descripción	resistencia 8000W 230V montaje ø 47.5mm espirales 3 L 323mm An 35mm H 45mm casquillo portasondas 1 ø casquillo portasondas 7mm longitud casquillo portasondas 263mm casquillo termostato descentrado, ceñido tubo ø 8.5mm dist. del agujero 64mm agujero ø 8mm empalme M4 brida 3 orificios resistencia de inmersión		
accesorios para	416834		
	código	referencia	—
	510408		
	junta tórica EPDM espesor 5.34mm int.ø 47mm UE 1 pzs		
	código	referencia	—
	510562		
	junta tórica silicona espesor 5.34mm int.ø 47mm UE 1 pzs		



código	416835	referencia	40400042
descripción	resistencia 9000W 230V montaje ø 47.5mm espirales 3 L 415mm An 30mm H 46mm casquillo portasondas 1 ø casquillo portasondas 7.5mm longitud casquillo portasondas 255mm casquillo termostato descentrado, ceñido dist. del agujero 62mm agujero ø 8mm empalme M4 brida 3 orificios resistencia de inmersión		
Para modelos:	KPI15ETA-GIGA, KPI15ET-GIGA, KPI30ETA-GIGA, KPI30ET-GIGA, KPI50ETA-GIGA, KPI50ET-GIGA		
accesorios para	416835		
	código	referencia	—
	510408		
	junta tórica EPDM espesor 5.34mm int.ø 47mm UE 1 pzs		
	código	referencia	—
	510562		
	junta tórica silicona espesor 5.34mm int.ø 47mm UE 1 pzs		



código	419113	referencia	40400038
descripción	resistencia 9000W 230V montaje ø 47.5mm espirales 3 L 550mm An 38mm H 45mm casquillo portasondas 1 ø casquillo portasondas 7.3mm longitud casquillo portasondas 260mm tubo ø 8.5mm empalme M4 brida 3 orificios resistencia de inmersión L1 55mm H1 33mm H2 34mm		
accesorios para	419113		
	código	referencia	—
	510408		
	junta tórica EPDM espesor 5.34mm int.ø 47mm UE 1 pzs		

grupo 7



código	418505	referencia	40400048
descripción	resistencia 8000W 230V espirales 3 brida ø 47.5mm L 497mm An 35mm H 56mm tubo ø 8.5mm ø casquillo portasondas 7.5mm longitud casquillo portasondas 266mm casquillo portasondas 1 casquillo termostato no ajustado empalme M4 resistencia de inmersión brida 3 orificios dist. del agujero 58mm montaje ø 47.5mm agujero ø 8mm		
Para modelos:	KPI10ETA-GIGA, KPI10ET-GIGA, KPI20ETA-GIGA		
accesorios para	418505		
	código	referencia	—
	510408		
	junta tórica EPDM espesor 5.34mm int.ø 47mm UE 1 pzs		
	código	referencia	—
	510562		
	junta tórica silicona espesor 5.34mm int.ø 47mm UE 1 pzs		



termostatos

termostatos de control y seguridad

EGO

termostatos de regulación

serie 55.10/19_

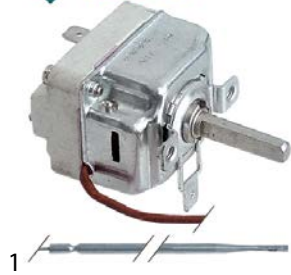

código	375363	referencia	40100050
descripción	termóstato T máx 161°C margen de trabajo 73-161°C 1 polos 1NO 16A sonda ø 3mm sonda L 144mm capilar 1600mm aislamiento del capilar 1600mm prensaestopas eje ø 6x4,6mm eje L 23mm posición del eje arriba ángulo de rotación 270°		
Para modelos:	KPI10ETA-GIGA, KPI10ET-GIGA, KPI15ETA-GIGA, KPI15ET-GIGA, KPI20EA-GIGA, KPI20E-GIGA, KPI20ETA-GIGA, KPI20ET-GIGA, KPI30EA-GIGA, KPI30E-GIGA, KPI30ETA-GIGA, KPI30ET-GIGA, KPI50EA-GIGA, KPI50E-GIGA, KPI50ETA-GIGA, KPI50ET-GIGA		

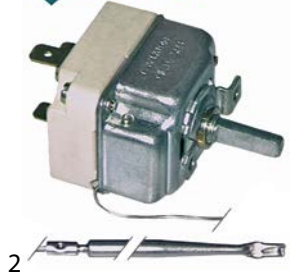

código	375270	referencia	40100042
descripción	termóstato T máx 295°C margen de trabajo 45-295°C 1 polos 1NO 16A sonda ø 4mm sonda L 100mm capilar 900mm aislamiento del capilar 350mm prensaestopas eje L 23mm posición del eje arriba ángulo de rotación 270°		

termostatos de seguridad

serie 55.32_

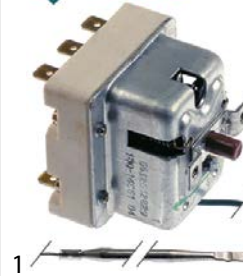

código	375364	referencia	40100041
descripción	termostato de seguridad temp. desconexión 190°C 3 polos 20A sonda ø 4mm sonda L 120mm capilar 3000mm aislamiento del capilar 3000mm prensaestopas bulbo		
Para modelos:	KPI10ETA-GIGA, KPI10ET-GIGA, KPI15ETA-GIGA, KPI15ET-GIGA, KPI20ETA-GIGA, KPI20ET-GIGA, KPI30ETA-GIGA, KPI30ET-GIGA, KPI50ETA-GIGA, KPI50ET-GIGA, PM9.G170GN-FAGOR, PM9.G270GN-FAGOR, PM9.G370GN-FAGOR		

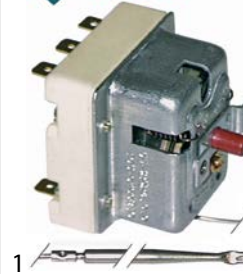

código	375350	referencia	40100062
descripción	termostato de seguridad temp. desconexión 360°C 3 polos 20A sonda ø 4mm sonda L 120mm capilar 1800mm aislamiento del capilar 1800mm prensaestopas bulbo inox		

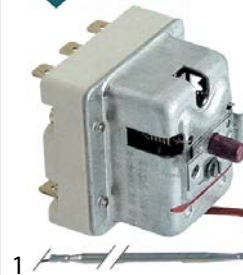

código	390227	referencia	40100062
descripción	termostato de seguridad temp. desconexión 360°C 3 polos 20A sonda ø 4mm sonda L 120mm capilar 1800mm aislamiento del capilar 1800mm prensaestopas bulbo inox		
Para modelos:	KPI20EA-GIGA, KPI20E-GIGA, KPI30EA-GIGA, KPI30E-GIGA, KPI50EA-GIGA, KPI50E-GIGA		



accesorios

accesorios para prensaestopas

conducciones de paso



código	550148	referencia	10400188
descripción	conducción para prensaestopas M M12x0,75 H M9x1 sonda ø máx. 6,5mm EC 17 silicona		

interruptores y pulsadores

interruptores pulsantes y pulsadores

ø25mm



código	345038	referencia	40100034
descripción	pulsador montaje ø 25mm negro 2NO 250V 16A empalme conector Faston 6,3mm temperatura ambiente máx. 85°C protección IP40		
Para modelos:	PM9.G170GN-FAGOR, PM9.G270GN-FAGOR, PM9.G370GN-FAGOR		



código	345039	referencia	40100036
descripción	cubierta protectora redondo ø ext. 33mm dimensiones exteriores 23mm dimensión interior 21mm H 12mm claro montaje ø 25mm		
Para modelos:	PM9.G170GN-FAGOR, PM9.G270GN-FAGOR, PM9.G370GN-FAGOR		

accesorios para	345039	código	345001	referencia	—
descripción	pulsador montaje ø 25mm amarillo 1NO/lámpara 250V 16A cubierta empalme conector Faston 6,3mm temperatura ambiente máx. 85°C protección IP65				

microinterruptores

accionado por palanca



código	345044	referencia	40100007
descripción	microinterruptor con manilla 250V 16A 1CO empalme conector Faston 6,3mm temperatura ambiente máx. 85°C distancia de sujeción 25mm tipo C99ZP3 fuerza de accionamiento: 25g longitud de palanca 71mm		

accionados por palanca de rodillo

microinterruptores



código	347272	referencia	40100122
descripción	microinterruptor con palanca de rodillo 250V 16A 1CO empalme conector Faston temperatura ambiente máx. 85°C distancia de sujeción 22,2mm blanco longitud de palanca 20mm		

conmutadores de levas

3 posiciones de conmutación



código	300167	referencia	40100004 40100004+SMP0936-00+SMP0938-00
descripción	conmutador de levas 3-posiciones de conmutación 2NO/1CO secuencia de conmutación 0-1-2 16A eje ø 6x4,6mm eje L 23mm empalme atornillado		
Para modelos:	KPI10ETA-GIGA, KPI10ET-GIGA, KPI15ETA-GIGA, KPI15ET-GIGA, KPI20EA-GIGA, KPI20E-GIGA, KPI20ETA-GIGA, KPI20ET-GIGA, KPI30EA-GIGA, KPI30E-GIGA, KPI30ETA-GIGA, KPI30ET-GIGA, KPI50EA-GIGA, KPI50E-GIGA, KPI50ETA-GIGA, KPI50ET-GIGA		

lámparas

lámparas de señalización

lámparas de señalización 2 piezas (lente y elemento)

elementos de señalización para casquillo tipo SRZ / SDK / SDY / SFK



código	359133	referencia	40200154
descripción	elemento de señalización 400V verde empalme conector Faston 6,3mm		
Para modelos:	KPI10ETA-GIGA, KPI10ET-GIGA, KPI15ETA-GIGA, KPI15ET-GIGA, KPI20EA-GIGA, KPI20E-GIGA, KPI20ETA-GIGA, KPI20ET-GIGA, KPI30EA-GIGA, KPI30E-GIGA, KPI30ETA-GIGA, KPI30ET-GIGA, KPI50EA-GIGA, KPI50E-GIGA, KPI50ETA-GIGA, KPI50ET-GIGA		

lámparas de señalización completas

ø12mm

con casquillo roscado



1

código	359290	referencia	40200150
descripción	lámpara de señalización ø 12mm 400V amarillo empalme conector Faston 6,3mm		
Para modelos:	KPI10ETA-GIGA, KPI10ET-GIGA, KPI15ETA-GIGA, KPI15ET-GIGA, KPI20EA-GIGA, KPI20E-GIGA, KPI20ETA-GIGA, KPI20ET-GIGA, KPI30EA-GIGA, KPI30E-GIGA, KPI30ETA-GIGA, KPI30ET-GIGA, KPI50EA-GIGA, KPI50E-GIGA, KPI50ETA-GIGA, KPI50ET-GIGA		



1

código	359292	referencia	40200148
descripción	lámpara de señalización ø 12mm 400V rojo empalme conector Faston 6,3mm		
Para modelos:	KPI10ETA-GIGA, KPI10ET-GIGA, KPI15ETA-GIGA, KPI15ET-GIGA, KPI20ETA-GIGA, KPI20E-GIGA, KPI20ETA-GIGA, KPI20ET-GIGA, KPI30ETA-GIGA, KPI30E-GIGA, KPI30ETA-GIGA, KPI30ET-GIGA, KPI50ETA-GIGA, KPI50E-GIGA		



1



código	359291	referencia	40200152
descripción	lámpara de señalización ø 12mm 400V verde empalme conector Faston 6,3mm		
Para modelos:	KPI10ETA-GIGA, KPI10ET-GIGA, KPI15ETA-GIGA, KPI15ET-GIGA, KPI20EA-GIGA, KPI20E-GIGA, KPI20ETA-GIGA, KPI20ET-GIGA, KPI30EA-GIGA, KPI30E-GIGA, KPI30ETA-GIGA, KPI30ET-GIGA, KPI50EA-GIGA, KPI50E-GIGA, KPI50ETA-GIGA, KPI50ET-GIGA		

temporizadores

temporizadores mecánicos



1

código	350176	referencia	40100158
descripción	temporizador C20 2 polos tiempo de funcionamiento 5min 2NO a 250 V 16A posición permanente no eje ø 6x4,6mm eje L 20mm distancia de sujeción 28mm		
accesorios para	350176		
	código	110366	referencia —
	pomo interruptor marca cero T máx°C°C ø 44mm eje ø 6x4,6mm parte plana arriba negro		
	código	112138	referencia —
	escala circular graduación 5min posición permanente no ángulo de rotación 0-290° ø 60mm		

relés

relés de nivel

GICAR



1

código	403748	referencia	40800054
descripción	regulador de nivel 230V tensión AC 50/60Hz empalme conector Faston 6,3mm tipo RL30/2E-2C/F		

válvulas magnéticas

válvulas magnéticas agua

metal

SIRAI

válvulas magnéticas vapor (agua)

2 vías

serie L153-D



1

código	370326	referencia	30100066
descripción	válvula magnética 2vías 230VAC empalme 1" L 105mm DN 22mm conector hembra DIN -10 a 140°C SIRAI serie L153-D tipo de bobina Z914A membrana EPDM (vapor/agua) p máx. 8bar p mín. 0.1bar		
repuestos para	370326		
	código	371161	referencia —
	bobina magnética 230VAC 27VA SIRAI tipo de bobina Z923A soporte ø 16mm 50Hz		

fusibles





fusibles finos



1

código	358605	referencia	40200084
descripción	fusible fino medida ø5x20mm 3.15A retardado nominal 250V UE 10 pzs		
Para modelos:	KPI10ETA-GIGA, KPI10ET-GIGA, KPI15ETA-GIGA, KPI15ET-GIGA		

accesorios para		101893		
	código	101255	referencia	—
	anillo cortante para tuboø 12mm UE 1 pzs			
	código	101256	referencia	—
	anillo cortante para tuboø 16mm UE 1 pzs			
	código	101257	referencia	—
	anillo cortante para tuboø 20mm UE 1 pzs			
	código	101286	referencia	—
	anillo cortante int.ø 6mm UE 1 pzs			
	código	110080	referencia	—
	pomo ø 70mm eje ø 10x8mm parte plana universal			
	código	112206	referencia	—
	símbolo para pomo plata grifo de gas PEL21/22/23 T máx°C ø ext. 63mm int.ø 45.5mm			

accesorios para		101125		
	código	101390	referencia	—
	eje de grifo de gas eje ø 6x4,6mm eje L 32/15mm grifo de gas con llama piloto apto para ZANUSSI, MARENO para termostato de gas EUROSIT			
	código	101392	referencia	—
	adaptador apto para serie 630 Eurosit			
	código	110357	referencia	—
	eje de grifo de gas eje ø 8x6,5mm eje L 36/12mm apto para serie 630 Eurosit			
	código	110358	referencia	—
	adaptador eje ø 10x8mm eje L 29/18mm apto para serie 630 Eurosit			

válvulas de gas y centralitas de gas automáticas





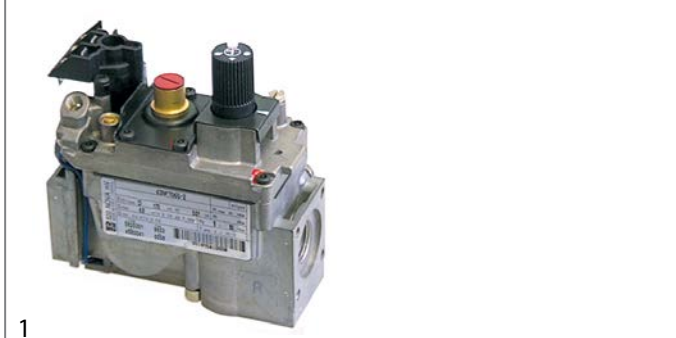

válvulas de control de gas

SIT

NOVASIT



1

código		101187	referencia	30100014
descripción	válvula de gas SIT serie Novasit 820 aliment. 0.17VHz entrada gas 1/2" salida gas 1/2" conexión termopar M9x1 conexión de piloto M10x1 presión de encendidobar margen de presión 5-50mbar conexión del presostato ciego núm. Ref. 0.820.301 alimentación operador Millivolt			
repuestos para	101187			
	código	101065	referencia	—
	grupo magnético con cable L 44mm D1 ø 30mm D2 ø 20mm apto para NOVASIT			
accesorios para	101187			
	código	100110	referencia	30100000
	piloto de encendido SIT tipo serie 190 3 llamas boquilla ømm empalme de gasmm			
	código	101305	referencia	—
	empalme de gas recto 1/2" brida 45x45mm ELETTROSIT/V4400/4600/4605 para SIT/HONEYWELL dist. del agujero 36x36mm			
	código	101306	referencia	—
	empalme de gas acodado brida 45x45mm dist. del agujero 36x36mm 1/2" ELETTROSIT/V4400/4600/4605 atornillado con junta tórica para SIT/HONEYWELL			
	código	101307	referencia	—
	empalme de gas recto brida 45x45mm dist. del agujero 36x36mm 3/4" ELETTROSIT/V4400/4600/4605 atornillado con junta tórica para SIT/HONEYWELL			
	código	101308	referencia	—
	empalme de gas acodado brida 45x45mm dist. del agujero 36x36mm 3/4" ELETTROSIT/V4400/4600/4605 atornillado con junta tórica para SIT/HONEYWELL			





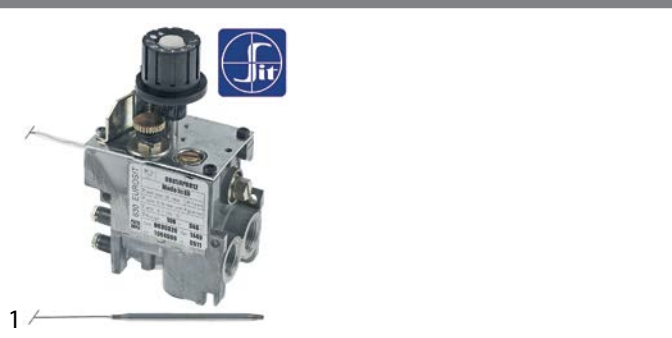

Continúa en la página siguiente

termostatos para gas

SIT

serie 630 Eurosit







código		101125	referencia	30100080
descripción	termostato de gas tipo serie 630 Eurosit T máx 340°C 100-340°C entrada gas 3/8" salida gas 3/8" conexión termopar M9x1 conexión de piloto M10x1 sonda ø 4mm sonda L 72mm capilar 1050mm SIT			
accesorios para	101125			
	código	100825	referencia	—
	eje de grifo de gas eje ø 8x6,5mm eje L 22/14mm apto para EUROSIT			
	código	100904	referencia	—
	tornillo de apriete M10x1 para tuboø 4mm UE 1 pzs			
	código	100905	referencia	—
	tornillo de apriete M10x1 para tuboø 6mm UE 1 pzs			
	código	100949	referencia	—
	junta apto para serie 630 Eurosit			
	código	101273	referencia	—
	anillo cortante para tuboø 12mm L 9.5mm latón UE 1 pzs apto para universal			
	código	101276	referencia	—
	tornillo de racor rosca 3/8" tubo ø 12mm UE 1 pzs			
	código	101333	referencia	—
	tapón rosca 3/8" con junta tórica			



accesorios para	101187
código	102116
referencia	40400130
termogenerador ROBERTSHAW L 900mm sonda ø 9mm sonda L 57mm 250-750mV unión roscada 7/16"	





código	107833	referencia	30100012	
descripción	válvula de gas SIT serie Novasit 826 aliment. 230V 50Hz entrada gas 1/2" salida gas 1/2" conexión de piloto cerrado margen de presión 2-50mbar conexión del presostato ciego núm. Ref. 0.826.010			
repuestos para	107833			
	código	101542	referencia	—
	bobina magnética 50Hz NOVA 822/826/827 apto para NOVASIT aliment. 230V			
accesorios para	107833			
	código	101305	referencia	—
	empalme de gas recto 1/2" brida 45x45mm ELETTROSIT/V4400/4600/4605 para SIT/HONEYWELL dist. del agujero 36x36mm			
	código	101306	referencia	—
	empalme de gas acodado brida 45x45mm dist. del agujero 36x36mm 1/2" ELETTROSIT/V4400/4600/4605 atornillado con junta tórica para SIT/HONEYWELL			
	código	101307	referencia	—
	empalme de gas recto brida 45x45mm dist. del agujero 36x36mm 3/4" ELETTROSIT/V4400/4600/4605 atornillado con junta tórica para SIT/HONEYWELL			
	código	101308	referencia	—
	empalme de gas acodado brida 45x45mm dist. del agujero 36x36mm 3/4" ELETTROSIT/V4400/4600/4605 atornillado con junta tórica para SIT/HONEYWELL			
	código	101859	referencia	—
	clavija semiempotrable con cable L 1000mm para rectificador apto para NOVASIT			

accesorios				
	1			
código	100110	referencia	30100000	
descripción	piloto de encendido SIT tipo serie 190 3 llamas boquilla ømm empalme de gasmm			
accesorios para	100110			
	código	100202	referencia	—
	boquilla de quemador piloto gas natural código 41 UE 1 pzs boquilla ø 0.41mm			
	código	100203	referencia	—
	boquilla de quemador piloto gas licuado código 25 UE 1 pzs boquilla ø 0.25mm			
	código	100701	referencia	—
	electrodo de encendido empalme M4 UE 1 pzs			

accesorios para	100110			
	código	100906	referencia	—
	unión roscada rosca M10x1 para electrodo de encendido latón UE 1 pzs EC 10			
	código	100907	referencia	—
	unión roscada rosca M10x1 UE 1 pzs tipo SEF 1 ømm para termopar			
	código	100908	referencia	—
	tornillo de racor rosca M10x1 para tuboø 4mm UE 1 pzs			
	código	100909	referencia	—
	tornillo de racor rosca M10x1 para tuboø 6mm UE 1 pzs			
	código	101282	referencia	—
	anillo cortante para tuboø 4mm L 7.4mm UE 1 pzs			
	código	101287	referencia	—
	anillo cortante para tuboø 6mm UE 1 pzs			
	código	102110	referencia	—
	tubo piloto cobre diámetro ø 4mm grosor de la pared 1mm L 3000mm			
	código	102111	referencia	—
	tubo piloto cobre diámetro ø 6mm grosor de la pared 1mm L 3000mm			
	código	107650	referencia	30500006
	boquilla de quemador piloto SIT gas licuado código 30 UE 1 pzs			

encendidos y temopares

pilotos de encendido

SIT				
serie 100				
	1			
código	106906	referencia	30100005	
descripción	piloto de encendido SIT tipo serie 100 3 llamas boquilla ø 0.2mm empalme de gas 6mm			
Para modelos:	KP20GA-GIGA, KP20G-GIGA, KP20GTA-GIGA, KP20GT-GIGA, KP30GA-GIGA, KP30G-GIGA, KP30GTA-GIGA, KP30GT-GIGA, KP50GA-GIGA, KP50G-GIGA, KP50GTA-GIGA, KP50GT-GIGA, KPGN18G-GIGA, KPGN27G-GIGA, KPGN37G-GIGA, KPI20GA-GIGA, KPI20G-GIGA, KPI20GTA-GIGA, KPI20GT-GIGA, KPI30GA-GIGA, KPI30G-GIGA, KPI30GTA-GIGA, KPI30GT-GIGA, KPI50GA-GIGA, KPI50G-GIGA, KPI50GTA-GIGA, KPI50GT-GIGA, KPIGN18G-GIGA, KPIGN27G-GIGA, KPIGN37G-GIGA, PM9.G170GN-FAGOR, PM9.G270GN-FAGOR, PM9.G370GN-FAGOR			
repuestos para	106906			
	código	100245	referencia	30500005
	boquilla de quemador piloto gas licuado código 20 taladro ø 0.2mm UE 1 pzs rosca M8x0,75			
	código	100855	referencia	—
	portapilotos triple			
	código	100885	referencia	—
	casquillo de mezcla de aire para quemador piloto UE 1 pzs			

Continúa en la página siguiente



repuestos para		106906	
	código	100916	referencia —
	resorte de compresión para quemador piloto UE 1 pzs		
	código	100917	referencia —
	junta para quemador piloto UE 1 pzs aluminio		
	código	100918	referencia —
	tornillo para quemador piloto		
	código	107162	referencia —
	parte superior de quemador piloto SIT 3 llamas Hmm Lmm UE 1 pzs		
	código	107701	referencia —
	parte inferior de quemador piloto SIT serie 100 boquilla ø 0.2mm		
accesorios para		106906	
	código	100245	referencia 30500005
	boquilla de quemador piloto gas licuado código 20 taladro ø 0.2mm UE 1 pzs rosca M8x0,75		
	código	100246	referencia —
	boquilla de quemador piloto gas natural taladro ø 0.35mm UE 1 pzs rosca M8x0,75		
	código	100904	referencia —
	tornillo de apriete M10x1 para tubo ø 4mm UE 1 pzs		
	código	100905	referencia —
	tornillo de apriete M10x1 para tubo ø 6mm UE 1 pzs		
	código	102110	referencia —
	tubo piloto cobre diámetro ø 4mm grosor de la pared 1mm L 3000mm		
	código	102111	referencia —
	tubo piloto cobre diámetro ø 6mm grosor de la pared 1mm L 3000mm		
	código	107171	referencia —
	boquilla de quemador piloto SIT gas natural/licuado taladro ø 0.25mm UE 1 pzs		
	código	107700	referencia —
	parte inferior de quemador piloto SIT serie 100 boquilla ø 0.25mm		
	código	107702	referencia —
	parte inferior de quemador piloto SIT serie 100 boquilla ø 0.35mm		

accesorios

boquillas piloto



código	100245	referencia	30500005
descripción	boquilla de quemador piloto gas licuado código 20 taladro ø 0.2mm UE 1 pzs rosca M8x0,75		

código	102972	referencia	30500003
descripción	boquilla de quemador piloto gas natural código 40 taladro ø 0.4mm UE 1 pzs		
Para modelos:	KP20GA-GIGA, KP20G-GIGA, KP20GTA-GIGA, KP20GT-GIGA, KP30GA-GIGA, KP30G-GIGA, KP30GTA-GIGA, KP30GT-GIGA, KP50GA-GIGA, KP50G-GIGA, KP50GTA-GIGA, KP50GT-GIGA, KPGN18G-GIGA, KPGN27G-GIGA, KPGN37G-GIGA, KPI20GA-GIGA, KPI20G-GIGA, KPI20GTA-GIGA, KPI20GT-GIGA, KPI30GA-GIGA, KPI30G-GIGA, KPI30GTA-GIGA, KPI30GT-GIGA, KPI50GA-GIGA, KPI50G-GIGA, KPI50GTA-GIGA, KPI50GT-GIGA, KPIGN18G-GIGA, KPIGN27G-GIGA, KPIGN37G-GIGA, PM9.G170GN-FAGOR, PM9.G270GN-FAGOR, PM9.G370GN-FAGOR		



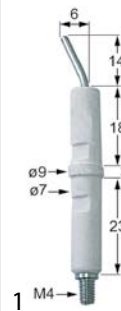

electródos de encendido



código	100706	referencia	30100054
descripción	electrodo de encendido empalme M4 UE 1 pzs		
Para modelos:	KP20GA-GIGA, KP20G-GIGA, KP20GTA-GIGA, KP20GT-GIGA, KP30GA-GIGA, KP30G-GIGA, KP30GTA-GIGA, KP30GT-GIGA, KP50GA-GIGA, KP50G-GIGA, KP50GTA-GIGA, KP50GT-GIGA, KPGN18G-GIGA, KPGN27G-GIGA, KPGN37G-GIGA, KPI20GA-GIGA, KPI20G-GIGA, KPI20GTA-GIGA, KPI20GT-GIGA, KPI30GA-GIGA, KPI30G-GIGA, KPI30GTA-GIGA, KPI30GT-GIGA, KPI50GA-GIGA, KPI50G-GIGA, KPI50GTA-GIGA, KPI50GT-GIGA, KPIGN18G-GIGA, KPIGN27G-GIGA, KPIGN37G-GIGA		

serie 190



código	100110	referencia	30100000
descripción	piloto de encendido SIT tipo serie 190 3 llamas boquilla ømm empalme de gasmm		
accesorios para		100110	
	código	100202	referencia —
	boquilla de quemador piloto gas natural código 41 UE 1 pzs boquilla ø 0.41mm		
	código	100203	referencia —
	boquilla de quemador piloto gas licuado código 25 UE 1 pzs boquilla ø 0.25mm		
	código	100701	referencia —
	electrodo de encendido empalme M4 UE 1 pzs		
	código	100906	referencia —
	unión roscada rosca M10x1 para electrodo de encendido latón UE 1 pzs EC 10		
	código	100907	referencia —
	unión roscada rosca M10x1 UE 1 pzs tipo SEF 1 ømm para temporar		

Continúa en la página siguiente

encendedores piezoeléctricos

diámetro de montaje 22mm

			
código	100013	referencia	40100130
descripción	encendedor piezoeléctrico cuerpo plástico soplado montaje ø 22mm empalme ø2,4mm longitud del cable mm		
Para modelos:	KP20GA-GIGA, KP20G-GIGA, KP20GTA-GIGA, KP20GT-GIGA, KP30GA-GIGA, KP30G-GIGA, KP30GTA-GIGA, KP30GT-GIGA, KP50GA-GIGA, KP50G-GIGA, KP50GTA-GIGA, KP50GT-GIGA, KPGN18G-GIGA, KPGN27G-GIGA, KPGN37G-GIGA, KPI20GA-GIGA, KPI20G-GIGA, KPI20GTA-GIGA, KPI20GT-GIGA, KPI30GA-GIGA, KPI30G-GIGA, KPI30GTA-GIGA, KPI30GT-GIGA, KPI50GA-GIGA, KPI50G-GIGA, KPI50GTA-GIGA, KPI50GT-GIGA, KPIGN18G-GIGA, KPIGN27G-GIGA, KPIGN37G-GIGA		
accesorios para	100013		
		código	100023
		referencia	—
	casquillo redondo tamaño 2.3mm 0,5-1,5mm ² CuZn T máx 125°C UE 20 pzs		

interruptores de encendido

			
código	345038	referencia	40100034
descripción	pulsador montaje ø 25mm negro 2NO 250V 16A empalme conector Faston 6,3mm temperatura ambiente máx. 85°C protección IP40		
Para modelos:	PM9.G170GN-FAGOR, PM9.G270GN-FAGOR, PM9.G370GN-FAGOR		

			
código	107783	referencia	40100132 40100132+10500092
descripción	interruptor de encendido para tipo de batería AA 1.5V montaje ø 22mm profundidad de montaje 68mm empalme F 2,8 distancia de sujeciónmm medidas 98x58x35mm salidas 1		

termopares

termopares insertables

termopares insertables estándar

con casquillo de enchufe ø6(6,5)mm

termopares SIT

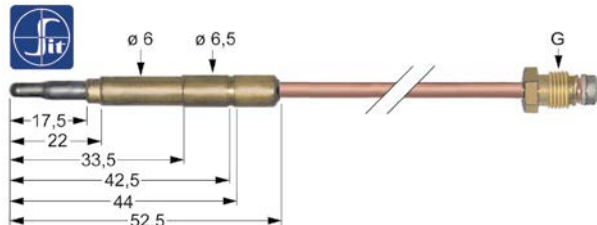
			
código	107612	referencia	40400100
descripción	termopar SIT M9x1 L 1000mm conexión para conector ø6,0(6,5)mm		
Para modelos:	KP20GA-GIGA, KP20G-GIGA, KP20GTA-GIGA, KP20GT-GIGA, KP30GA-GIGA, KP30G-GIGA, KP30GTA-GIGA, KP30GT-GIGA, KP50GA-GIGA, KP50G-GIGA, KP50GTA-GIGA, KP50GT-GIGA, KPGN18G-GIGA, KPGN27G-GIGA, KPGN37G-GIGA, KPI20GA-GIGA, KPI20G-GIGA, KPI20GTA-GIGA, KPI20GT-GIGA, KPI30GA-GIGA, KPI30G-GIGA, KPI30GTA-GIGA, KPI30GT-GIGA, KPI50GA-GIGA, KPI50G-GIGA, KPI50GTA-GIGA, KPI50GT-GIGA, KPIGN18G-GIGA, KPIGN27G-GIGA, KPIGN37G-GIGA, PM9.G170GN-FAGOR, PM9.G270GN-FAGOR, PM9.G370GN-FAGOR		

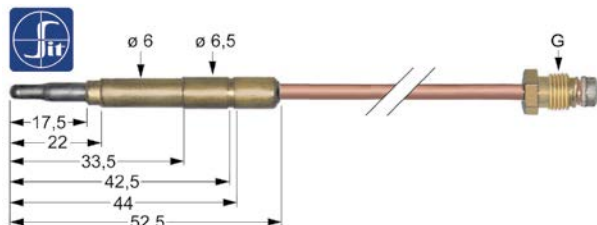
			
código	107611	referencia	40400110
descripción	termopar SIT M9x1 L 850mm conexión para conector ø6,0(6,5)mm		

termogeneradores

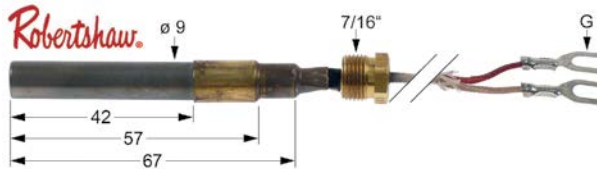
			
código	102116	referencia	40400130
descripción	termogenerador ROBERTSHAW L 900mm sonda ø 9mm sonda L 57mm 250-750mV unión roscada 7/16"		





quemadores de gas

quemadores tubulares

quemadores tubulares

			
1			
código	105481	referencia	30400060
descripción	quemador tubular ø 40mm Anmm Hmm L 325mm brida ø 61mm sartén basculante		

			
1			
código	105482	referencia	30400050
descripción	quemador tubular ø 40mm Anmm Hmm L 396mm brida ø 61mm sartén basculante		

			
1			
código	105257	referencia	30400050 old version
descripción	quemador tubular ø 40mm Anmm Hmm L 397mm marmita brida ø 61mm distancia de sujeción 45mm		

boquillas de gas

boquillas piloto

boquillas piloto SIT

serie 100

			
1			
código	100245	referencia	30500005
descripción	boquilla de quemador piloto gas licuado código 20 taladro ø 0.2mm UE 1 pzs rosca M8x0,75		

			
1			
código	102972	referencia	30500003
descripción	boquilla de quemador piloto gas natural código 40 taladro ø 0.4mm UE 1 pzs		
Para modelos:	KP20GA-GIGA, KP20G-GIGA, KP20GTA-GIGA, KP20GT-GIGA, KP30GA-GIGA, KP30G-GIGA, KP30GTA-GIGA, KP30GT-GIGA, KP50GA-GIGA, KP50G-GIGA, KP50GTA-GIGA, KP50GT-GIGA, KPGN18G-GIGA, KPGN27G-GIGA, KPGN37G-GIGA, KPI20GA-GIGA, KPI20G-GIGA, KPI20GTA-GIGA, KPI20GT-GIGA, KPI30GA-GIGA, KPI30G-GIGA, KPI30GTA-GIGA, KPI30GT-GIGA, KPI50GA-GIGA, KPI50G-GIGA, KPI50GTA-GIGA, KPI50GT-GIGA, KPIGN18G-GIGA, KPIGN27G-GIGA, KPIGN37G-GIGA, PM9.G170GN-FAGOR, PM9.G270GN-FAGOR, PM9.G370GN-FAGOR		

serie 160

			
1			
código	107650	referencia	30500006
descripción	boquilla de quemador piloto SIT gas licuado código 30 UE 1 pzs		

			
1			
código	107175	referencia	30500007
descripción	boquilla de quemador piloto SIT gas natural código 51 UE 1 pzs para serie 160		

componentes específicos

para amasadoras

cajinetes brida

			
1			
código	693112	referencia	20400012
descripción	coinete de brida tipo UCF204 árbol ø 20mm brida 4 orificios dist. del agujero 64mm H 33mm longitud brida 86mm anchura brida 86mm agujero ø 12mm brida F204 rodamiento de bolas UC204G2 altura brida 25.5mm		

para sartén basculante

tornillos sin fin

			
1			
código	693110	referencia	SMB012800 SMB129-00
descripción	barra roscada L 363mm ø 20mm		

otros

			
1			
código	693111	referencia	SMB013000
descripción	árbol		

1 

código	693114	referencia	SMB063000
descripción	árbol		

1 

código	693109	referencia	SC02200 SC02200+10300042
descripción	casquillo roscado para sartén basculante latón rosca TR20x4		

para marmitas

filtros

1 

código	514503	referencia	30700122 FX30700122
descripción	filtro de desagüe para marmita tamaño 76x145mm		
Para modelos:	KPI10ETA-GIGA, KPI10ET-GIGA, KPI10VTA-GIGA, KPI10VT-GIGA, KPI15ETA-GIGA, KPI15ET-GIGA, KPI15VTA-GIGA, KPI15VT-GIGA, PM9.G170GN-FAGOR, PM9.G270GN-FAGOR, PM9.G370GN-FAGOR		

otros

1 

código	540639	referencia	10400058
descripción	extensión		
Para modelos:	KPI10VTA-GIGA, KPI10VT-GIGA, KPI15VTA-GIGA, KPI15VT-GIGA, KPI20VTA-GIGA, KPI20VT-GIGA, KPI30VTA-GIGA, KPI30VT-GIGA, KPI50VTA-GIGA, KPI50VT-GIGA		

pomos

pomos personalizados para fabricantes

FIREX

1 

código	112571	referencia	20200001
descripción	pomo grifo de gas con llama piloto ø 65mm eje ø 10x8mm parte plana abajo		
Para modelos:	KP20GA-GIGA, KP20G-GIGA, KP20GTA-GIGA, KP20GT-GIGA, KP30GA-GIGA, KP30G-GIGA, KP30GTA-GIGA, KP30GT-GIGA, KP50GA-GIGA, KP50G-GIGA, KP50GTA-GIGA, KP50GT-GIGA, KPGN18G-GIGA, KPGN27G-GIGA, KPGN37G-GIGA, KPI20GA-GIGA, KPI20G-GIGA, KPI20GTA-GIGA, KPI20GT-GIGA, KPI30GA-GIGA, KPI30G-GIGA, KPI30GTA-GIGA, KPI30GT-GIGA, KPI50GA-GIGA, KPI50G-GIGA, KPI50GTA-GIGA, KPI50GT-GIGA, KPIGN18G-GIGA, KPIGN27G-GIGA, KPIGN37G-GIGA, PM9.G170GN-FAGOR, PM9.G270GN-FAGOR, PM9.G370GN-FAGOR		

manillas y volantes

volantes

1 

código	692443	referencia	SMB013600
descripción	volante ø 150mm D1 ø 38mm taladro ø 14mm rosca ancho de ranura 6mm profundidad de ranura 13mm distancia de sujeción 18mm L1 40mm L2 43mm longitud de asidero 65mm con asidero abatible		

1 

código	692430	referencia	SMB063600
descripción	volante ø 200mm D1 ø 50mm taladro ø 20mm rosca ancho de ranura 6mm profundidad de ranura 13mm distancia de sujeción 30mm L1 47mm L2 50mm longitud de asidero 90mm con asidero abatible		



pomos

			
1			
código	540323	referencia	20200013
descripción	pomo esférico rosca M10 ø 40mm con casquillo metálico negro		
Para modelos:	KPI10ETA-GIGA, KPI10ET-GIGA, KPI15ETA-GIGA, KPI15ET-GIGA, KPI20ETA-GIGA, KPI20ET-GIGA, KPI20VTA-GIGA, KPI20VT-GIGA, KPI30ETA-GIGA, KPI30ET-GIGA, KPI30VTA-GIGA, KPI30VT-GIGA, KPI50ETA-GIGA, KPI50ET-GIGA, KPI50VTA-GIGA, KPI50VT-GIGA		

grifería para cocinas industriales

bisagras de tapa

tipo RUBINETTERIE DEL FRIULI

para tapa redonda

piezas de repuesto

			
1			
código	540854	referencia	20500044
descripción	resorte de torsión ø 50.8mm espesor de hilo 5.1mm L1 34mm L2 104mm L3 29mm pos. de montaje derecho		

			
1			
código	540855	referencia	20500046
descripción	resorte de torsión ø 50.8mm espesor de hilo 5.1mm L1 34mm L2 104mm L3 29mm pos. de montaje izquierdo		

FIREX



bisagras de tapa

			
1			
código	514412	referencia	20300096
descripción	bisagra de tapa L 230mm distancia de sujeción 1 150mm radio de brida 320mm espesor de resorte 4mm para tapa redonda		
Para modelos:	KPI10ETA-GIGA, KPI10ET-GIGA, KPI10VTA-GIGA, KPI10VT-GIGA, KPI15ETA-GIGA, KPI15ET-GIGA, KPI15VTA-GIGA, KPI15VT-GIGA		
repuestos para	514412		
	código	540846	referencia
			—
		resorte de torsión ø 42.5mm espesor de hilo 4.1mm L1 93mm L2 26mm L3 26mm pos. de montaje izquierdo	

repuestos para	514412		
	código	540847	referencia
			—
	resorte de torsión ø 42.5mm espesor de hilo 4.1mm L1 93mm L2 26mm L3 26mm pos. de montaje derecho		



			
1			
código	514413	referencia	20300086
descripción	bisagra de tapa L 270mm distancia de sujeción 1 139mm radio de brida 395mm espesor de resorte 5mm taladro ø M15mm para tapa redonda		
Para modelos:	KP20GA-GIGA, KP20G-GIGA, KP20GTA-GIGA, KP20GT-GIGA, KP30GA-GIGA, KP30G-GIGA, KP30GTA-GIGA, KP30GT-GIGA, KP50GA-GIGA, KP50G-GIGA, KP50GTA-GIGA, KP50GT-GIGA, KPI20EA-GIGA, KPI20E-GIGA, KPI20ET-GIGA, KPI20GA-GIGA, KPI20G-GIGA, KPI20GTA-GIGA, KPI20GT-GIGA, KPI20VTA-GIGA, KPI20VT-GIGA, KPI30EA-GIGA, KPI30E-GIGA, KPI30GA-GIGA, KPI30G-GIGA, KPI30GTA-GIGA, KPI30GT-GIGA, KPI50EA-GIGA, KPI50E-GIGA, KPI50GA-GIGA, KPI50G-GIGA, KPI50GTA-GIGA, KPI50GT-GIGA		

código	514413	referencia	20300086
descripción	bisagra de tapa L 270mm distancia de sujeción 1 139mm radio de brida 395mm espesor de resorte 5mm taladro ø M15mm para tapa redonda		
Para modelos:	KP20GA-GIGA, KP20G-GIGA, KP20GTA-GIGA, KP20GT-GIGA, KP30GA-GIGA, KP30G-GIGA, KP30GTA-GIGA, KP30GT-GIGA, KP50GA-GIGA, KP50G-GIGA, KP50GTA-GIGA, KP50GT-GIGA, KPI20EA-GIGA, KPI20E-GIGA, KPI20ET-GIGA, KPI20GA-GIGA, KPI20G-GIGA, KPI20GTA-GIGA, KPI20GT-GIGA, KPI20VTA-GIGA, KPI20VT-GIGA, KPI30EA-GIGA, KPI30E-GIGA, KPI30GA-GIGA, KPI30G-GIGA, KPI30GTA-GIGA, KPI30GT-GIGA, KPI50EA-GIGA, KPI50E-GIGA, KPI50GA-GIGA, KPI50G-GIGA, KPI50GTA-GIGA, KPI50GT-GIGA		

repuestos para	514413		
	código	540854	referencia
			20500044
	resorte de torsión ø 50.8mm espesor de hilo 5.1mm L1 34mm L2 104mm L3 29mm pos. de montaje derecho		
	código	540855	referencia
			20500046
	resorte de torsión ø 50.8mm espesor de hilo 5.1mm L1 34mm L2 104mm L3 29mm pos. de montaje izquierdo		

			
1			
código	514414	referencia	20300108
descripción	bisagra de tapa L 270mm distancia de sujeción 1 139mm radio de brida 470mm espesor de resorte 6mm taladro ø M15mm para tapa redonda		
Para modelos:	KPI30ET-GIGA, KPI30VTA-GIGA, KPI30VT-GIGA, KPI50ET-GIGA, KPI50VTA-GIGA, KPI50VT-GIGA		

código	514414	referencia	20300108
descripción	bisagra de tapa L 270mm distancia de sujeción 1 139mm radio de brida 470mm espesor de resorte 6mm taladro ø M15mm para tapa redonda		
Para modelos:	KPI30ET-GIGA, KPI30VTA-GIGA, KPI30VT-GIGA, KPI50ET-GIGA, KPI50VTA-GIGA, KPI50VT-GIGA		

repuestos para	514414		
	código	540856	referencia
			—
	resorte de torsión ø 52mm espesor de hilo 6.2mm L1 30mm L2 95mm L3 30mm pos. de montaje derecho		
	código	540857	referencia
			—
	resorte de torsión ø 52mm espesor de hilo 6.2mm L1 30mm L2 95mm L3 30mm pos. de montaje izquierdo		

piezas de repuesto



código	540854	referencia	20500044
descripción	resorte de torsión ø 50.8mm espesor de hilo 5.1mm L1 34mm L2 104mm L3 29mm pos. de montaje derecho		



código	540855	referencia	20500046
descripción	resorte de torsión ø 50.8mm espesor de hilo 5.1mm L1 34mm L2 104mm L3 29mm pos. de montaje izquierdo		

ICOS



código	540854	referencia	20500044
descripción	resorte de torsión ø 50.8mm espesor de hilo 5.1mm L1 34mm L2 104mm L3 29mm pos. de montaje derecho		



código	540855	referencia	20500046
descripción	resorte de torsión ø 50.8mm espesor de hilo 5.1mm L1 34mm L2 104mm L3 29mm pos. de montaje izquierdo		

cierres de tapa

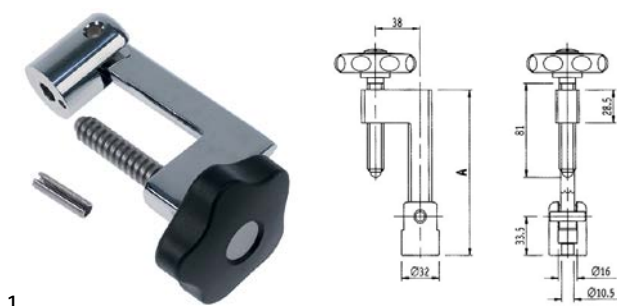

código	514127	referencia	20300093
descripción	cierre de tapa asidero ø 70mm L 143mm		
Para modelos:	KP20GA-GIGA, KP20GTA-GIGA, KP30GA-GIGA, KP30GTA-GIGA, KP50GA-GIGA, KP50GTA-GIGA, KPI10ETA-GIGA, KPI10VTA-GIGA, KPI15ETA-GIGA, KPI15VTA-GIGA, KPI20EA-GIGA, KPI20ETA-GIGA, KPI20GA-GIGA, KPI20GTA-GIGA, KPI20VTA-GIGA, KPI20VT-GIGA, KPI30EA-GIGA, KPI30ETA-GIGA, KPI30GA-GIGA, KPI30GTA-GIGA, KPI30VTA-GIGA, KPI30VT-GIGA, KPI50EA-GIGA, KPI50ETA-GIGA, KPI50GA-GIGA, KPI50GTA-GIGA, KPI50VTA-GIGA, KPI50VT-GIGA		

grifos de carga



código	693108	referencia	30200005
descripción	válvula de cierre		

grifos de vaciado

latón

grifos de vaciado



código	540275	referencia	30200198
descripción	grifo de vaciado 2" H con tuerca de racor A 90mm B 151mm B1 80mm latón cromado		
Para modelos:	KP20GA-GIGA, KP20G-GIGA, KP20GTA-GIGA, KP20GT-GIGA, KP30GA-GIGA, KP30G-GIGA, KP30GTA-GIGA, KP30GT-GIGA, KP50GA-GIGA, KP50G-GIGA, KP50GTA-GIGA, KP50GT-GIGA, KPGN18G-GIGA, KPGN27G-GIGA, KPGN37G-GIGA, KPI10ETA-GIGA, KPI10ET-GIGA, KPI10VTA-GIGA, KPI10VT-GIGA, KPI15ETA-GIGA, KPI15ET-GIGA, KPI15VTA-GIGA, KPI15VT-GIGA, KPI20EA-GIGA, KPI20E-GIGA, KPI20ETA-GIGA, KPI20ET-GIGA, KPI20GA-GIGA, KPI20G-GIGA, KPI20GTA-GIGA, KPI20GT-GIGA, KPI20VTA-GIGA, KPI20VT-GIGA, KPI30EA-GIGA, KPI30E-GIGA, KPI30ETA-GIGA, KPI30ET-GIGA, KPI30GA-GIGA, KPI30G-GIGA, KPI30GTA-GIGA, KPI30GT-GIGA, KPI30VTA-GIGA, KPI30VT-GIGA, KPI50EA-GIGA, KPI50E-GIGA, KPI50ETA-GIGA, KPI50ET-GIGA, KPI50GA-GIGA, KPI50G-GIGA, KPI50GTA-GIGA...(Otros modelos se puede ver en la tienda web)		

repuestos para	540275	código	540214	referencia	—
			manilla int.ø 6mm L 145mm		
accesorios para	540275	código	529484	referencia	—
			junta plana fibra ø ext. 58mm int.ø 50mm espesor 2mm UE 1 pzs		
		código	542448	referencia	—
			junta silicona 60x49x2 para grifo de vaciado 2"		



accesorios



código	540954	referencia	10400009
descripción	empalme enroscable para grifo de vaciado rosca 1½"		



código	540957	referencia	10400006
descripción	empalme enroscable para grifo de vaciado rosca 2" L 120mm		
Para modelos:	KPI10VTA-GIGA, KPI10VT-GIGA, KPI15VTA-GIGA, KPI15VT-GIGA		



código	540956	referencia	10500062
descripción	junta para grifo de vaciado ø tubo 46mm int.ø 38mm H 2mm		



código	540959	referencia	10500060
descripción	junta para grifo de vaciado ø tubo 60mm int.ø 50mm H 2mm		
Para modelos:	KP20GA-GIGA, KP20G-GIGA, KP20GTA-GIGA, KP20GT-GIGA, KP30GA-GIGA, KP30G-GIGA, KP30GTA-GIGA, KP30GT-GIGA, KP50GA-GIGA, KP50G-GIGA, KP50GTA-GIGA, KP50GT-GIGA, KPGN18G-GIGA, KPGN27G-GIGA, KPGN37G-GIGA, KPI10ETA-GIGA, KPI10ET-GIGA, KPI10VTA-GIGA, KPI10VT-GIGA, KPI15ETA-GIGA, KPI15ET-GIGA, KPI15VTA-GIGA, KPI15VT-GIGA, KPI20EA-GIGA, KPI20E-GIGA, KPI20ETA-GIGA, KPI20ET-GIGA, KPI20GA-GIGA, KPI20G-GIGA, KPI20GTA-GIGA, KPI20GT-GIGA, KPI20VTA-GIGA, KPI20VT-GIGA, KPI20VTA-GIGA, KPI20VT-GIGA, KPI30EA-GIGA, KPI30E-GIGA, KPI30ETA-GIGA, KPI30ET-GIGA, KPI30GA-GIGA, KPI30G-GIGA, KPI30GTA-GIGA, KPI30GT-GIGA, KPI30VTA-GIGA, KPI30VT-GIGA, KPI50EA-GIGA, KPI50E-GIGA, KPI50ETA-GIGA, KPI50ET-GIGA, KPI50GA-GIGA, KPI50G-GIGA, KPI50GTA-GIGA...(Otros modelos se puede ver en la tienda web)		



código	540958	referencia	10200002
descripción	roseta para grifo de vaciado ø tubo 120mm int.ø 60mm H 13mm		
Para modelos:	KP20GA-GIGA, KP20G-GIGA, KP20GTA-GIGA, KP20GT-GIGA, KP30GA-GIGA, KP30G-GIGA, KP30GTA-GIGA, KP30GT-GIGA, KP50GA-GIGA, KP50G-GIGA, KP50GTA-GIGA, KP50GT-GIGA, KPGN18G-GIGA, KPGN27G-GIGA, KPGN37G-GIGA, KPI10ETA-GIGA, KPI10ET-GIGA, KPI10VTA-GIGA, KPI10VT-GIGA, KPI15ETA-GIGA, KPI15ET-GIGA, KPI15VTA-GIGA, KPI15VT-GIGA, KPI20EA-GIGA, KPI20E-GIGA, KPI20ETA-GIGA, KPI20ET-GIGA, KPI20GA-GIGA, KPI20G-GIGA, KPI20GTA-GIGA, KPI20GT-GIGA, KPI20VTA-GIGA, KPI20VT-GIGA, KPI30EA-GIGA, KPI30E-GIGA, KPI30ETA-GIGA, KPI30ET-GIGA, KPI30GA-GIGA, KPI30G-GIGA, KPI30GTA-GIGA, KPI30GT-GIGA, KPI30VTA-GIGA, KPI30VT-GIGA, KPI50EA-GIGA, KPI50E-GIGA, KPI50ETA-GIGA, KPI50ET-GIGA, KPI50GA-GIGA, KPI50G-GIGA, KPI50GTA-GIGA...(Otros modelos se puede ver en la tienda web)		



código	540955	referencia	10200004
descripción	roseta para grifo de vaciado rosca 1½"		

grifos de seguridad

accesorios



código	540835	referencia	10400061
descripción	tapa roscada rosca 3/4"		
Para modelos:	KP20GTA-GIGA, KP20GT-GIGA, KP30GTA-GIGA, KP30GT-GIGA, KP50GTA-GIGA, KP50GT-GIGA, KPI10ETA-GIGA, KPI10ET-GIGA, KPI15ETA-GIGA, KPI15ET-GIGA, KPI20EA-GIGA, KPI20E-GIGA, KPI20ETA-GIGA, KPI20ET-GIGA, KPI20GA-GIGA, KPI20G-GIGA, KPI20GTA-GIGA, KPI20GT-GIGA, KPI30EA-GIGA, KPI30E-GIGA, KPI30ETA-GIGA, KPI30ET-GIGA, KPI30GA-GIGA, KPI30G-GIGA, KPI30GTA-GIGA, KPI30GT-GIGA, KPI50ET-GIGA, KPI50GA-GIGA, KPI50G-GIGA, KPI50GTA-GIGA, KPI50GT-GIGA, KPIGN37G-GIGA, PM9.G170GN-FAGOR, PM9.G270GN-FAGOR, PM9.G370GN-FAGOR		

repuestos para	540835	código	513016	referencia	—
	junta tórica EPDM espesor 3.53mm int.ø 26.58mm UE 1 pzs				

accesorios para	540835	código	513016	referencia	—
	junta tórica EPDM espesor 3.53mm int.ø 26.58mm UE 1 pzs				

válvulas de seguridad



1

código	540722	referencia	30300026
descripción	válvula de seguridad con salida para tapa		
Para modelos:	KPI10ETA-GIGA, KPI15ETA-GIGA, KPI20ETA-GIGA, KPI30ETA-GIGA, KPI50ETA-GIGA		



1

código	514415	referencia	30300018 30300024 30300026
descripción	válvula de seguridad para marmita rosca M33		
Para modelos:	KP20GA-GIGA, KP20GTA-GIGA, KP30GA-GIGA, KP30GTA-GIGA, KP50GA-GIGA, KP50GTA-GIGA, KPI10VTA-GIGA, KPI15VTA-GIGA, KPI20EA-GIGA, KPI20GA-GIGA, KPI20GTA-GIGA, KPI20VTA-GIGA, KPI20VT-GIGA, KPI30EA-GIGA, KPI30GA-GIGA, KPI30GTA-GIGA, KPI30VTA-GIGA, KPI30VT-GIGA, KPI50EA-GIGA, KPI50GA-GIGA, KPI50GTA-GIGA, KPI50VTA-GIGA, KPI50VT-GIGA		

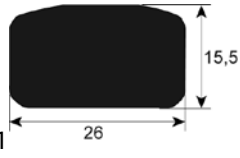

código	900822	referencia	10600300/2
descripción	junta de marmita perfil 3010 L 2400mm		
Para modelos:	KPI20ETA-GIGA, KPI20VTA-GIGA		

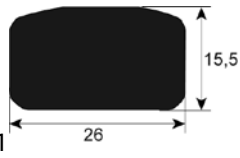

código	900823	referencia	10600300/3
descripción	junta de marmita perfil 3010 L 3000mm		
Para modelos:	KPI30ETA-GIGA, KPI30VTA-GIGA, KPI50ETA-GIGA, KPI50VTA-GIGA		

juntas tóricas

EPDM

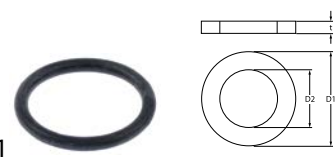

1

código	511937	referencia	10500110
descripción	junta tórica EPDM espesor 3.53mm int.ø 28.17mm UE 1 pzs		
Para modelos:	KP20GTA-GIGA, KP20GT-GIGA, KP30GTA-GIGA, KP30GT-GIGA, KP50GTA-GIGA, KP50GT-GIGA, KPI10ETA-GIGA, KPI10ET-GIGA, KPI15ETA-GIGA, KPI15ET-GIGA, KPI20EA-GIGA, KPI20E-GIGA, KPI20ETA-GIGA, KPI20ET-GIGA, KPI20GA-GIGA, KPI20G-GIGA, KPI20GTA-GIGA, KPI20GT-GIGA, KPI30EA-GIGA, KPI30E-GIGA, KPI30ETA-GIGA, KPI30ET-GIGA, KPI30GA-GIGA, KPI30G-GIGA, KPI30GTA-GIGA, KPI30GT-GIGA, KPI50EA-GIGA, KPI50E-GIGA, KPI50ETA-GIGA, KPI50ET-GIGA, KPI50GA-GIGA, KPI50G-GIGA, KPI50GTA-GIGA, KPI50GT-GIGA, KPIGN37G-GIGA, PM9.G170GN-FAGOR, PM9.G270GN-FAGOR, PM9.G370GN-FAGOR		

juntas

juntas térmicas

juntas para marmitas

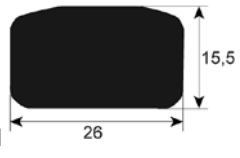

1

código	900819	referencia	10600300
descripción	junta de marmita perfil 3010 L 1000mm		
Para modelos:	KP20GA-GIGA, KP20GTA-GIGA, KP30GA-GIGA, KP30GTA-GIGA, KP50GA-GIGA, KP50GTA-GIGA, KPI10ETA-GIGA, KPI10VTA-GIGA, KPI15ETA-GIGA, KPI15VTA-GIGA, KPI20EA-GIGA, KPI20GA-GIGA, KPI20GTA-GIGA, KPI30EA-GIGA, KPI30GA-GIGA, KPI30GTA-GIGA, KPI50EA-GIGA, KPI50GA-GIGA, KPI50GTA-GIGA		

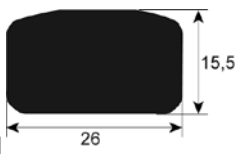

1

código	900821	referencia	10600300/1
descripción	junta de marmita perfil 3010 L 2000mm		
Para modelos:	KPI10ETA-GIGA, KPI10VTA-GIGA, KPI15ETA-GIGA, KPI15VTA-GIGA		

técnica de accionamiento y rodamientos de bolas

rodamientos de bolas

cajinetes brida



1

código	693112	referencia	20400012
descripción	coinete de brida tipo UCF204 árbol ø 20mm brida 4 orificios dist. del agujero 64mm H 33mm longitud brida 86mm anchura brida 86mm agujero ø 12mm brida F204 rodamiento de bolas UC204G2 altura brida 25.5mm		



muelles

muelles de torsión

			
código	540854	referencia	20500044
descripción	resorte de torsión ø 50.8mm espesor de hilo 5.1mm L1 34mm L2 104mm L3 29mm pos. de montaje derecho		

			
código	540855	referencia	20500046
descripción	resorte de torsión ø 50.8mm espesor de hilo 5.1mm L1 34mm L2 104mm L3 29mm pos. de montaje izquierdo		

resortes de gas

resortes de gas

			
código	698322	referencia	20300270
descripción	resorte de gas 882.5N elevación 100mm D1 ø 22mm D2 ø 10mm dist. del agujero 300mm agujero ø 8/10mm L 315mm		

manómetros

				
código	541062	referencia	30300022	
descripción	manómetro ø 63mm margen de presión 0 a 1bar empalme marca ajustable marmita rosca 1/4"			
Para modelos:	KP20GTA-GIGA, KP20GT-GIGA, KP30GTA-GIGA, KP30GT-GIGA, KP50GTA-GIGA, KP50GT-GIGA, KPI10ETA-GIGA, KPI10ET-GIGA, KPI10VTA-GIGA, KPI10VT-GIGA, KPI15ETA-GIGA, KPI15ET-GIGA, KPI15VTA-GIGA, KPI15VT-GIGA, KPI20EA-GIGA, KPI20E-GIGA, KPI20ETA-GIGA, KPI20ET-GIGA, KPI20GA-GIGA, KPI20G-GIGA, KPI20GTA-GIGA, KPI20GT-GIGA, KPI20VTA-GIGA, KPI20VT-GIGA, KPI30EA-GIGA, KPI30E-GIGA, KPI30ETA-GIGA, KPI30ET-GIGA, KPI30GA-GIGA, KPI30G-GIGA, KPI30GTA-GIGA, KPI30GT-GIGA, KPI30VTA-GIGA, KPI30VT-GIGA, KPI50EA-GIGA, KPI50E-GIGA, KPI50ETA-GIGA, KPI50ET-GIGA, KPI50GA-GIGA, KPI50G-GIGA, KPI50GTA-GIGA, KPI50GT-GIGA, KPI50VTA-GIGA, KPI50VT-GIGA, KPIGN37G-GIGA, PM9.G170GN-FAGOR, PM9.G270GN-FAGOR, PM9.G370GN-FAGOR			
repuestos para	541062			
	código	541130	referencia	—
	 vidrio ø 58mm espesor 2mm			

válvulas y caños de pared

válvulas de cierre

universal

				
código	693107	referencia	30200008	
descripción	válvula de cierre empalme 1/2" 1/2" frío longitud 54mm L1 27mm L2 30mm marca azul rosca de roseta G2 26x19G ø empalme M4x0,7 Fmm			
repuestos para	693107			
	código	514085	referencia	—
	 roseta empalme 26x19G cromado longitudmm pos. de montaje			
	código	514086	referencia	—
	 tuerca hexagonal empalme 26x19G latón longitudmm pos. de montaje H 6mm EC 34 UE 1 pzs			
	código	540672	referencia	—
	 junta apto para montura			
	código	547711	referencia	—
	 manilla de campana soporte de eje ø 8mm marca azul metal H2 21mm D1 ø 33mm tipo D apto para MONOLITH longitud eje H1 8mm			
	código	548168	referencia	—
	 manilla en forma de estrella empalme caliente longitudmm pos. de montaje ø 57mm marca rojo			
	código	548169	referencia	—
	 manilla en forma de estrella empalme frío longitudmm pos. de montaje cromado ø 57mm			
accesorios para	693107			
	código	514086	referencia	—
	 tuerca hexagonal empalme 26x19G latón longitudmm pos. de montaje H 6mm EC 34 UE 1 pzs			

consumibles

fusibles

fusibles finos

			
código	358605	referencia	40200084
descripción	fusible fino medida ø5x20mm 3.15A retardado nominal 250V UE 10 pzs		
Para modelos:	KPI10ETA-GIGA, KPI10ET-GIGA, KPI15ETA-GIGA, KPI15ET-GIGA		

B			
boquillas de gas	13		
C			
conmutadores de levas	5		
consumibles	19		
E			
encendedores piezoeléctricos	12		
F			
fusibles	6, 19		
fusibles finos	19		
G			
grifos de gas	7		
I			
interruptores de encendido	12		
interruptores pulsantes y pulsadores	5		
interruptores y pulsadores	5		
J			
juntas para marmitas	18		
juntas térmicas	18		
juntas tóricas	18		
L			
lámparas	5		
lámparas de señalización	5		
lámparas de señalización completas	6		
M			
microinterruptores	5		
P			
pilotos de encendido	9		
Q			
quemadores de gas	13		
quemadores tubulares	13		
R			
relés	6		
resistencias	3		
resistencias de inmersión	3		
resistencias para sartenes basculantes	3		
T			
temporizadores	6		
temporizadores mecánicos	6		
termopares	12		
		termostatos	4
		termostatos de regulación	4
		termostatos de seguridad	4
		termostatos para gas	8
		V	
		válvulas de cierre	19
		válvulas de control de gas	8
		válvulas magnéticas	6
		válvulas y caños de pared	19