



COMPONENTES GAS



COMPONENTES ELÉCTRICOS



TECNOLOGÍA DEL AGUA



COMPONENTES MECÁNICOS



HERRAMIENTAS

Repuestos adaptables a

ANGELO-PO

Encuentre nuestra gama siempre actualizada en la tienda online de GEV



Catálogo de fabricantes

Las piezas de repuesto y accesorios más importantes de cada fabricante reunidas y ordenadas de manera práctica

- ✓ En la tienda online GEV encontrará el surtido completo y toda la información actualizada de máquinas y aparatos
- ✓ Índice alfabético al final del catálogo

Tienda online GEV

www.gev-online.es
www.gev-online.com



- 🔍 marcar artículos como favoritos
- 🔍 acceso mediante su e-mail y su contraseña habitual
- 🔍 ponga en la cesta de la compra, múltiples artículos a la vez
- 🔍 búsqueda de artículos inmediata sin necesidad conectarse

resistencias

resistencias para hornos

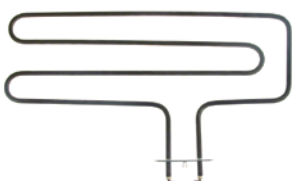

1

código	418596	referencia	32G1590 32G1591
descripción	resistencia 2600W 230V L 265mm An 510mm L1 93mm B2 62mm longitud brida 100mm anchura brida 22mm dist. del agujero 86mm agujero ø 5mm		
Para modelos:	1G1FA0E, 1G1FA0EV, 1G1PE1E, 1G1PE1EV, 1G1PE2E, 1G1PE2EV, 2G1PE1E, 2G1PE1EV, 2G1PE2E, 2G1PE2EV, 31GE, 31TCE, 32TCE		

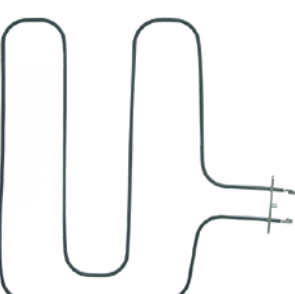

1

código	416677	referencia	32G0151 32G1350 32G1351
descripción	resistencia 2600W 400V L 460mm An 505mm L1 115mm L2 340mm B1 150mm B2 60mm longitud brida 100mm anchura brida 22mm dist. del agujero 86mm agujero ø 5mm tubo ø 6.3mm empalme conector Faston 6,3mm espirales 1 brida rectangular horno		
Para modelos:	31GE, 31TCE, 32TCE		

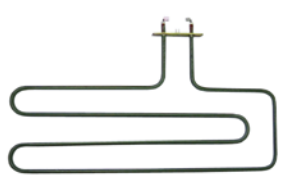

1

código	415673	referencia	32G1621 32G1630
descripción	resistencia 2600W 415V L 251mm An 510mm L1 89mm L2 162mm B1 287mm B2 63mm longitud brida 100mm anchura brida 22mm dist. del agujero 86mm agujero ø 5mm tubo ø 8.7mm longitud de empalme 31mm empalme conector Faston 6,3mm espirales 1 brida rectangular resistencia seca horno		
Para modelos:	1G1FA0E, 1G1FA0EV, 1G1PE1E, 1G1PE1EV, 1G1PE2E, 1G1PE2EV, 2G1FA0E, 2G1PE1E, 2G1PE1EV, 2G1PE2E, 2G1PE2EV, 31GE, 31TCE, 32TCE		

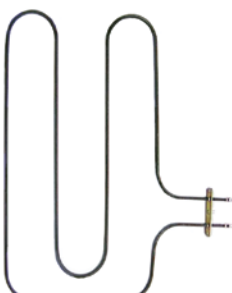

1

código	415169	referencia	32G0950 32G0951 32G1601
descripción	resistencia 2700W 380V L 450mm An 590mm L1 115mm L2 335mm B1 370mm B2 60mm longitud brida 100mm anchura brida 22mm dist. del agujero 86mm agujero ø 5mm tubo ø 6.5mm empalme conector Faston 6,3mm espirales 1 brida rectangular resistencia seca		
Para modelos:	08WFA4E, 08WFAAE, 10WTPGE, 12WFA6E, 12WFAAE, 191FAAE, 191FAE, 191FAG, 191PE4E, 1A1PE4E, 1A1PEFTE, 1A1FBE, 1D1PE4E, 1D1FBE, 6043590, 71E, 71GE, 71GEGG, FS30E		

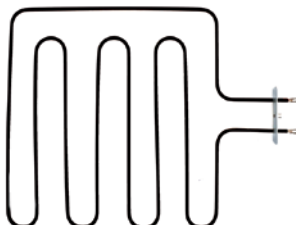

1

código	418641	referencia	32G3250
descripción	resistencia 2700W 400V espirales 1 L 465mm An 385mm L1 100mm L2 365mm B1 162mm B2 61mm longitud brida 100mm anchura brida 22mm dist. del agujero 86mm agujero ø 5mm tubo ø 6.5mm empalme conector Faston 6,3mm longitud de empalme 45mm pos. de montaje arriba brida rectangular resistencia seca		
Para modelos:	1G1FA0E, 1G1FA0EV, 1G1PE1E, 1G1PE1EV, 1G1PE2E, 1G1PE2EV, 2G1FA0E, 2G1PE1E, 2G1PE1EV, 2G1PE2E, 2G1PE2EV		

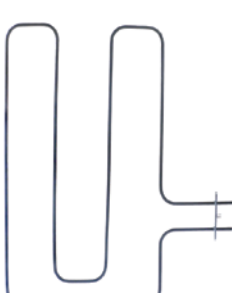

1

código	418837	referencia	32G1220
descripción	resistencia 2940W 230V L 455mm An 590mm L1 115mm L2 340mm B1 370mm B2 60mm longitud brida 100mm anchura brida 22mm dist. del agujero 86mm agujero ø 5mm tubo ø 6.3mm longitud de empalme 55mm espirales 1 horno		
Para modelos:	71E, FS30E		



			
código	416676	referencia	32G0160
descripción	resistencia 800W 230V espirales 1 L 405mm An 122mm H 16mm L1 42mm L2 363mm B1 30mm B2 62mm longitud brida 100mm anchura brida 22mm dist. del agujero 86mm agujero ø M4mm tubo ø 8.5mm empalme conector Faston 6,3mm brida rectangular resistencia seca		



			
código	415171	referencia	32G0080
descripción	resistencia 900W 230V espirales 1 L 430mm An 122mm H 28mm L1 55mm L2 375mm B1 30mm B2 62mm longitud brida 100mm anchura brida 22mm dist. del agujero 86mm agujero ø 4mm tubo ø 6.3mm empalme conector Faston 6,3mm brida rectangular resistencia seca		





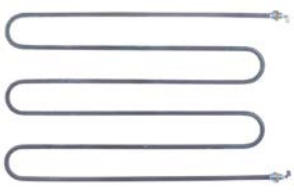

resistencias para baño maría

			
código	416683	referencia	32G2220
descripción	resistencia 1000W 230V espirales 1 L 480mm An 35mm longitud brida 70mm anchura brida 22mm dist. del agujero 56mm longitud de empalme 28mm empalme M4 tubo ø 8.5mm brida rectangular agujero ø 5.5mm resistencia seca		
Para modelos:	04WBMEV, 090BM1E, 0A0BME, 0B0BME, 0D0BME, 190BM2E, 1A0BME, 1D0BME, 6040110, 6042680		

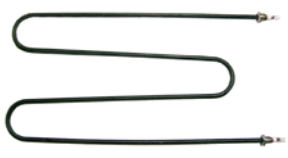
			
código	416682	referencia	32G0280
descripción	resistencia 1450W 230V L 378mm An 252mm empalme conector Faston 6,3mm tubo ø 8.5mm sujeción 2 orificios rosca 1/4" resistencia seca baño-maría distancia de sujeción 245mm		
Para modelos:	030EBM, 031EBM, 0G0BME, 1G0BME		

			
código	418688	referencia	32G1730
descripción	resistencia 1500W 230V L 470mm An 305mm tubo ø 8.5mm rosca 1/4" baño maría distancia de sujeción 297mm		
Para modelos:	ACBM, ACBM218, ANBM, ANBM218, ANBM75, SE14VB, SE21VB, SI14VB, SI21VB, SL14CVB, SL14NVB, SL21CVB, SL21NVB, SL7NVB, TBM, TBM218		

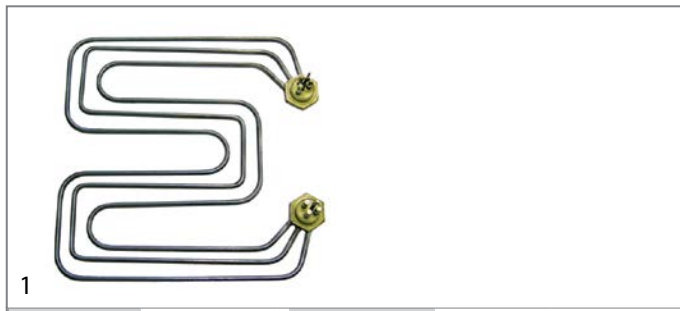

			
código	415173	referencia	32G0070 32G0071
descripción	resistencia 1600W 230V L 585mm An 200mm empalme M6 tubo ø 8.5mm sujeción 2 orificios rosca M14x1,5 resistencia de inmersión distancia de sujeción 184mm		
Para modelos:	070BME, 071BME, 090BME, 091BME		
accesorios para	415173		
	código	510417	referencia —
junta plana fibra ø ext. 20mm int.ø 14mm espesor 2mm UE 1 pzs			
	código	520228	referencia —
arandela dentada int.ø 15.3mm ø ext. 24mm acero UE 1 pzs para rosca M14			
	código	520230	referencia —
tuerca rosca M14x1,5 H 5mm EC 19 acero zincado UE 1 pzs			
	código	521101	referencia —
tuerca rosca M14x1,5 H 5mm EC 19 inox UE 1 pzs			
	código	550262	referencia —
junta plana cobre ø ext. 20mm int.ø 14mm espesor 2mm			

			
código	415181	referencia	32G1250
descripción	resistencia 2000W 230V espirales 1 L 458mm An 208mm empalme conector Faston 6,3mm tubo ø 8.5mm sujeción 2 orificios rosca M14x1 resistencia de inmersión distancia de sujeción 200mm		
Para modelos:	030BME, 031BME		
accesorios para	415181		
	código	510417	referencia —
junta plana fibra ø ext. 20mm int.ø 14mm espesor 2mm UE 1 pzs			
	código	520228	referencia —
arandela dentada int.ø 15.3mm ø ext. 24mm acero UE 1 pzs para rosca M14			
	código	521133	referencia —
tuerca rosca M14x1,5 H 6mm EC 19 acero zincado UE 1 pzs			
	código	550261	referencia —
tuerca rosca M14x1 H 4mm EC 19 inox UE 1 pzs			
	código	550262	referencia —
junta plana cobre ø ext. 20mm int.ø 14mm espesor 2mm			



código	415175	referencia	32G0650
descripción	resistencia 4800W 220V espirales 3 L 410mm An 417mm empalme M3 tubo ø 8.5mm brida roscada rosca 1¼" resistencia de inmersión H1 10mm H 19mm		
accesorios para	415175		
	código	510405	referencia N/A
	junta plana fibra ø ext. 56mm int.ø 42mm espesor 2mm para rosca 1¼" UE 1 pzs		
	código	520232	referencia —
	tuerca rosca 1¼" H 5mm latón niquelado EC 47 UE 1 pzs		
	código	527169	referencia —
	tuerca hexagonal rosca M3 H 2.8mm EC 5.5 latón UE 1 pzs		
	código	528021	referencia —
	junta plana PTFE ø ext. 53mm int.ø 42.5mm espesor 3mm UE 1 pzs núm. Ref. 12001/02286 para Astoria/Aurora/Brasilia/Wega		
	código	560110	referencia —
	arandela int.ø 3.2mm ø ext. 7mm espesor 0.5mm inox UE 20 pzs DIN 125A para rosca M3		
	código	560130	referencia —
	tuerca hexagonal rosca M3 H 2.4mm EC 5.5 inox DIN/ISO DIN 934 / ISO 4032/8673 UE 20 pzs		



código	415172	referencia	32G0090
descripción	resistencia 800W 230V L 405mm An 50mm empalme conector Faston 6,3mm tubo ø 8.5mm sujeción 2 orificios rosca M12x1 resistencia seca distancia de sujeción 42mm		
Para modelos:	OG0BME-VERS.032008, 1G0BME-VERS.032008		
repuestos para	415172		
	código	510417	referencia —
	junta plana fibra ø ext. 20mm int.ø 14mm espesor 2mm UE 1 pzs		
accesorios para	415172		
	código	520229	referencia —
	tuerca rosca M12x1 H 4mm EC 16 acero zincado UE 1 pzs		
	código	521110	referencia —
	junta plana fibra ø ext. 20mm int.ø 13mm espesor 2mm UE 1 pzs		

resistencias para freidora

empalme en el borde

otros

resistencias





código	419049	referencia	32G2610
descripción	resistencia 7200W 230V L 300mm An 155mm		
Para modelos:	04WFR3ED, 08WFR4ED, 091FR3E, 091FR3ED, 0A1FR3E, 0A1FR3ED, 0D1FR3E, 0D1FR3ED, 0G0FR3E, 0G0FR3ED, 191FR4E, 191FR4ED, 1A1FR4E, 1A1FR4ED, 1D1FR4E, 1D1FR4ED, 1G0FR4E, 6043840, 6043970		
accesorios para	419049		
	código	510219	referencia 60A0980
	juego de juntas tóricas UE 2 pzs		

empalme excéntrico

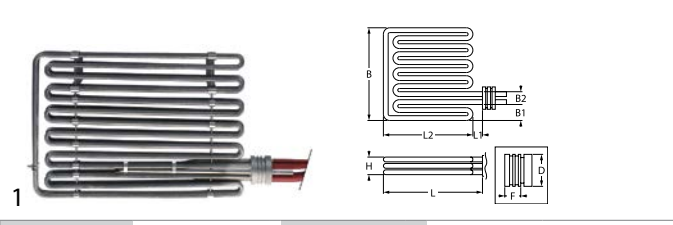
otros



código	416589	referencia	32G2400
descripción	resistencia 18000W 400V espirales 3 pos. de montaje izquierdo L 395mm An 270mm H 32mm longitud pletina 20mm brida ø 53.5mm ø casquillo portasondas 7mm longitud casquillo portasondas 315mm casquillo portasondas 1 casquillo termostato ajustado L1 15mm L2 380mm B1 34mm B2 41mm tubo ø 8.5mm longitud del cable 2000mm brida giratoria resistencia de inmersión freidora longitud de empalme 110mm		
Para modelos:	091FR1E, 091FR1EA, 091FR1ED, 0A1FR1E, 0A1FR1ED, 0D1FR1E, 0D1FR1ED, 191FR2E, 191FR2ED, 1A1FR2E, 1A1FR2ED, 1D1FR2ED		
accesorios para	416589		
	código	510219	referencia 60A0980
	juego de juntas tóricas UE 2 pzs		
	código	550494	referencia 3152150 3152151
	junta tórica Viton espesor 3.53mm int.ø 47.22mm UE 1 pzs		

sujeción 2 orificios

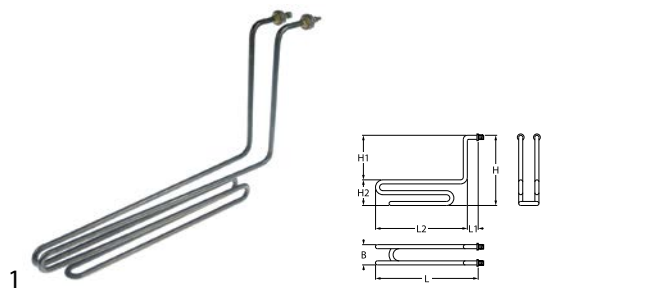

código	418597	referencia	32G0060
descripción	resistencia 2500W 230V espirales 1 L 460mm An 33mm H 275mm L1 45mm L2 415mm H1 220mm H2 55mm rosca 1/4" tubo ø 8.5mm espirales 3		

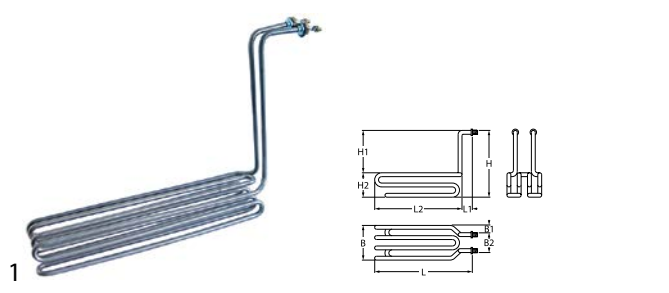

código	416588	referencia	32G0100 32G1181
descripción	resistencia 4700W 400V espirales 1 L 480mm An 90mm H 230mm L1 60mm L2 420mm B1 40mm B2 25mm H1 415mm H2 65mm rosca 1/4" distancia de sujeción 35mm tubo ø 8.5mm sujeción 2 orificios empalme M6 freidora espirales 6		

Para modelos: 70FE, 70FE1, 70FE1B, 71FE, 71FE2, 71FE2B

accesorios para 416588

	código	560113	referencia	3121480
		arandela int.ø 6.4mm ø ext. 12mm espesor 1.6mm inox UE 20 pzs DIN 125A para rosca M6		
	código	560133	referencia	—
		tuerca hexagonal rosca M6 H 5mm EC 10 inox DIN/ISO DIN 934 / ISO 4032/8673 UE 20 pzs		

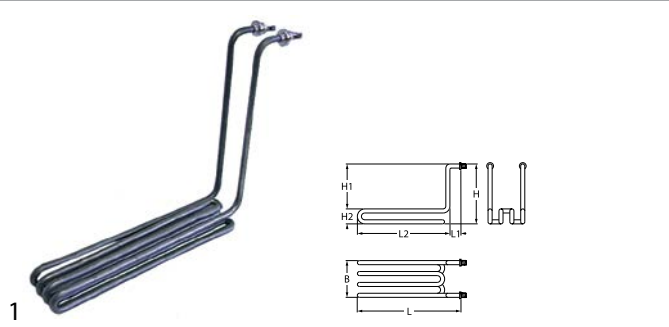

código	415180	referencia	32G1241
descripción	resistencia 2050W 230V espirales 1 L 305mm An 53mm H 245mm L1 30mm L2 275mm H1 210mm H2 35mm rosca 1/4" distancia de sujeción 22mm tubo ø 8.5mm sujeción 2 orificios empalme conector Faston 6,3mm resistencia para freidora espirales 4		

Para modelos: 030FE1, 030FE1B, 091FE28, 091FE28B, 30FES2, 30FES2B, 70FES2, 70FES2B

accesorios para 415180

	código	361182	referencia	3117580
		tuerca rosca 1/4" H 5mm latón niquelado EC 17 UE 1 pzs		
	código	510417	referencia	—
		junta plana fibra ø ext. 20mm int.ø 14mm espesor 2mm UE 1 pzs		

accesorios para 415180

	código	520228	referencia	—
		arandela dentada int.ø 15.3mm ø ext. 24mm acero UE 1 pzs para rosca M14		
	código	550262	referencia	—
		junta plana cobre ø ext. 20mm int.ø 14mm espesor 2mm		

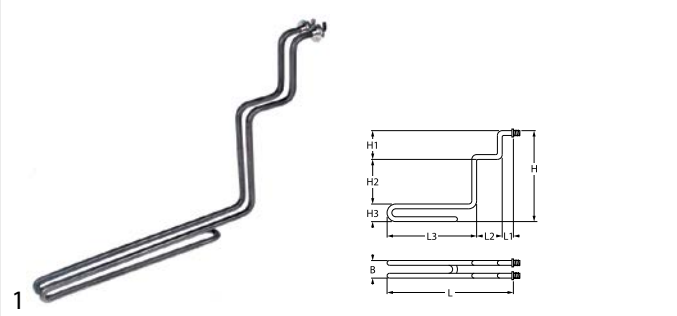

código	418760	referencia	32G0130
descripción	resistencia 1750W 230V L 415mm An 35mm H 260mm sujeción 2 orificios empalme 6,3x0,8 espirales 1 L1 30mm L2 70mm L3 315mm H1 30mm H2 135mm H3 24mm tubo ø 8.5mm rosca M13 distancia de sujeción 23mm longitud de empalme 7.5mm		

resistencias para plancha grills



código	416678	referencia	32G1040
descripción	resistencia 1700W 400V espirales 1 L 445mm An 75mm H 83mm tubo ø 8.8mm empalme conector Faston 6,3mm longitud de empalme 23mm plancha grill distancia de empalme 66mm resistencia seca		



código	415179	referencia	32G1260 32G1262
descripción	resistencia 1750W 230V espirales 1 L 445mm An 82mm H 50mm tubo ø 8.5mm empalme M4 plancha grill distancia de empalme 80mm resistencia seca		



código	418481	referencia	32G2371
descripción	resistencia 2200W 230V espirales 1 L 615mm An 83.5mm H 89mm tubo ø 8.5mm empalme conector Faston 6,3mm longitud de empalme 21mm distancia de empalme 75mm resistencia seca		

Para modelos: 090FT1E, 090FT2E, 090FT4E, 090FT5E, 090FT7E, 091FT1E, 091FT2E, 091FT4E, 091FT5E, 091FT7E, 0A0FT1E, 0A0FT2E, 0A0FT4E, 0A0FT5E, 0D0FT1E, 0D0FT2E, 0D0FT4E, 0D0FT5E, 190FT15E, 190FT1E, 190FT2E, 190FT3E, 190FT42E, 190FT4E, 190FT5E, 190FT6E, 190FT72E, 190FT7E, 191FT1E, 191FT2E, 191FT3E, 191FT4E, 191FT6E, 191FT7E, 1A0FT1E, 1A0FT2E, 1A0FT3E, 1A0FT4E, 1A0FT6E, 1A1PEFTE, 1D0FT1E, 1D0FT2E, 1D0FT3E, 1D0FT4E, 1D0FT6E





código	416680	referencia	32G2370
descripción	resistencia 2200W 230V espirales 1 L 615mm An 86mm H 92mm tubo ø 8.5mm empalme conector Faston 6,3mm plancha grill distancia de empalme 84mm resistencia seca		
Para modelos:	0A0FT1E, 0A0FT2E, 0A0FT4E, 0A0FT5E, 0D0FT1E, 0D0FT2E, 0D0FT4E, 0D0FT5E, 1A0FT1E, 1A0FT2E, 1A0FT3E, 1A0FT4E, 1A0FT6E, 1D0FT1E, 1D0FT2E, 1D0FT3E, 1D0FT4E, 1D0FT6E		



código	416679	referencia	32G1870
descripción	resistencia 2200W 400V espirales 1 L 572mm An 81mm H 85mm tubo ø 8.5mm empalme conector Faston 6,3mm plancha grill distancia de empalme 75mm resistencia seca		
Para modelos:	070FTE04, 070FTE05, 071FTE04, 071FTE06, 090FTE04, 090FTE05, 091FTE04, 091FTE06		

resistencias para refrigeración

resistencias de descongelación



código	418600	referencia	32G1021
descripción	resistencia 160W 220V L 540mm An 170mm tubo ø 4.5mm descongelación		
Para modelos:	K16APGPZ, K16XPZAP, SA16AGB, SA16GB		



código	418609	referencia	32G0350
descripción	resistencia 2x110W 2x115V L 620mm longitud del cable 2000mm tubo ø 8.5mm descongelación		
Para modelos:	65NB, 6BEABA, 6BEABB, 6BEABM, 6BEABZ, 6BEBBA, 6BEBBB, 6BEBBM, 6BEBBZ, 6BECBA, 6BECBB, 6BECBM, 6BECBZ, 6BMABA, 6BMABB, 6BMABM, 6BMABZ, 6MBBBA, 6MBBBB, 6MBBBM, 6MBBBZ, 6BMCBA, 6BMCBB, 6BMCBM, 6BMCBZ, 6RA, 6RA2, 6RA2A, 6RA2M, 6RA2Z, 6RA4, 6RA4A, 6RA4M, 6RA4Z, 6RAA, 6RAM, 6RAZ, 6RB, 6RB11, 6RB11A, 6RB11M, 6RB11Z, 6RB2, 6RB2A, 6RB2M, 6RB2Z, 6RB4, 6RB4A, 6RB4M, 6RB4Z...(Otros modelos se puede ver en la tienda web)		



código	418594	referencia	32G1970
descripción	resistencia 400W 220V L 480mm An 140mm H 80mm longitud del cable 1000mm tubo ø 8.5mm descongelación		
Para modelos:	S60B, S60B-2, S60BE, S60BX, S60BX-2		

resistencias para sartenes basculantes



código	416595	referencia	32G1920 32G1921
descripción	resistencia 1500W 230V L 415mm An 82mm H 50mm empalme M4 resistencia seca espirales 1 tubo ø 8.5mm distancia de empalme 65mm		
Para modelos:	31RE		



código	416596	referencia	32G0251
descripción	resistencia 1750W 230V L 500mm An 81mm H 50mm empalme M4 resistencia seca espirales 1 tubo ø 8.5mm L1 18mm B1 10mm B2 47mm distancia de empalme 73mm		
Para modelos:	71ARE, 91ARE		





código	416597	referencia	32G2481
descripción	resistencia 2000W 230V L 530mm An 93mm H 70mm empalme M4 resistencia seca espirales 1 tubo ø 8.5mm distancia de empalme 83mm		
Para modelos:	191BR1E, 191BR2E, 191BR2EA, 1A1BR1E, 1A1BR2E, 1A1BR2EA, 1D1BR1E, 1D1BR2E, 1D1BR2EA, 291BR1E, 291BR2E, 291BR2EA, 2A1BR1E, 2A1BR2E, 2A1BR2EA, 2D1BR1E, 2D1BR2E, 2D1BR2EA		

resistencias para cuecepastas









código	415020	referencia	32G0230 32G0380
descripción	resistencia 4500W 230V montaje ø 57.5mm espirales 3 L 355mm An 35mm H 47mm casquillo portasondas 1 ø casquillo portasondas 7mm longitud casquillo portasondas 295mm casquillo termostato arriba tubo ø 8.5mm dist. del agujero 70mm agujero ø 10mm longitud de empalme 25mm empalme conector Faston 6,3mm brida 3 orificios resistencia de inmersión		
Para modelos:	0G1CP1EC, F60P, F60PR, F60T, L100, L40S, L60, L80		





código	418602	referencia	32G3270
descripción	resistencia 4500W 400V espirales 3 L 315mm An 36mm H 48mm ø casquillo portasondas 7.5mm longitud casquillo portasondas 285mm dist. del agujero 72mm montaje ø 57.5mm casquillo portasondas 1 casquillo termostato descentrado, no ceñido		
Para modelos:	0G1CP1E, 0G1CP1EC, 0G1CP1E-VERS.2004, 1G1PI1E, 6043850, 6043980		
accesorios para	418602		
	código	510409	referencia
			3150430 3151960 37Q5260
	junta tórica EPDM espesor 5.34mm int.ø 56.52mm UE 1 pzs		





			
código	415182	referencia	32G1300 32G1301 32G1930
descripción	resistencia 4540W 230V espirales 3 L 323mm An 36mm H 48mm brida redonda empalme M4 tubo ø 8.5mm ø casquillo portasondas 7.5mm longitud casquillo portasondas 300mm montaje ø 57.5mm casquillo portasondas 1 casquillo termostato descentrado, ceñido cocedora de pasta		
Para modelos:	30CPSE, 70CPE, 90CPE		
repuestos para	415182		
	código	510409	referencia 3150430 3151960 37Q5260
junta tórica EPDM espesor 5.34mm int.ø 56.52mm UE 1 pzs			
accesorios para	415182		
	código	521103	referencia N/A
tuerca rosca M4 H 3mm EC 7 latón UE 20 pzs			
	código	521104	referencia —
arandela int.ø 4.3mm ø ext. 8mm espesor 0.5mm latón UE 20 pzs para rosca M4			
	código	550002	referencia 3113780
estribo de fijación H 10mm L 21mm An 10mm agujero ø 6.5mm para resistencia			
	código	560111	referencia —
arandela int.ø 4.3mm ø ext. 9mm espesor 0.8mm inox UE 20 pzs DIN 125A para rosca M4			
	código	560131	referencia —
tuerca hexagonal rosca M4 H 3.2mm EC 7 inox DIN/ISO DIN 934 / ISO 4032/8673 UE 20 pzs			

			
código	416681	referencia	32G2310
descripción	resistencia 6000W 400V espirales 3 L 485mm An 37mm H 40mm brida 3 orificios empalme M4 tubo ø 8.5mm ø casquillo portasondas 7mm longitud casquillo portasondas 445mm dist. del agujero 70mm montaje ø 57.5mm agujero ø 10mm casquillo portasondas 1 longitud de empalme 30mm casquillo termostato arriba cocedora de pasta		
Para modelos:	04WCP1EM, 091CP1E, 0A1CP1E, 0D1CP1E, 6040090, 6040310		
repuestos para	416681		
	código	510409	referencia 3150430 3151960 37Q5260
junta tórica EPDM espesor 5.34mm int.ø 56.52mm UE 1 pzs			

resistencias fry top

			
código	415148	referencia	32G0140
descripción	resistencia 750W 230V L 519mm An 35mm H 105mm sujeción 2 orificios distancia de sujeción 26mm empalme conector Faston 6,3mm L1 30mm L2 489mm tubo ø 8.5mm resistencia seca rosca 1/4"		
accesorios para	415148		
	código	361182	referencia 3117580
tuerca rosca 1/4" H 5mm latón niquelado EC 17 UE 1 pzs			

accesorios para	415148		
	código	510417	referencia —
junta plana fibra ø ext. 20mm int.ø 14mm espesor 2mm UE 1 pzs			
	código	520228	referencia —
arandela dentada int.ø 15.3mm ø ext. 24mm acero UE 1 pzs para rosca M14			
	código	550262	referencia —
junta plana cobre ø ext. 20mm int.ø 14mm espesor 2mm			

resistencias para salamandras / tostadores

			
código	415758	referencia	32G1441 32G1580
descripción	resistencia 1300W 230V espirales 1 L 238mm An 132mm H 72mm distancia de empalme 124mm tubo ø 8.5mm longitud del cable 900mm resistencia seca longitud de empalme 20mm		
Para modelos:	60SME		

resistencias para repisas infrarrojos

			
código	418202	referencia	3003800
descripción	resistencia 500W 220V espirales 1 L 485mm Anmm longitud de lengüeta 40mm anchura de lengüeta 18mm empalme M5 tubo ø 6.3mm brida rectangular agujero ø M4mm resistencia seca		

cables de calefacción

empalme ambos lados

con faston macho

			
código	418761	referencia	32G2420
descripción	cable de calefacción 25W 230V L 5000mm ø 4mm		
Para modelos:	40CP-OPR01, 40CPX-OPR01, AF1B, AF1B-OPR01, AF1N, AF1N-OPR01, AF2B, AF2B-OPR01, AF2N, AF2N-OPR01, CX120, CX120B, CX120NN, CX130B, CX140, CX140B, CX140BN, CX140BR, CX140CP, CX140NN, CX140PV, CX140R, CX150B, CX150BN, CX150BR, CX150CP, CX150R, CX55, CX55B, CX60B, CX65, CX652, CX65B, CX65BR, CX65NB, CX65NCP, CX65NN, CX65PV, CX65R, CX70B, CX70BR, CX70NB, CX70NN, CX70R, FG2B, FSD1B, FSD1N, FSD2B, FSD2N, FSD2N2...(Otros modelos se puede ver en la tienda web)		

			
código	420382	referencia	32G3290
descripción	cable de calefacción 31W 230V L 5000mm para abatidor de temperatura empalme conector Faston		
Para modelos:	DS31, DS31A, DS31C, DS31M, DS51, DS51A, DS51C, DS51M, IS51, IS51A, IS51AR, IS51C, IS51CR, IS51M, IS51MR, IS51R, IS51W, IS51WA, IS51WC, IS51WM, SM03LT7, SM03LT7A, SM03LT7M, SM1L7, SM1L7A, SM1L7FCV, SM1L7M, SM1LT7, SM1LT7A, SM1LT7M		



código	420383	referencia	32G2280
descripción	cable de calefacción 45W 230V L 6000mm para abatidor de temperatura empalme conector Faston		
Para modelos:	IS101L, IS101LR, IS101LW, IS101S, IS101SR, IS101SW, SM2L, SM2LR, SM2LW, SM2S, SM2SR, SM2SW		



código	420384	referencia	32G3500
descripción	cable de calefacción 53W 230V L 6800mm para abatidor de temperatura empalme conector Faston		
Para modelos:	IS102S, IS102SR, IS102SR-0NR01, IS102SW, IS72S, IS72SR, IS72SW		



código	418755	referencia	32G1820
descripción	cable de calefacción 80W 220V ø 3mm empalme conector Faston 6,3mm longitud del cable 5250mm		
Para modelos:	135BN, 135BNX, 135CPX, 135NN, 135NNX, 40CP, 40CPX, 55B, 65, 65B, 65BA, 65BX, 65BX-2, 65BXE, 65BXR, 65NB, 65NBX, 65PVX, 65X, 65X-2, 65XR, SP120BN, SP120NN, SP135BN, SP135CP, SP135NN, SP55, SP55B, SP65, SP65B, SP65NB		

empalme ambos lados (con revestimiento de metal trenzado)



código	419170	referencia	32G0240
descripción	cable de calefacción 100W 230V L1 (sin calentam.) 600mm L2 (con calentam.) 6600mm ø 4mm UE 1		
Para modelos:	6BEA11A, 6BEA11B, 6BEA11M, 6BEA11Z, 6BEA2A, 6BEA2B, 6BEA2M, 6BEA2Z, 6BEA3A, 6BEA3B, 6BEA3M, 6BEA3Z, 6BEAA, 6BEAB, 6BEABA, 6BEABB, 6BEABM, 6BEABZ, 6BEAM, 6BEAZ, 6BEB11A, 6BEB11B, 6BEB11M, 6BEB11Z, 6BEB22A, 6BEB22B, 6BEB22M, 6BEB22Z, 6BEB2A, 6BEB2B, 6BEB2M, 6BEB2Z, 6BEB3A, 6BEB3B, 6BEB3M, 6BEB3Z, 6BEB4A, 6BEB4B, 6BEB4M, 6BEB4Z, 6BEBA, 6BEBB, 6BEBBA, 6BEBBB, 6BEBBM, 6BEBBZ, 6BEBM, 6BEBZ, 6BEC11A, 6BEC11B...(Otros modelos se puede ver en la tienda web)		



código	419109	referencia	32G1810
descripción	cable de calefacción 150W 220V L1 (sin calentam.) 2x1000mm L2 (con calentam.) 5000mm ø 3.5mm L 7000mm empalme conector Faston 6,3mm		
Para modelos:	120B, 135, 135-4, 135B, 135BA, 135BX, 135BXE, 135BXR, 135PVX, 135X, 135X-3, 135X-4, 135XR, ISP202R, ISR201R, ISR202R, SP120, SP120B, SP135, SP135B		

cartuchos calentadores



código	418892	referencia	32G3310		
descripción	cartucho calentador 300W 230V ø 12mm L 240mm rosca 3/8" longitud del cable 2000mm resistencia de inmersión				
Para modelos:	AF1N, AF1N-0PR01, AF2N, AF2N-0PR01, CX120, CX120NN, CX130, CX130NN, CX140, CX140BN, CX140BR, CX140CP, CX140NN, CX140PV, CX140R, CX150, CX150BN, CX150BR, CX150CP, CX150NN, CX150PV, CX150R, CX55, CX60, CX65, CX652, CX65BR, CX65NB, CX65NCP, CX65NN, CX65PV, CX65R, CX70, CX702, CX70BR, CX70NB, CX70NN, CX70PV, CX70R, FSD1N, FSD2N, FSD2N2, FSDR1B-0PR01, FSDR1N-0PR01, FSDR2B-0PR01, FSDR2B2-0PR01, FSDR2N, FSDR2N-0PR01, FSDR2N2-0PR01, FSE2N...(Otros modelos se puede ver en la tienda web)				
accesorios para	418892	código	511472	referencia	—
	tuerca rosca 3/8" H 4mm latón EC 21 UE 1 pzs				
	código	518393	referencia	—	
	junta plana FIBER ø ext. 24mm int.ø 17mm espesor 2mm UE 1 pzs				



código	417747	referencia	3134541
descripción	cartucho calentador 150W 230V ø 10mm L 165mm empalme conector Faston hembra 6,3mm longitud del cable 520mm		

registros de calefacción



código	415122	referencia	32G1990
descripción	registro de calefacción distancia de sujeción 185mm An 40mm H 35mm 2000W 230V limitación de temperatura 105°C espirales 2 empalme cable longitud del cable 340mm L 197mm para soplador transversal		

resistencias de tubo de aletas





código	419164	referencia	32G2200
descripción	resistencia 1500W 230V L 345mm An 95mm rosca 3/8" empalme M6 longitud de empalme 46mm lavavajillas resistencia seca espirales 1 sujeción 2 orificios		
Para modelos:	TA9C, TA9C-VERS.2006		





resistencias de inmersión

brida 3 orificios \varnothing 38,5mm

			
código	416277	referencia	3030200
descripción	resistencia 2800W 230V montaje \varnothing 38.5mm espirales 1 L 302mm An 37mm H 28mm casquillo portasondas 1 \varnothing casquillo portasondas 7mm longitud casquillo portasondas 199mm casquillo termostato no ajustado tubo \varnothing 6.4mm dist. del agujero 57mm agujero \varnothing 10mm longitud del cable 114mm brida 3 orificios empalme 26 resistencia de inmersión		
accesorios para	416277		
	código	532577	referencia —
	junta tórica EPDM espesor 5.34mm int. \varnothing 40.65mm UE 1 pzs		

			
código	420037	referencia	3104990
descripción	resistencia 4000W 230V montaje \varnothing 38.5mm espirales 3 L 300mm An 33mm H 27mm tubo \varnothing 6.4mm dist. del agujero 57mm agujero \varnothing 10mm empalme conector Faston 6,3mm vertical		
Para modelos:	KD40, KD40PS, KD40-VERS.112009		

			
código	420061	referencia	3075840
descripción	resistencia 3500W 230V espirales 3 L 366mm An 35mm H 60mm L1 30mm L2 56mm L3 280mm H1 36mm H2 24mm dist. del agujero 57mm agujero \varnothing 10mm tubo \varnothing 6.2mm empalme conector Faston 6,3mm		
Para modelos:	LF50EM		
accesorios para	420061		
	código	532577	referencia —
	junta tórica EPDM espesor 5.34mm int. \varnothing 40.65mm UE 1 pzs		

			
código	416267	referencia	32G2140
descripción	resistencia 4500W 230V montaje \varnothing 38.5mm espirales 3 L 358mm An 32mm H 58mm L1 36mm L2 72mm L3 250mm H1 28mm H2 30mm dist. del agujero 57mm agujero \varnothing 10mm tubo \varnothing 6.3mm empalme conector Faston 6,3mm resistencia de inmersión brida 3 orificios		
Para modelos:	CS243D, CS243D-VERS.2006, CS243S, CS243VD, CS243VS, CS370AD, CS370AD-VERS.2006, CS370AS, CS370AS-VERS.2006, CS370AVD, CS370AVS, CS370D, CS370D-VERS.2006, CS370S, CS370S-VERS.2006, CS370VD, CS370VS, CS466AD, CS466AD-VERS.2006, CS466AS, CS466AS-VERS.2006, CS466AVD, CS466AVS, CS466D, CS466D-VERS.2006, CS466S, CS466S-VERS.2006, CS466VD, CS466VS, LF50E, LF50EMPS, LF50EM-VERS.122012, LF50E-VERS.122012, LF50E-VERS.2007, N303D, N303S, N303VD, N303VS, N354D, N354S, N354VD, N354VS, N506D, N506S, N506VD, N506VS, N607D, N607S, N607VD, N607VS		
accesorios para	416267		
	código	532577	referencia —
	junta tórica EPDM espesor 5.34mm int. \varnothing 40.65mm UE 1 pzs		

			
código	416268	referencia	32G2180
descripción	resistencia 6000W 230V montaje \varnothing 38.5mm espirales 3 L 360mm An 34mm H 55mm L1 35mm L2 70mm L3 255mm H1 27mm H2 28mm dist. del agujero 57mm agujero \varnothing 10mm tubo \varnothing 6.3mm empalme conector Faston 6,3mm resistencia de inmersión brida 3 orificios		
repuestos para	416268		
	código	532577	referencia —
	junta tórica EPDM espesor 5.34mm int. \varnothing 40.65mm UE 1 pzs		

brida 3 orificios \varnothing 38,5mm

código	416269	referencia	32G2170
descripción	resistencia 8000W 230V montaje \varnothing 38.5mm espirales 3 L 545mm An 32mm H 60mm L1 38mm L2 55mm L3 447mm H1 27mm H2 33mm dist. del agujero 57mm agujero \varnothing 10mm tubo \varnothing 6.3mm empalme conector Faston 6,3mm resistencia de inmersión brida 3 orificios		
Para modelos:	C165D, C165S, C165VD, C165VS, C207D, C207D-VERS.2006, C207S, C207S-VERS.2006, C207VD, C207VS, C304AD, C304AD-VERS.2006, C304AS, C304AS-VERS.2006, C304AVD, C304AVS, C304D, C304D-VERS.2006, C304S, C304S-VERS.2006, C304VD, C304VS, C92D-VERS.2006, C92S-VERS.2006, CS243D, CS243D-VERS.2006, CS243S, CS243S-VERS.2006, CS243VD, CS243VS, CS370AD, CS370AD-VERS.2006, CS370AS, CS370AS-VERS.2006, CS370AVD, CS370AVS, CS370D, CS370D-VERS.2006, CS370S, CS370S-VERS.2006, CS370VD, CS370VS, CS466AD, CS466AD-VERS.2006, CS466AS, CS466AS-VERS.2006, CS466AVD, CS466AVS, CS466D, CS466D-VERS.2006... (Otros modelos se puede ver en la tienda web)		
accesorios para	416269		
	código	532577	referencia —
	junta tórica EPDM espesor 5.34mm int. \varnothing 40.65mm UE 1 pzs		

brida 3 orificios \varnothing 47,5mm

código	415013	referencia	32G0390 32G0790
descripción	resistencia 2400W 230V montaje \varnothing 47.5mm espirales 1 L 215mm An 40mm H 35mm casquillo portasondas 1 \varnothing casquillo portasondas 6.5mm longitud casquillo portasondas 190mm casquillo termostato descentrado, no ceñido tubo \varnothing 6.5mm dist. del agujero 64mm agujero \varnothing 8x10mm empalme conector Faston 6,3mm brida 3 orificios resistencia de inmersión		
Para modelos:	L40, L45		
accesorios para	415013		
	código	510408	referencia 3152650
	junta tórica EPDM espesor 5.34mm int. \varnothing 47mm UE 1 pzs		
	código	510562	referencia —
	junta tórica silicona espesor 5.34mm int. \varnothing 47mm UE 1 pzs		

brida 3 orificios \varnothing 57,5mm

código	418249	referencia	32G2150
descripción	resistencia 10000W 230V montaje \varnothing 57.5mm espirales 3 L 512mm An 50mm H 33mm casquillo portasondas 1 \varnothing casquillo portasondas 8.5mm longitud casquillo portasondas 458mm casquillo termostato descentrado, ceñido tubo \varnothing 6.3mm dist. del agujero 70mm agujero \varnothing 9mm longitud de empalme 30mm empalme M4 brida 3 orificios resistencia de inmersión		
Para modelos:	C304AD, C304AD-VERS.2006, C304AS, C304AS-VERS.2006, C304D, C304D-VERS.2006, C304S, C304S-VERS.2006, CS243D, CS243S, CS243VD, CS243VS, CS370AD, CS370AS, CS370AVD, CS370AVS, CS370D, CS370D-VERS.2006, CS370S, CS370S-VERS.2006, CS370VD, CS370VS, CS466AD, CS466AS, CS466AVD, CS466AVS, CS466D, CS466S, CS466VD, CS466VS, LC130-VERS.2001		

brida 3 orificios \varnothing 57,5mm

código	415023	referencia	32G0840
descripción	resistencia 12500W 230V montaje \varnothing 57.5mm espirales 3 L 630mm An 36mm H 48mm casquillo portasondas 1 \varnothing casquillo portasondas 7mm longitud casquillo portasondas 295mm casquillo termostato descentrado, no ceñido tubo \varnothing 8.5mm dist. del agujero 76mm agujero \varnothing 8x10mm empalme M5 brida 3 orificios resistencia de inmersión		
repuestos para	415023		
	código	510409	referencia 3150430 3151960 37Q5260
	junta tórica EPDM espesor 5.34mm int. \varnothing 56.52mm UE 1 pzs		

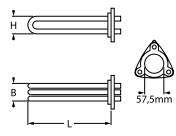

brida 3 orificios \varnothing 57,5mm

código	419138	referencia	32G2000 32G2340 32G2840
descripción	resistencia 14000W 230V montaje \varnothing 57.5mm espirales 3 L 515mm An 37mm H 50mm casquillo portasondas 1 \varnothing casquillo portasondas 7.5mm longitud casquillo portasondas 450mm casquillo termostato arriba tubo \varnothing 10mm dist. del agujero 72mm agujero \varnothing 8x10mm longitud de empalme 30mm empalme M5 brida 3 orificios resistencia de inmersión		
Para modelos:	C165D, C165S, C207D, C207D-VERS.2006, C207S, C207S-VERS.2006, C92D-VERS.2006, C92S-VERS.2006, CS243D-VERS.2006, CS243S-VERS.2006, LP124, LP124S-VERS.052006, LP124-VERS.052006		
accesorios para	419138		
	código	510409	referencia 3150430 3151960 37Q5260
	junta tórica EPDM espesor 5.34mm int. \varnothing 56.52mm UE 1 pzs		

código	415020	referencia	32G0230 32G0380
descripción	resistencia 4500W 230V montaje ø 57.5mm espirales 3 L 355mm An 35mm H 47mm casquillo portasondas 1 ø casquillo portasondas 7mm longitud casquillo portasondas 295mm casquillo termostato arriba tubo ø 8.5mm dist. del agujero 70mm agujero ø 10mm longitud de empalme 25mm empalme conector Faston 6,3mm brida 3 orificios resistencia de inmersión		
Para modelos:	OG1CP1EC, F60P, F60PR, F60T, L100, L40S, L60, L80		

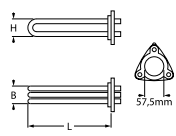



código	415021	referencia	32G0400 32G0420 32G0520 32G0920	
descripción	resistencia 6000W 230V montaje ø 57.5mm espirales 3 L 343mm An 37mm H 50mm casquillo portasondas 1 ø casquillo portasondas 7mm longitud casquillo portasondas 294mm casquillo termostato no ajustado tubo ø 8.5mm dist. del agujero 72mm agujero ø 8mm empalme M5 brida 3 orificios			
Para modelos:	F60P, F60PR, F60T, F80P, F80PR, L100, L45, L60, L80			
repuestos para	415021			
	código	510409	referencia	3150430 3151960 37Q5260
junta tórica EPDM espesor 5.34mm int.ø 56.52mm UE 1 pzs				
accesorios para	415021			
	código	550002	referencia	3113780
estribo de fijación H 10mm L 21mm An 10mm agujero ø 6.5mm para resistencia				

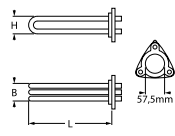

código	418585	referencia	32G2580
descripción	resistencia 6000W 400V montaje ø 57.5mm espirales 3 L 324mm An 42mm H 30mm casquillo portasondas 1 ø casquillo portasondas 7mm longitud casquillo portasondas 280mm casquillo termostato descentrado, ceñido tubo ø 8.5mm dist. del agujero 74mm agujero ø 8/10mm longitud de empalme 10mm empalme M4 brida 3 orificios resistencia de inmersión		
Para modelos:	LC100, LC100-VERS.2001, LC80, LF50, LP84S-VERS.052006, LP84-VERS.052006		



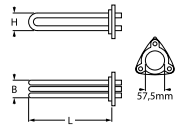

código	415022	referencia	32G0850 32G2100 32G2720	
descripción	resistencia 9000W 230/400V montaje ø 57.5mm espirales 3 L 475mm An 36mm H 43mm casquillo portasondas 1 ø casquillo portasondas 7mm longitud casquillo portasondas 300mm casquillo termostato descentrado, no ceñido tubo ø 10mm dist. del agujero 73mm agujero ø 10mm longitud de empalme 30mm empalme M5 brida 3 orificios resistencia de inmersión			
repuestos para	415022			
	código	510409	referencia	3150430 3151960 37Q5260
junta tórica EPDM espesor 5.34mm int.ø 56.52mm UE 1 pzs				

código	418586	referencia	32G2720
descripción	resistencia 9000W 230V montaje ø 57.5mm espirales 3 L 515mm An 37mm H 46mm casquillo portasondas 1 ø casquillo portasondas 7mm longitud casquillo portasondas 440mm casquillo termostato descentrado, ceñido dist. del agujero 73mm		
Para modelos:	CS370AD-VERS.2006, CS370AS-VERS.2006, CS370D-VERS.2006, CS370S-VERS.2006, CS466AD-VERS.2006, CS466AS-VERS.2006, CS466D-VERS.2006, CS466S-VERS.2006, LC130, LP84, LP84S-VERS.052006, LP84-VERS.052006, N303D, N303S, N354D, N354S, N506S, N607D, N607S, N760D, N760S, N886D, N886S		

con brida de presión 50 x 26mm

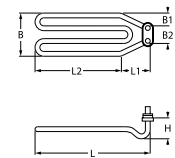
código	416209	referencia	32G2070	
descripción	resistencia 2000W 230V espirales 1 brida de presión brida 50x26mm L 180mm An 90mm H 24mm L1 55mm L2 125mm B1 28mm B2 35mm empalme conector Faston 6,3mm tubo ø 8.5mm longitud de empalme 28mm resistencia de inmersión			
Para modelos:	LF50EM, LF50EMPS, LF50EMPS-VERS.122012, LF50EM-VERS.122012, LF50E-VERS.122012, LF50E-VERS.2007, LP70			
accesorios para	416209			
	código	510387	referencia	—
junta L 46mm An 22mm ømm EPDM para resistencia para brida 50x26mm				



con brida de presión 62 x 26mm

código	415268	referencia	3030180
descripción	resistencia 1850-2020W 230-240V espirales 1 brida de expansión brida 62x26mm L 245mm An 40mm H 25mm tubo ø 6.5mm empalme conector Faston 6,3mm resistencia de inmersión		

código	415270	referencia	32g3360
descripción	resistencia 2700W 230V espirales 1 brida de presión brida 62x26mm L 335mm An 43mm H 25mm tubo ø 6.3mm empalme conector Faston 6,3mm resistencia de inmersión		
Para modelos:	KD100, KD100A, KD100PSD, KD60, KD60E, KD60EAT, KD60M, KD60MA, KD60ME, KD60MPS, KD60MPSA, KD60PS, KD60PSD, KD6E-ATSD, KD85, KD85A, KD85E, KD85EA, KD85EAT, KD85EATS, KD85EPS, KD85EPSA, KD85PS, KD85PSA, KN1100, KN1100SD, KN11PSDD, KN50, KN50M, KN50MPS, KN50PS, KN50PSD, KN50PSDD, KN80, KN800, KN800PSD, KN80PS, LP70		

con brida de expansión 70 x 18mm

código	418588	referencia	32G0120
descripción	resistencia 1000W 220V espirales 1 brida 70x18mm L 175mm An 83mm H 55mm empalme conector Faston 6,3mm tubo ø 8.3mm		

código	418598	referencia	32G0190
descripción	resistencia 1500W 220V espirales 1 brida 70x18mm L 175mm An 83mm H 55mm empalme conector Faston 6,3mm resistencia de inmersión tubo ø 8.5mm		



con brida redonda ø 47,5mm

código	415249	referencia	32G0480
descripción	resistencia 1500W 220V espirales 1 montaje ø 47.5mm L 220mm An 36mm H 49mm brida redonda empalme conector Faston 6,3mm resistencia de inmersión tubo ø 6.5mm longitud de empalme 18mm ø casquillo portasondas 7.5mm casquillo portasondas 1 longitud casquillo portasondas 181mm casquillo termostato no ajustado		
repuestos para	415249		
	código	referencia	3152650
	510408		
	junta tórica EPDM espesor 5.34mm int.ø 47mm UE 1 pzs		
accesorios para	415249		
	código	referencia	—
	510562		
	junta tórica silicona espesor 5.34mm int.ø 47mm UE 1 pzs		
	código	referencia	—
	520235		
	brida tres orificios dist. del agujero 70.5mm ø perforación 6.5mm int.ø 53.5mm		
	código	referencia	—
	520236		
	brida para resistencia int.ø 50mm ø ext. 90mm agujero ø 6.5mm 3 orificios		
	código	referencia	3113780
	550002		
	estribo de fijación H 10mm L 21mm An 10mm agujero ø 6.5mm para resistencia		
	código	referencia	—
	550362		
	brida ciega ø 64mm montaje ø 47.5mm		

código	415043	referencia	32g0540
descripción	resistencia 2500W 230V espirales 1 montaje ø 47.5mm L 225mm An 41mm H 36mm brida redonda empalme conector Faston 6,3mm resistencia de inmersión tubo ø 6.5mm longitud de empalme 17mm ø casquillo portasondas 7mm casquillo portasondas 1 longitud casquillo portasondas 210mm casquillo termostato descentrado, no ceñido		
Para modelos:	LT10R, LT20F, LT25F		
repuestos para	415043		
	código	referencia	3152650
	510408		
	junta tórica EPDM espesor 5.34mm int.ø 47mm UE 1 pzs		
accesorios para	415043		
	código	referencia	3152650
	510408		
	junta tórica EPDM espesor 5.34mm int.ø 47mm UE 1 pzs		
	código	referencia	—
	510562		
	junta tórica silicona espesor 5.34mm int.ø 47mm UE 1 pzs		
	código	referencia	—
	520235		
	brida tres orificios dist. del agujero 70.5mm ø perforación 6.5mm int.ø 53.5mm		
	código	referencia	—
	520236		
	brida para resistencia int.ø 50mm ø ext. 90mm agujero ø 6.5mm 3 orificios		

Continúa en la página siguiente



accesorios para	415043		
	código	550002	referencia 3113780
	estribo de fijación H 10mm L 21mm An 10mm agujero ø 6.5mm para resistencia		
	código	550362	referencia —
	brida ciega ø 64mm montaje ø 47.5mm		



1			
código	415269	referencia	32G3400
descripción	resistencia 2700W 230V espirales 3 montaje ø 47.5mm L 257mm An 28mm H 45mm brida redonda empalme conector Faston 6,3mm resistencia de inmersión tubo ø 6.3mm H1 11mm H2 34mm longitud de empalme 28mm		
Para modelos:	KD100, KD100A, KD100PSD, KD130, KD130A, KD130E, KD130EAT, LP151		
accesorios para	415269		
	código	510408	referencia 3152650
	junta tórica EPDM espesor 5.34mm int.ø 47mm UE 1 pzs		
	código	510562	referencia —
	junta tórica silicona espesor 5.34mm int.ø 47mm UE 1 pzs		
	código	520235	referencia —
	brida tres orificios dist. del agujero 70.5mm ø perforación 6.5mm int.ø 53.5mm		
	código	520236	referencia —
	brida para resistencia int.ø 50mm ø ext. 90mm agujero ø 6.5mm 3 orificios		
	código	550002	referencia 3113780
	estribo de fijación H 10mm L 21mm An 10mm agujero ø 6.5mm para resistencia		
	código	550362	referencia —
	brida ciega ø 64mm montaje ø 47.5mm		

1			
código	415263	referencia	32G3390
descripción	resistencia 4500W 230V espirales 3 montaje ø 47.5mm L 375mm An 38mm H 46mm brida redonda empalme conector Faston 6,3mm resistencia de inmersión tubo ø 6.3mm ø casquillo portasondas 7mm casquillo portasondas 1 longitud casquillo portasondas 240mm casquillo termostato no ajustado		
accesorios para	415263		
	código	510408	referencia 3152650
	junta tórica EPDM espesor 5.34mm int.ø 47mm UE 1 pzs		
	código	520235	referencia —
	brida tres orificios dist. del agujero 70.5mm ø perforación 6.5mm int.ø 53.5mm		
	código	520236	referencia —
	brida para resistencia int.ø 50mm ø ext. 90mm agujero ø 6.5mm 3 orificios		
	código	521012	referencia —
	junta grafito ø ext. 15mm int.ø 5mm espesor 1.2mm UE 1 pzs		
	código	550002	referencia 3113780
	estribo de fijación H 10mm L 21mm An 10mm agujero ø 6.5mm para resistencia		

accesorios para	415263		
	código	550362	referencia —
	brida ciega ø 64mm montaje ø 47.5mm		

con brida redonda ø 57,5mm

1			
código	415019	referencia	32G0220
descripción	resistencia 3000W 230V espirales 3 montaje ø 57.5mm L 338mm An 37mm H 41mm brida redonda empalme conector Faston 6,3mm resistencia de inmersión tubo ø 8.5mm longitud de empalme 27mm ø casquillo portasondas 7mm casquillo portasondas 1 longitud casquillo portasondas 300mm casquillo termostato no ajustado con brida tres orificios & junta tórica		
accesorios para	415019		
	código	550002	referencia 3113780
	estribo de fijación H 10mm L 21mm An 10mm agujero ø 6.5mm para resistencia		



1			
código	416598	referencia	32G1931
descripción	resistencia 4540W 400V espirales 3 L 312mm An 55mm H 48mm tubo ø 8.5mm ø casquillo portasondas 7mm longitud casquillo portasondas 290mm casquillo portasondas 1 empalme M4 resistencia de inmersión brida redonda montaje ø 57.5mm		
Para modelos:	31PIE6		
accesorios para	416598		
	código	550002	referencia 3113780
	estribo de fijación H 10mm L 21mm An 10mm agujero ø 6.5mm para resistencia		



1			
código	415264	referencia	3037760
descripción	resistencia 6000W 230V espirales 3 montaje ø 57.5mm L 480mm An 33mm H 42mm brida redonda empalme M5 resistencia de inmersión tubo ø 8.5mm longitud de empalme 19mm ø casquillo portasondas 7.5mm casquillo portasondas 1 longitud casquillo portasondas 268mm casquillo termostato no ajustado		
Para modelos:	KD85, KD85A, KD85E, KD85EA, KD85EAT, KD85EATS, KD85EPS, KD85EPSA, KD85PS, KD85PSA, KN1100, KN1100SD, KN11PSDD, KN800, KN800PSD, LP151, LP202, LP202HC, LP302, LP302HC, N100D, N100S, N100VD, N100VS, N38D, N38S, N42D, N42S, N42VD, N42VS, N50D, N50S, N50VD, N50VS, N66D, N66S, N66VD, N66VS, N70D, N70S, N70VD, N70VS, N85D, N85S, N85VD, N85VS		
repuestos para	415264		
	código	510409	referencia 3150430 3151960 37Q5260
	junta tórica EPDM espesor 5.34mm int.ø 56.52mm UE 1 pzs		
accesorios para	415264		
	código	550002	referencia 3113780
	estribo de fijación H 10mm L 21mm An 10mm agujero ø 6.5mm para resistencia		





			
código	415183	referencia	32G0770
descripción	resistencia 7000W 220V espirales 3 L 415mm An 41mm H 70mm tubo ø 8.5mm empalme M4 resistencia de inmersión brida redonda L1 265mm L2 150mm H1 25mm H2 55mm montaje ø 57.5mm		
accesorios para	415183		
	código	521103	referencia
			N/A
	tuerca rosca M4 H 3mm EC 7 latón UE 20 pzs		
	código	521104	referencia
			—
	arandela int.ø 4.3mm ø ext. 8mm espesor 0.5mm latón UE 20 pzs para rosca M4		
	código	550002	referencia
			3113780
	estribo de fijación H 10mm L 21mm An 10mm agujero ø 6.5mm para resistencia		
	código	560111	referencia
			—
	arandela int.ø 4.3mm ø ext. 9mm espesor 0.8mm inox UE 20 pzs DIN 125A para rosca M4		
	código	560131	referencia
			—
	tuerca hexagonal rosca M4 H 3.2mm EC 7 inox DIN/ISO DIN 934 / ISO 4032/8673 UE 20 pzs		

			
código	416599	referencia	32G1031 32G1160
descripción	resistencia 7000W 240V espirales 3 L 405mm An 42mm H 70mm tubo ø 8.5mm ø casquillo portasondas 7mm longitud casquillo portasondas 51mm casquillo portasondas 1 casquillo termostato descentrado racor termostato M9x1 empalme M4 resistencia de inmersión brida redonda marmita L1 250mm L2 155mm H1 30mm H2 40mm montaje ø 57.5mm		
Para modelos:	71PIE15, 71PIE15A, 91PIE15, 91PIE15A		
accesorios para	416599		
	código	550002	referencia
			3113780
	estribo de fijación H 10mm L 21mm An 10mm agujero ø 6.5mm para resistencia		





			
código	416600	referencia	32G2330
descripción	resistencia 7000W 400V espirales 3 L 415mm An 41mm H 84mm tubo ø 8.5mm ø casquillo portasondas 6.5mm longitud casquillo portasondas 51mm casquillo portasondas 1 casquillo termostato no ajustado empalme M4 longitud de empalme 12mm resistencia de inmersión brida redonda marmita L1 265mm L2 150mm H1 32mm H2 52mm montaje ø 57.5mm		
Para modelos:	191PI2E, 191PI2EA, 1A1PI2E, 1A1PI2EA, 1D1PI2E, 1D1PI2EA		
accesorios para	416600		
	código	550002	referencia
			3113780
	estribo de fijación H 10mm L 21mm An 10mm agujero ø 6.5mm para resistencia		

			
código	415265	referencia	32G3410
descripción	resistencia 9000W 230V espirales 3 montaje ø 57.5mm L 470mm An 35mm H 41mm brida redonda empalme M5 resistencia de inmersión tubo ø 8.5mm longitud de empalme arriba centrado no ajustado ø casquillo portasondas 7.5mm casquillo portasondas 1 longitud casquillo portasondas 295mm		
Para modelos:	KD100, KD100A, KD100PSD, KD130, KD130A, KD130E, KD130EAT, LP202, LP202HC, LP302, LP302HC, LP402, LP402HC, LP402V, LPG300, N100D, N100S, N100VD, N100VS, N38D, N38S, N42D, N42S, N42VD, N42VS, N50D, N50S, N50VD, N50VS, N66D, N66S, N66VD, N66VS, N70D, N70S, N70VD, N70VS, N85D, N85S, N85VD, N85VS		
repuestos para	415265		
	código	510409	referencia
			3150430 3151960 37Q5260
	junta tórica EPDM espesor 5.34mm int.ø 56.52mm UE 1 pzs		
accesorios para	415265		
	código	550002	referencia
			3113780
	estribo de fijación H 10mm L 21mm An 10mm agujero ø 6.5mm para resistencia		



			
código	415011	referencia	32g0500
descripción	resistencia 3000W 230V espirales 1 rosca 1¼" L 285mm An 24mm H 20mm tubo ø 6.5mm empalme M4 resistencia de inmersión longitud de empalme 26mm brida roscada EC 54		
accesorios para	415011		
	código	510405	referencia
			N/A
	junta plana fibra ø ext. 56mm int.ø 42mm espesor 2mm para rosca 1¼" UE 1 pzs		
	código	520232	referencia
			—
	tuerca rosca 1¼" H 5mm latón niquelado EC 47 UE 1 pzs		
	código	528021	referencia
			—
	junta plana PTFE ø ext. 53mm int.ø 42.5mm espesor 3mm UE 1 pzs núm. Ref. 12001/02286 para Astoria/Aurora/Brasilia/Wega		

			
código	417167	referencia	32G0170
descripción	resistencia 4500W 230V espirales 3 rosca 2" L 300mm An 37mm H 37mm tubo ø 8.5mm empalme M4 resistencia de inmersión longitud de empalme 65mm		
repuestos para	417167		
	código	510407	referencia
			—
	junta plana fibra ø ext. 78mm int.ø 60mm espesor 2mm para resistencia para rosca 2" UE 1 pzs		



			
código	416261	referencia	32G2590
descripción	resistencia 3000W 230V espirales 1 L 358mm An 32mm H 34mm H2 37mm rosca M10x1 distancia de sujeción 26mm tubo ø 6.5mm empalme conector Faston 6,3mm sujeción 2 orificios resistencia de inmersión		
Para modelos:	LC100, LC100-VERS.2001, LC130, LC130-VERS.2001, LC80, LF50, LF50E		
accesorios para	416261		
	código	510416	referencia —
	junta plana fibra ø ext. 19mm int.ø 10.5mm espesor 1.5mm para rosca M10 UE 1 pzs		
	código	510893	referencia —
	junta tórica EPDM espesor 2.62mm int.ø 9.92mm UE 1 pzs		
	código	520231	referencia —
	tuerca rosca M10x1 H 6mm EC 14 acero zincado UE 1 pzs		
	código	521129	referencia —
	tuerca rosca M10 H 6mm inox EC 17 UE 1 pzs DIN/ISO DIN 439		

resistencias circulación de aire

			
código	418102	referencia	32G1701
descripción	resistencia 16400W 230V espirales 3 int.ø 441mm ø ext. 458mm L 492mm H 143mm L1 34mm B1 104mm H1 128mm H2 115mm longitud brida 142mm anchura brida 25mm dist. del agujero 63mm empalme M6x1 tubo ø 8.5mm resistencia circulación de aire agujero ø 6mm brida rectangular		
Para modelos:	BX101E, BX101E-VERS.122013, FC101E, FC101E, FCV101E, FCV101EDM, FCV101EDM-UL, FCV101EDS, FCV101EDS-UL, FCV101E-UL, FCV141E, FCV141EDM, FCV141EDS, FCV72EDM-UL, FCV72EDS-UL, FCV72E-UL, FM1011E1, FM1011E1-VERS.2006, FM1011E2, FM1011E2-VERS.2006, FM1011E3, FM1011E3-VERS.2006, FM2011E2-VERS.2006, FM2011E3-VERS.2006, FM721E1, FM721E1-VERS.2006, FM721E2, FM721E2-VERS.2006, FM721E3, FM721E3-VERS.2006, FX101E1, FX101E1R, FX101E2, FX101E2C, FX101E2R, FX101E3, FX101E3C, FX101E3R, FX10E2CR, FX10E3CR, FX201E2, FX201E2P, FX201E3, FX201E3P		
accesorios para	418102		
	código	699165	referencia 3332550
	junta L 142mm An 25mm D1 ø 6.5mm D2 ø 12mm dist. del agujero 17mm 9 orificios grafito espesor 2mm		



			
código	418103	referencia	32G1711
descripción	resistencia 24000W 400V espirales 3 int.ø 518mm ø ext. 535mm L 590mm H 143mm L1 38mm B1 104mm H1 120mm H2 23mm longitud brida 142mm anchura brida 25mm dist. del agujero 125mm empalme M6 tubo ø 8.5mm resistencia circulación de aire agujero ø 6mm brida rectangular		
Para modelos:	FC1221E, FC241E, FCV241E, FCV241EDM, FCV241EDS, FCV401EDM, FM1221E1, FM1221E1-VERS.2006, FM1221E2, FM1221E2-VERS.2006, FM1221E3, FM1221E3-VERS.2006, FM2021E1, FM2021E2, FM2021E2-VERS.2006, FM2021E3, FM2021E3-VERS.2006		
accesorios para	418103		
	código	699165	referencia 3332550
	junta L 142mm An 25mm D1 ø 6.5mm D2 ø 12mm dist. del agujero 17mm 9 orificios grafito espesor 2mm		

			
código	419175	referencia	32G1550
descripción	resistencia 2400W 230V espirales 1 int.ø 190mm ø ext. 210mm sujeción 2 orificios empalme M4 tubo ø 8.5mm rosca 1/4" armario caliente		
Para modelos:	A12A1E, A12B1E, A12B2E, A12M1E, A12Z1E, A12Z2E, A14A1E, A14B1E, A14B2E, A14M1E, A14Z1E, A14Z2E, A16A1E, A16B1E, A16B2E, A16M1E, A16Z1E, A16Z2E, A18A1E, A18B1E, A18B2E, A18M1E, A18Z1E, A18Z2E, A20A1E, A20B1E, A20B2E, A20M1E, A20Z1E, A20Z2E, ACBM, ACBM218, ACPN, ACPN218, AJ12AE, AJ12ME, AJ14AE, AJ14ME, AJ16AE, AJ16ME, SL14CPN, SL14CVB, SL21CPN, SL21CVB		

			
código	418099	referencia	32G0430
descripción	resistencia 2800W 230V espirales 1 int.ø 217mm ø ext. 230mm L 249mm H 72mm L1 11mm B1 68mm H1 11mm H2 41mm longitud brida 142mm anchura brida 25mm dist. del agujero 63mm empalme conector Faston 6,3mm longitud de empalme 73mm tubo ø 6.3mm resistencia circulación de aire agujero ø 6mm brida rectangular		
Para modelos:	FCV3EM		



			
1			
código	418100	referencia	32G1940
descripción	resistencia 4150W 230V espirales 3 int.ø 214mm ø ext. 226mm L 248mm H 70mm L1 15mm B1 103mm H1 5mm H2 65mm longitud brida 142mm anchura brida 25mm dist. del agujero 62mm empalme conector Faston 6,3mm tubo ø 6.3mm resistencia circulación de aire agujero ø 6mm brida rectangular		
Para modelos:	FCV4E, FCV4EDS, FCV4EM, FM423E1, FM423E2		

			
1			
código	418101	referencia	32G1691
descripción	resistencia 8700W 230V espirales 3 int.ø 317mm ø ext. 333mm L 375mm H 100mm L1 42mm B1 105mm H1 82mm H2 18mm longitud brida 142mm anchura brida 25mm dist. del agujero 63mm empalme M6 longitud de empalme 26mm tubo ø 8.5mm resistencia circulación de aire agujero ø 6mm brida rectangular		
Para modelos:	FC611E, FC61E, FCV61E, FCV61EDM, FCV61EDM-UL, FCV61EDS, FCV61EDS-UL, FCV61E-UL, FM611E1, FM611E1-VERS.2006, FM611E2, FM611E2-VERS.2006, FM611E3, FM611E3-VERS.2006		
accesorios para	418101		
		código	699165
		referencia	3332550
	junta L 142mm An 25mm D1 ø 6.5mm D2 ø 12mm dist. del agujero 17mm 9 orificios grafito espesor 2mm		

			
1			
código	419261	referencia	3116030
descripción	resistencia 9500/10400W 230/240V espirales 3 int.ø 320mm ø ext. 337mm L 380mm H 148mm L1 40mm B1 105mm H1 20mm H2 120mm longitud brida 142mm anchura brida 25mm dist. del agujero 18mm empalme M6x1 longitud de empalme 85mm tubo ø 8.5mm resistencia circulación de aire brida horno a vapor combinado		
Para modelos:	BX61E, BX61E-VERS.122013, FX61E1, FX61E1R, FX61E2, FX61E2C, FX61E2CR, FX61E2CR-VERS.032014, FX61E2C-VERS.032014, FX61E2R, FX61E2R-VERS.032014, FX61E2-VERS.032014, FX61E3, FX61E3C, FX61E3CR, FX61E3CR-VERS.022014, FX61E3C-VERS.022014, FX61E3R, FX61E3R-VERS.022014, FX61E3-VERS.022014		

			
1			
código	415737	referencia	32G1280
descripción	resistencia 2500W 230V espirales 1 L 655mm An 120mm L1 30mm L2 625mm B2 90mm longitud brida 70mm anchura brida 22mm dist. del agujero 56mm longitud de empalme 100mm empalme M4 tubo ø 6.3mm agujero ø 5.5mm B1 30mm brida rectangular resistencia circulación de aire espirales 2		

			
1			
código	419222	referencia	3115001
descripción	resistencia 27000/29000W 400/415V L 590mm An 545mm H 140mm espirales 3 longitud del cable mm		
Para modelos:	BX122E, BX122E-VERS.122013, FX122E1, FX122E2, FX122E2C, FX122E2T, FX122E2T-VERS.032014, FX122E3, FX122E3C, FX122E3T, FX122E3T-VERS.022014, FX12E3CT, FX12E3CT-VERS.022014, FX202E2, FX202E2-VERS.032014, FX202E3, FX202E3-VERS.022014		

			
1			
código	415736	referencia	32G1360
descripción	resistencia 3500W 230V espirales 1 L 655mm An 125mm L1 30mm L2 625mm B2 88mm longitud brida 70mm anchura brida 22mm dist. del agujero 56mm longitud de empalme 97mm empalme M4 tubo ø 6.25mm agujero ø 5mm B1 30mm brida rectangular resistencia circulación de aire espirales 2 distancia de sujeción 58mm		

resistencias radiantes

a 1 circuito

			
1			
código	490025	referencia	3080080
descripción	resistencia radiante ø 200mm 1700W 230V espirales 1 regulación de energía con avisador de temperatura con resistencia en espiral empalmes 2+2 tipo de empalme conector Faston 6,3mm EGO		
Para modelos:	OG0PEVTR, 1G0PEVTR, 6VTR, 6VTR2		



a 2 circuitos



1

código	490139	referencia	3080070
descripción	resistencia radiante \varnothing 250mm 2500W 230V espirales 2 regulación de energía con avisador de temperatura potencia parcial 1000W con resistencia ondulada empalmes 3+2 tipo de empalme conector Faston 6,3mm EGO		



1

código	490071 ¹	referencia	32G1210 32G1211
descripción	placa de cocción medidas 300x300mm 4000W 230V con borde integrado empalme 4 bornes de rosca protector presente cuadrado		
Para modelos:	070E, 071E, 08WPE4V, 090E, 090PE4, 091E, 190PE4, 71E		

¹con protector

placas de cocción

cuadrada y rectangular

con borde integrado



1

código	490068 ¹	referencia	32G2860
descripción	placa de cocción medidas 220x220mm 2600W 400V con borde integrado empalme 4 bornes de rosca protector presente cuadrado		
Para modelos:	0G0PE2, 0G1PE2, 1G0PE2, 1G1PE2, 1G1PE2E, 1G1PE2EV, 2G0PE2, 2G1PE2E, 2G1PE2EV		

¹con protector

1

código	490074 ¹	referencia	32G0940 32G1080
descripción	placa de cocción medidas 300x300mm 4000W 400V con borde integrado empalme 4 bornes de rosca protector presente cuadrado		
Para modelos:	04WPE4V, 070E, 071E, 08WPE4V, 090E, 090PE4, 091E, 0A0PE4, 0D0PE4, 190PE4, 191PE4E, 1A0PE4, 1A1PE4E, 1A1PEFTE, 1D0PE4, 1D1PE4E, 71E		

¹con protector

1

código	490056 ¹	referencia	32G1201
descripción	placa de cocción medidas 300x300mm 3000W 230V con borde integrado empalme 4 bornes de rosca protector presente cuadrado		
Para modelos:	070E, 071E, 090E, 091E, 71E		

¹con protector

redondas

con borde integrado

para cocinas domésticas y industriales



1

código	490016	referencia	32G0030
descripción	placa de cocción \varnothing 180mm 2000W 230V empalme 4 bornes de rosca con borde de 8 mm		
Para modelos:	030E, 031E, 0G0PE1, 1G0PE1, 1G1PE1E, 1G1PE1EV, 2G0PE1, 2G1PE1E, 2G1PE1EV, 31TCE, 32TCE		



1

código	490017	referencia	32G0290 32G1320
descripción	placa de cocción \varnothing 180mm 2000W 400V empalme 4 bornes de rosca con borde de 8 mm		
Para modelos:	030E, 031E, 0G0PE1, 1G0PE1, 1G1PE1E, 1G1PE1EV, 2G0PE1, 2G1PE1E, 2G1PE1EV, 31TCE, 32TCE		



1

código	490073	referencia	32G0930 32G1090
descripción	placa de cocción medidas 300x300mm 3000W 400V con borde integrado empalme 4 bornes de rosca protector no cuadrado		
Para modelos:	070E, 071E, 090E, 091E, 71E		



1

código	490020	referencia	32G0020
descripción	placa de cocción ø 220mm 2600W 230V empalme 4 bornes de rosca con borde de 8 mm		
Para modelos:	030E, 031E, 0G0PE1, 1G0PE1, 1G1PE1E, 1G1PE1EV, 2G0PE1, 2G1PE1E, 2G1PE1EV, 31TCE, 32TCE		
accesorios para	490020		
	código	referencia	—
	550796		
	placa de sujeción para placa ø220mm		



1

código	490021	referencia	32G0300 32G1330
descripción	placa de cocción ø 220mm 2600W 400V empalme 4 bornes de rosca con borde de 8 mm		
Para modelos:	030E, 031E, 0G0PE1, 1G0PE1, 1G1PE1E, 1G1PE1EV, 2G0PE1, 2G1PE1E, 2G1PE1EV, 31TCE, 32TCE		

reguladores de energía

EGO

a 1 circuito



1

código	380015	referencia	32Z0170 32Z0171
descripción	regulador de energía 230V 13A circuito simple sentido de rotación derecho eje ø 6x4,6mm eje L 23mm rosca de sujeción M4 liberación potencia 6-100% N° 50.57021.010		
Para modelos:	06WBR3E, 08WGREV, 090SPE, 0G0SPE, 0G1BR3E, 190GRE, 191BR1E, 191BR2E, 191BR2EA, 1A1BR1E, 1A1BR2E, 1A1BR2EA, 1D1BR1E, 1D1BR2E, 1D1BR2EA, 1G0GRE, 1G1BR3E, 291BR1E, 291BR2E, 291BR2EA, 291PI3E, 2A1BR1E, 2A1BR2E, 2A1BR2EA, 2A1PI3E, 2D1BR1E, 2D1BR2E, 2D1BR2EA, FC1011E, FC1011G, FC1221E, FC1221G, FC611E, FC611G, FMS, FMSX		

a 2 circuitos



1

código	380027	referencia	3008300
descripción	regulador de energía EGO 230V 13A doble circuito sentido de rotación derecho eje ø 6x4,6mm eje L 23mm rosca de sujeción M4 liberación potencia 6-70% N° 50.55021.100		
Para modelos:	04WVT3RV, 090VTR, 0G0PEVTR, 190VTR, 1G0PEVTR, 6042520, 6042530, 6043590, 6VTR2		

accesorios

potencios



1

código	110117	referencia	36M0750
descripción	potencio reg. de energía 1-3 T máx°C ø 60mm eje ø 6x4,6mm parte plana arriba negro		
repuestos para	110117		
	código	referencia	—
	112495		
	muelle de potencio L 10.5mm An 8.5mm UE 1 pzs		

termostatos

termostatos de superficie

termostatos de superficie de seguridad



1

código	390480	referencia	32V7250
descripción	termómetro de superficie de seguridad dist. del agujero 23.8mm temp. desconexión 105°C 1NC 1 polos 16A empalme F6,3 sujeción 2 orificios		



1

código	390233	referencia	32V7250 32Z8270
descripción	termómetro de superficie de seguridad dist. del agujero 24mm temp. desconexión 110°C 1NC 1 polos 16A empalme F6,3 sujeción 2 orificios sin soporte		
accesorios para	390233		
	código	referencia	—
	504736		
	soporte para termostato de contacto		

Continúa en la página siguiente



accesorios para	390233			
	código	550388	referencia	—
	soporte para termostato de contacto distancia de sujeción 24.5mm fijación ø 3.8			

termostatos de superficie



1			
código	375927	referencia	3093940
descripción	termostato de contacto dist. del agujero 23.5mm temp. desconexión 50°C 1NO 10A empalme F6,3		
Para modelos:	04WPEBV, 08WPEBV, 08WTPEV, 090PEB, 091FR7G, 091PEB, 190PEB, 190TPE, 191PEB, 191TPE, 6BM, 6BR, 6CP, 6FR, 6FTL, 6FTR, 6PC, 6VTR		



1			
código	390439	referencia	3008880
descripción	termostato de contacto dist. del agujero 23.5mm temp. desconexión 70°C 1NC 10A 250V empalme F6,3		
Para modelos:	04WPE4V, 08WPE4V, 090PE4, 091FR11, 091FR7G, 190PE4, 191FR2I, 191FR4ED, 191PE4E, 6BM, 6BR, 6CP, 6FR, 6FTL, 6FTR, 6PC, 6VTR		

termostatos de control y seguridad

EGO

termostatos de regulación

serie 51._



1				
código	390033	referencia	32Z0410	
descripción	termóstato T máx 93°C margen de trabajo 30-93°C 1 polos 1NO 15A sonda ø 20/23,5mm sonda L 11mm capilar 900mm aislamiento del capilar 800mm prensaestopas eje ø 6x4,6mm eje L 25mm posición del eje arriba ángulo de rotación 270° interruptor auxiliar 2NO material de bulbo inox con botón sensor			
Para modelos:	030BME, 030EBM, 031BME, 031EBM, 0G0BME, 1G0BME, A12A1E, A12B1E, A12B2E, A12M1E, A12Z1E, A12Z2E, A14A1E, A14B1E, A14B2E, A14M1E, A14Z1E, A14Z2E, A16A1E, A16B1E, A16B2E, A16M1E, A16Z1E, A16Z2E, A18A1E, A18B1E, A18B2E, A18M1E, A18Z1E, A18Z2E, A20A1E, A20B1E, A20B2E, A20M1E, A20Z1E, A20Z2E, ACBM, ACBM218, ACPN, ACPN218, AJ12AE, AJ12ME, AJ14AE, AJ14ME, AJ16AE, AJ16ME, AJ18AE, AJ18ME, AJ20AE, AJ20ME...(Otros modelos se puede ver en la tienda web)			
accesorios para	390033			
	código	510167	referencia	3150270 315Q270
	junta para termostato ø ext. 41mm int.ø 18mm UE ANGELO PO/ ZANUSSI pzs núm. Ref. 3150270/66717			

serie 55.10/19_

E-G-O



1			
código	375345	referencia	32Z9380
descripción	termóstato T máx 150°C margen de trabajo ajuste fijo 150°C 1 polos 1NO 16A sonda ø 6mm sonda L 74mm capilar 900mm aislamiento del capilar 900mm prensaestopas eje Lmm posición del eje° posición del eje		
Para modelos:	04WBMVEV, 090BM1E, 0A0BME, 0B0BME, 0D0BME, 6040110, 6042680		

E-G-O



1			
código	375844	referencia	32Z2940
descripción	termóstato T máx 182°C margen de trabajo 100-180°C 1 polos 1NO 16A sonda ø 11mm sonda L 28mm capilar 850mm aislamiento del capilar 800mm prensaestopas eje ø 6x4,6mm eje L 23mm posición del eje arriba ángulo de rotación 270° sonda roscada rosca sonda M14x1		

E-G-O



1			
código	375395	referencia	32V4540
descripción	termóstato T máx 182°C margen de trabajo 95-180°C 1 polos 1NO 16A sonda ø 6mm sonda L 133mm capilar 870mm aislamiento del capilar mm prensaestopas M9x1 eje ø 6x4,6mm eje L 13mm posición del eje arriba ángulo de rotación 270° 250V		
Para modelos:	0M0FR1E, 1M0FR2E		



código	375922	referencia	3168460
descripción	termóstato T máx 185°C margen de trabajo 101-185°C 1 polos 1NO 16A sonda ø 6mm sonda L 133mm capilar 870mm aislamiento del capilar 520mm prensaestopas M10x1 eje ø 6x4,6mm eje L 23mm posición del eje arriba		
Para modelos:	091FR11, 091FR11-VERS.032012, 191FR21, 191FR21-VERS.032012		



código	375437	referencia	32Z0210
descripción	termóstato T máx 324°C margen de trabajo 66-324°C 1 polos 1NO 16A sonda ø 4mm sonda L 124mm capilar 1470mm aislamiento del capilar 900mm prensaestopas eje ø 6x4,6mm eje L 23mm posición del eje arriba ángulo de rotación 270°		



código	375631	referencia	32Z5820
descripción	termóstato T máx 249°C margen de trabajo 55-249°C 1 polos 1NO 16A sonda ø 3.1mm sonda L 226mm capilar 1270mm aislamiento del capilar 850mm prensaestopas 3/8"-M8x1 eje ø 6x4,6mm eje L 23mm posición del eje arriba ángulo de rotación 318°		
Para modelos:	FC101, FC1011E, FC1011G, FC101E, FC1221E, FC1221G, FC241, FC241E, FC241G, FC61, FC611E, FC611G, FC61E, FCV101, FCV101-CSA, FCV101E, FCV101E-UL, FCV141, FCV141-CSA, FCV141E, FCV241, FCV241E, FCV241E-UL, FCV241G, FCV241G-CSA, FCV3EM, FCV4EM, FCV61, FCV61-CSA, FCV61E, FCV61E-UL, FCV72E-UL		



código	375643	referencia	32Z2371
descripción	termóstato T máx 330°C margen de trabajo ajuste fijo 330°C 1 polos 1NC 16A sonda ø 3mm sonda L 219mm capilar 900mm aislamiento del capilar 900mm prensaestopas		
Para modelos:	030EBM, 031EBM, 0G0BME, 0G0BME-VERS.032008, 1G0BME, 1G0BME-VERS.032008		



código	390068	referencia	32Z0610
descripción	termóstato T máx 269°C margen de trabajo 55-269°C 1 polos 1CO 16A sonda ø 3.1mm sonda L 219mm capilar 1280mm aislamiento del capilar 1270mm prensaestopas eje ø 6x4,6mm eje L 23mm posición del eje arriba ángulo de rotación 318°		



código	390037	referencia	32Z0180
descripción	termóstato T máx 54°C margen de trabajo ajuste fijo 54°C 1 polos 1NC 16A sonda ø 20/23,5mm sonda L 11mm capilar 900mm aislamiento del capilar 850mm prensaestopas		



código	375845	referencia	32Z2160
descripción	termóstato T máx 54°C margen de trabajo ajuste fijo 54°C 1 polos CO sonda ø 20/23,5mm sonda L 11mm capilar 1600mm aislamiento del capilarmm prensaestopas con botón sensor		

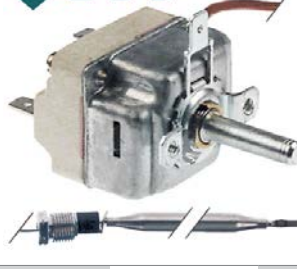

código	375632	referencia	32Z5880
descripción	termóstato T máx 90°C margen de trabajo 30-90°C 1 polos 1CO 16A sonda ø 6mm sonda L 130mm capilar 1300mm aislamiento del capilar 850mm prensaestopas M10x1 eje ø 6x4,6mm eje L 23mm posición del eje arriba ángulo de rotación 270°		



código	375215	referencia	32Z2430
descripción	termóstato T máx 65°C margen de trabajo ajuste fijo 65°C 1 polos 1CO 16A sonda ø 6mm sonda L 130mm capilar 900mm aislamiento del capilar 900mm prensaestopas eje Lmm posición del eje		
Para modelos:	F60PR, F60T, F80P, F80PR, L100, L40, L40S, L60, L80		



código	390040	referencia	32V0200
descripción	termóstato T máx 90°C margen de trabajo 30-90°C 1 polos 1CO 16A sonda ø 6mm sonda L 130mm capilar 2040mm aislamiento del capilar 1940mm prensaestopas eje ø 6x4,6mm eje L 23mm posición del eje arriba ángulo de rotación 270° material de bulbo inox		
Para modelos:	F60P, F60PR, F60T, F80P, F80PR, L45		



código	390003	referencia	32Z0450	
descripción	termóstato T máx 90°C margen de trabajo 30-90°C 1 polos 1CO 16A sonda ø 15mm sonda L 22.5mm capilar 1700mm aislamiento del capilarmm prensaestopas eje ø 6x4,6mm eje L 16mm posición del eje arriba posición del eje ángulo de rotación 270° con botón sensor			
accesorios para	390003			
	código	510165	referencia	—
	junta para termostato ø ext. 27mm int.ø 11mm espesor 8.5mm			

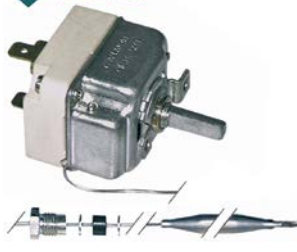

código	390032	referencia	32Z0160 32Z5880
descripción	termóstato T máx 90°C margen de trabajo 30-90°C 1 polos 1CO 16A sonda ø 6mm sonda L 130mm capilar 2500mm aislamiento del capilarmm prensaestopas M10x1 eje ø 6x4,6mm eje L 23mm posición del eje arriba ángulo de rotación 270° material de bulbo inox		
Para modelos:	FC101, FC1011E, FC1011G, FC101E, FC1221E, FC1221G, FC241, FC241E, FC241G, FC61, FC611E, FC611G, FC61E, FCV101, FCV101-CSA, FCV101E, FCV101E-UL, FCV141, FCV141-CSA, FCV141E, FCV241, FCV241E, FCV241E-UL, FCV241G, FCV3EM, FCV401DM, FCV401EDM, FCV401EDM-UL, FCV4EM, FCV61, FCV61-CSA, FCV61E, FCV61E-UL, FCV72E-UL, L100, L40, L40S, L60, L80		

serie 55.34_

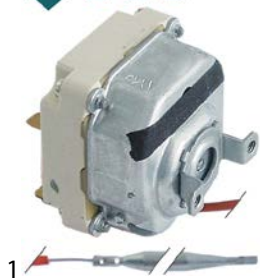

código	375343	referencia	32Z9210
descripción	termóstato T máx 160°C margen de trabajo ajuste fijo 160°C 3 polos 3NC 16A sonda ø 6mm sonda L 74mm capilar 900mm aislamiento del capilar 900mm prensaestopas		
Para modelos:	190BM2E, 1A0BME, 1D0BME		



código	375038	referencia	32Z2560
descripción	termóstato T máx 300°C margen de trabajo 50-300°C 3 polos 3NO 16A sonda ø 6mm sonda L 79mm capilar 1740mm aislamiento del capilar 800mm prensaestopas eje ø 6x4,6mm eje L 23mm posición del eje arriba ángulo de rotación 270°		
Para modelos:	191FAAE, 191FAE, 191PE4E, 1A1PE4E, 1A1PEFTE, 1AIFBE, 1D1PE4E, 1DIFBE, 71E, 71GE, 71GEGG, FS30E		

accesorios para 375038



código	110123	referencia	—
descripción	pomo termóstato T máx 300°C ø 50mm eje ø 6x4,6mm parte plana arriba negro margen de trabajo 50-300°C ángulo de rotación 270°		

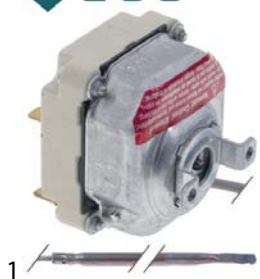

código	375991	referencia	3110640
descripción	termóstato T máx 560°C margen de trabajo ajuste fijo 560°C 3 polos 3NC 16A sonda ø 3.9mm sonda L 225mm capilar 1150mm aislamiento del capilar 600mm prensaestopas		
Para modelos:	04WPBEV, 08WPBEV, 08WTPPEV, 090PEB, 091PEB, 190PEB, 190TPE, 191PEB, 191TPE, 6042610, 6042630, 6044340, 6044350		

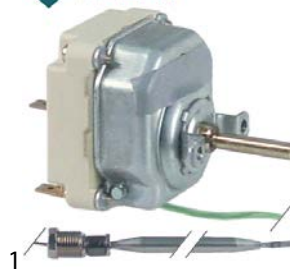

código	375411	referencia	32z0130
descripción	termóstato T máx 93°C margen de trabajo 30-93°C 3 polos 3NO 16A sonda ø 6mm sonda L 129mm capilar 1480mm aislamiento del capilar 1100mm prensaestopas M10x1 eje ø 6x4,6mm eje L 23mm posición del eje arriba ángulo de rotación 270°		



código	375836	referencia	3001550
descripción	termóstato T máx 95°C margen de trabajo ajuste fijo 95°C 3 polos 1CO/2NC 16A sonda ø 3.1mm sonda L 226mm capilar 880mm aislamiento del capilar 880mm prensaestopas		
Para modelos:	08WGREV, 190GRE, 1G0GRE, 1G1PE1E, 1G1PE1EV, 1G1PE2E, 1G1PE2EV, 2G1PE1E, 2G1PE1EV, 2G1PE2E, 2G1PE2EV		

termostatos de seguridad

serie 55.10/19_

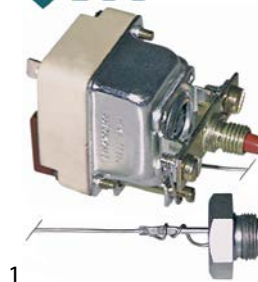

código	375166	referencia	31Z7990 32Z3340 32Z8000
---------------	--------	-------------------	-------------------------------

descripción termóstato de seguridad temp. desconexión 230°C 1 polos 0.5A sonda ø 11mm sonda L 16.5mm capilar 850mm aislamiento del capilar 850mm prensaestopas bulbo sonda roscada rosca sonda M14x1

Para modelos: 30F, 30FS, 70F, 71F

accesorios para 375166



código	521133	referencia	—
descripción	tuerca rosca M14x1,5 H 6mm EC 19 acero zincado UE 1 pzs		



código	532520	referencia	3150390
descripción	junta tórica silicona espesor 2.62mm int.ø 15.08mm UE 1 pzs		

Continúa en la página siguiente



accesorios para	375166			
	código	550261	referencia	—
	tuerca rosca M14x1 H 4mm EC 19 inox UE 1 pzs			

serie 55.32_



código	375438	referencia	3014260 3014261
descripción	termóstato temp. desconexión 156°C 3 polos 20A sonda ø 6mm sonda L 87mm capilar 1490mm aislamiento del capilar 1350mm prensaestopas eje ø 6x4,6mm bulbo		
Para modelos:	04WCP1EM, 091CP1E, 0A1CP1E, 0D1CP1E, 0G1CP1E, 0G1CP1EC, 0G1CP1E-VERS.2004, 10CP1EA, 12CP1EA, 18CP2EA, 6040090, 6040310, 6043250, 6043470, 6043850, 6043980, PIER06HD, PIER15HD		



código	375474	referencia	3111950 32Z5511
descripción	termostato de seguridad T máx 340°C temp. desconexión 340°C 2 polos 1NC/1CO 1x20/1x0,5A sonda ø 4mm sonda L 120mm capilar 1300mm aislamiento del capilar 900mm prensaestopas bulbo		
Para modelos:	FC101, FC1011E, FC1011G, FC101E, FC1221E, FC1221G, FC241, FC241E, FC241G, FC61, FC611E, FC611G, FC61E, FCV101, FCV101DM, FCV101DS, FCV101E, FCV101EDM, FCV101EDS, FCV141, FCV141DM, FCV141DS, FCV141E, FCV141EDM, FCV141EDS, FCV241, FCV241DM, FCV241DS, FCV241E, FCV241EDM, FCV241EDS, FCV241G, FCV241G-CSA, FCV241GDM, FCV241GDS, FCV3EM, FCV401DM, FCV401EDM, FCV4EM, FCV61, FCV61DM, FCV61DS, FCV61E, FCV61EDM, FCV61EDS, FM1011E1, FM1011E1-VERS.2006, FM1011E2, FM1011E2-VERS.2006, FM1011E3...(Otros modelos se puede ver en la tienda web)		



código	375308	referencia	32Z9620 32Z9621
descripción	termostato de seguridad temp. desconexión 135°C 3 polos 0.5A sonda ø 11mm sonda L 27.5mm capilar 1000mm aislamiento del capilar 960mm prensaestopas bulbo sonda rosca rosca sonda M14x1		
Para modelos:	191PI1G, 191PI1GA, 191PI2G, 191PI2GA, 1A1PI1G, 1A1PI1GA, 1D1PI1G, 1D1PI1GA, 1G1PI1G, 291PD3G, 291PI3G, 31PI6, 71PI10, 71PI10A, 91PI10, 91PI10A		



código	375208	referencia	32V398
descripción	termostato de seguridad temp. desconexión 139°C 3 polos 2x20/1x0,5A sonda ø 6mm sonda L 77mm capilar 890mm aislamiento del capilar mm prensaestopas M9x1 bulbo inox		



código	375209	referencia	32V3980 32Z2011
descripción	termostato de seguridad temp. desconexión 140°C 3 polos 20A sonda ø 6mm sonda L 89mm capilar 900mm aislamiento del capilar 900mm prensaestopas bulbo inox		
Para modelos:	191CP1GA, 1A1CP1GA, 1A1PI2G, 1A1PI2GA, 1D1CP1GA, 1D1PI2G, 1D1PI2GA, 291PD3G, 291PI3G, 2A1PD3G, 2A1PI3G, 2D1PI3G, F60P, F60PR, F60T, F80P, F80PR, L100, L40, L40S, L45, L60, L80		



código	375622	referencia	32V0320
descripción	termostato de seguridad temp. desconexión 147°C 1 polos 20A sonda ø 6mm sonda L 89mm capilar 900mm aislamiento del capilar 800mm prensaestopas bulbo		
Para modelos:	291PI3E, 2A1PI3E, MCF20E, MCF40E		



código	375290	referencia	32Z3631
descripción	termostato de seguridad temp. desconexión 240°C 3 polos 20A sonda ø 6mm sonda L 87mm capilar 2000mm aislamiento del capilar 1800mm prensaestopas bulbo inox		
Para modelos:	030FE, 030FE1, 030FE1B, 091FE28, 091FE28B, 30FES, 30FES2, 30FES2B, 70FE, 70FE1, 70FE1B, 70FES, 70FES2, 70FES2B, 71FE, 71FE2, 71FE2B		



código	390166	referencia	32Z2710
descripción	termostato de seguridad temp. desconexión 150°C 3 polos 20A sonda ø 6mm sonda L 87mm capilar 1490mm aislamiento del capilar 1250mm prensaestopas M9x1 bulbo inox		
Para modelos:	04WCP1EM, 0A1CP1E, 0D1CP1E, 0G1CP1E, 191PI2E, 191PI2EA, 1A1PI2E, 1A1PI2EA, 1D1PI2E, 1D1PI2EA, 1G1PI1E, 30CPSE, 31PIE6, 70CPE, 71PIE15, 71PIE15A, 90CPE, 91PIE15, 91PIE15A		



código	375841	referencia	32V4630 32Z0200 32Z7980
descripción	termostato de seguridad temp. desconexión 248°C 3 polos sonda ø 6mm sonda L 87mm capilar 1500mm aislamiento del capilar mm prensaestopas bulbo inox		
Para modelos:	0M0FR1E, 1M0FR2E		



código	375528	referencia	32V0460
descripción	termostato de seguridad temp. desconexión 200°C 1 polos 0.5A sonda ø 6mm sonda L 79mm capilar 900mm aislamiento del capilar 900mm prensaestopas bulbo inox		
Para modelos:	090BM1G, 0A0BMG, 0D0BMG, 190BM2G, 1A0BMG, 1D0BMG		



código	375292	referencia	32V0970
descripción	termostato de seguridad temp. desconexión 253°C 3 polos 20A sonda ø 6mm sonda L 79mm capilar 2000mm aislamiento del capilar 1800mm prensaestopas bulbo		
Para modelos:	0A1FR1E, 0A1FR1ED, 0D1FR1E, 0D1FR1ED, 1A1FR2E, 1A1FR2ED, 1D1FR2ED		



código	391040	referencia	32V6561
descripción	termostato de seguridad temp. desconexión 270°C 3 polos 3NC 16A sonda ø 6mm sonda L 79mm capilar 2050mm aislamiento del capilar 1700mm material de bulbo inox		
Para modelos:	04WFR3ED, 08WFR4ED, 091FR1E, 091FR1EA, 091FR1ED, 091FR1EX, 091FR3E, 091FR3ED, 091FR7G, 091FR7GS, 091FR7G-VERS.052012, 091FR7GX, 0A1FR1E, 0A1FR1ED, 0A1FR3E, 0A1FR3ED, 0D1FR1E, 0D1FR1ED, 0D1FR3E, 0D1FR3ED, 0G0FR3E, 0G0FR3ED, 191FR2E, 191FR2ED, 191FR4E, 191FR4ED, 1A1FR2E, 1A1FR2ED, 1A1FR4E, 1A1FR4ED, 1D1FR2ED, 1D1FR4E, 1D1FR4ED, 1G0FR4E, 6043840, 6043970		



código	375943	referencia	32Z5612
descripción	termostato de seguridad temp. desconexión 299°C 1 polos 20A sonda ø 4mm sonda L 123mm capilar 1500mm aislamiento del capilar 1400mm prensaestopas bulbo		
Para modelos:	06WFR3GD, 091FR1G, 091FR1GD, 091FR1I, 091FR1IA, 091FR1ID, 091FR1ID-VERS.052012, 091FR1I-VERS.032012, 091FR3G, 091FR3GD, 0A1FR1G, 0A1FR1GD, 0A1FR1GD-VERS.2004, 0A1FR1G-VERS.2004, 0A1FR3G, 0A1FR3GD, 0B1FR1G, 0B1FR1GD, 0D1FR1G, 0D1FR1GD, 0D1FR1GD-VERS.2004, 0D1FR1G-VERS.2004, 0D1FR3G, 0D1FR3GD, 0G1FR3G, 0G1FR3GD, 10WFR4GD, 191FR2G, 191FR2GD, 191FR2I, 191FR2ID, 191FR2ID-VERS.092012, 191FR2I-VERS.032012, 191FR4G, 191FR4GD, 1A1FR2G, 1A1FR2GD, 1A1FR2GD-VERS.2004, 1A1FR2G-VERS.2004, 1A1FR4G, 1A1FR4GD, 1D1FR2G, 1D1FR2GD, 1D1FR2GD-VERS.2004, 1D1FR2G-VERS.2004, 1D1FR4G, 1D1FR4GD, 1G1FR4G, 1G1FR4GD, 30F1...(Otros modelos se puede ver en la tienda web)		



código	375840	referencia	32V6560
descripción	termostato de seguridad temp. desconexión 270°C 3 polos 3NC 20A sonda ø 6mm sonda L 79mm capilar 2000mm aislamiento del capilar mm prensaestopas bulbo inox		
Para modelos:	04WFR3ED, 08WFR4ED, 091FR1E, 091FR1ED, 091FR3E, 091FR3ED, 0A1FR1E, 0A1FR1ED, 0A1FR3E, 0A1FR3ED, 0D1FR1E, 0D1FR1ED, 0D1FR3E, 0D1FR3ED, 0G0FR3E, 0G0FR3ED, 191FR2E, 191FR2ED, 191FR4E, 191FR4ED, 1A1FR2E, 1A1FR2ED, 1A1FR4E, 1A1FR4ED, 1D1FR2ED, 1D1FR4E, 1D1FR4ED, 1G0FR4E		



código	375220	referencia	32Z6790
descripción	termostato de seguridad temp. desconexión 330°C 3 polos 20A sonda ø 11mm sonda L 18.5mm capilar 900mm aislamiento del capilar 900mm prensaestopas bulbo sonda roscada rosca sonda M14x1		
Para modelos:	FCV4E, FCV4EDS		



código	375286	referencia	32Z5381 32Z5610
descripción	termostato de seguridad temp. desconexión 285°C 1 polos 0.5A sonda ø 4mm sonda L 120mm capilar 1500mm aislamiento del capilar 1500mm prensaestopas bulbo		
Para modelos:	06WFR3GD, 091FR1G, 091FR1GD, 091FR3G, 091FR3GD, 0A1FR1G, 0A1FR1GD, 0A1FR1GD-VERS.2004, 0A1FR1G-VERS.2004, 0A1FR3G, 0A1FR3GD, 0B1FR1G, 0B1FR1GD, 0D1FR1G, 0D1FR1GD, 0D1FR1GD-VERS.2004, 0D1FR1G-VERS.2004, 0D1FR3G, 0D1FR3GD, 0G1FR3G, 0G1FR3GD, 10WFR4GD, 191FR2G, 191FR2GD, 191FR4G, 191FR4GD, 1A1FR2G, 1A1FR2GD, 1A1FR2GD-VERS.2004, 1A1FR2G-VERS.2004, 1A1FR4G, 1A1FR4GD, 1D1FR2G, 1D1FR2GD, 1D1FR2GD-VERS.2004, 1D1FR2G-VERS.2004, 1D1FR4G, 1D1FR4GD, 1G1FR4G, 1G1FR4GD, 30F1, 30F1B, 30FS2, 30FS2B, 70F1, 70F1B, 71F2, 71F2B, 90F110B, 91F210...(Otros modelos se puede ver en la tienda web)		



código	375344	referencia	32Z1400
descripción	termostato de seguridad temp. desconexión 360°C 1 polos 0.5A sonda ø 4mm sonda L 120mm capilar 1500mm aislamiento del capilar 1500mm prensaestopas bulbo		
Para modelos:	031FT04, 031FT06, 070FT04, 070FT05, 071FT04, 071FT06, 08WFT-4GV, 08WFT6GV, 090FT04, 090FT05, 090FT4G, 090FT5G, 091FT04, 091FT06, 0A0FT1G, 0A0FT2G, 0A0FT4G, 0A0FT5G, 0B0FT1G, 0B0FT2G, 0B0FT4G, 0B0FT5G, 0D0FT1G, 0D0FT2G, 0D0FT4G, 0D0FT5G, 0G0FT4G, 0G0FT4G-VERS.032008, 0G0FT5G, 0G0FT5G-VERS.032008, 0G1BR3G, 190FT15G, 190FT42G, 190FT4G, 190FT6G, 1A0FT1G, 1A0FT2G, 1A0FT3G, 1A0FT4G, 1A0FT6G, 1B0FT4G, 1B0FT6G, 1D0FT1G, 1D0FT2G, 1D0FT3G, 1D0FT4G, 1D0FT6G, 1G0FT4G, 1G0FT4G-VERS.032008, 1G0FT6G...(Otros modelos se puede ver en la tienda web)		



código	375307	referencia	32Z9201 32Z9202
descripción	termostato de seguridad temp. desconexión 365°C 3 polos 20A sonda ø 4mm sonda L 120mm capilar 1300mm aislamiento del capilar 1250mm prensaestopas bulbo inox		
Para modelos:	031FTE04, 031FTE06, 06WBR3E, 06WFT1EV, 06WFT2EV, 06WFT3EV, 06WFT4EV, 06WFT6EV, 06WFT7EV, 070FTE04, 070FTE05, 071FTE04, 071FTE06, 08WFA4E, 08WFAAE, 08WFT1EV, 08WFT2EV, 08WFT3EV, 08WFT4EV, 08WFT6EV, 08WFT7EV, 090FT1E, 090FT2E, 090FT4E, 090FT5E, 090FT7E, 090FTE04, 090FTE05, 091FT1E, 091FT2E, 091FT4E, 091FT5E, 091FT7E, 091FTE04, 091FTE06, 0A0FT1E, 0A0FT2E, 0A0FT4E, 0A0FT5E, 0D0FT1E, 0D0FT2E, 0D0FT4E, 0D0FT5E, 0G0FT1E, 0G0FT2E, 0G0FT4E, 0G0FT5E, 0G0FT7E, 0G1BR3E, 0G1FT2E...(Otros modelos se puede ver en la tienda web)		

serie 55.10/19_





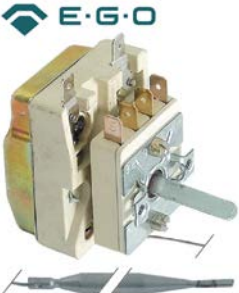

código	375288	referencia	32Z6630
descripción	termostato aislamiento del capilarmm prensaestopas eje ø 6x4,6mm sonda roscada		
Para modelos:	030FE1B, 091FE28B, 091FR1G, 091FR3G, 0A1FR1G, 0A1FR1G-VERS.2004, 0A1FR3G, 0A1FR3GD, 0B1FR1G, 0D1FR1G, 0D1FR1G-VERS.2004, 0D1FR3G, 0D1FR3GD, 0G1FR3G, 191FR2G, 191FR4G, 1A1FR2G, 1A1FR2G-VERS.2004, 1A1FR4G, 1A1FR4GD, 1D1FR2G, 1D1FR2G-VERS.2004, 1D1FR4G, 1D1FR4GD, 1G1FR4G, 30F1B, 30FES2B, 30FS2B, 70F1B, 70FE1B, 70FES2, 70FES2B, 71F2B, 71FE2B, 90F110B, 91F210B, 91F223B		

termostatos de regulación con interruptor auxiliar
serie 51_



código	375346	referencia	32Z9270
descripción	termostato T máx 110°C margen de trabajo 30-110°C 1 polos 1NO 15A sonda ø 6mm sonda L 130mm capilar 900mm aislamiento del capilar 900mm eje ø 6x4,6mm eje L 23mm posición del eje arriba ángulo de rotación 318° interruptor auxiliar 2NO		



código	375289	referencia	32Z2480
descripción	termostato T máx 180°C margen de trabajo 100-180°C 1 polos 1NO 16A sonda ø 11mm sonda L 10mm capilar 850mm aislamiento del capilar 850mm prensaestopas interruptor auxiliar 2NO rosca sonda M14x1		
Para modelos:	030FE, 30FES, 70FE, 70FES, 71FE		
repuestos para	375289		
		código	300200
		referencia	—
			interruptor auxiliar 2 posiciones de conmutación 2NO 16A secuencia de conmutación 0-1 eje ø 6x4,6mm eje L 23mm empalme conector Faston 6,3mm interruptor cerámica
		código	550060
		referencia	—
			estribo de unión largo para termostato UE 1 pzs
accesorios para	375289		
		código	361182
		referencia	3117580
			tuerca rosca 1/4" H 5mm latón niquelado EC 17 UE 1 pzs
		código	532520
		referencia	3150390
			junta tórica silicona espesor 2.62mm int.ø 15.08mm UE 1 pzs







código	390069	referencia	32Z0500
descripción	termostato T máx 265°C margen de trabajo 45-265°C 1 polos 1NO 15A sonda ø 3mm sonda L 219mm capilar 900mm aislamiento del capilarmm eje ø 6x4,6mm eje L 23mm posición del eje arriba ángulo de rotación 270° interruptor auxiliar 2NO		





código	390765	referencia	32Z5970
descripción	termóstato T máx 110°C margen de trabajo 30-110°C 3 polos 3NO 16A sonda ø 6mm sonda L 131mm capilar 1160mm prensaestopas eje ø 6x4,6mm eje L 23mm posición del eje arriba ángulo de rotación 310°		
Para modelos:	ACBM, ACBM218, ANBM, ANBM218, ANBM75, SE14VB, SE21VB, SI14VB, SI21VB, SL14CVB, SL14NVB, SL21CVB, SL21NVB, SL7NVB, TBM, TBM218		



código	375274	referencia	32Z7400
descripción	termóstato T máx 260°C margen de trabajo 100-260°C 3 polos 3NO 16A sonda ø 6mm sonda L 75mm capilar 1150mm aislamiento del capilar 1150mm prensaestopas ángulo de rotación 270°		
Para modelos:	031FTE04, 031FTE06, 06WFT1EV, 06WFT2EV, 06WFT3EV, 06WFT4EV, 06WFT6EV, 06WFT7EV, 070FTE04, 070FTE05, 071FTE04, 071FTE06, 08WFT1EV, 08WFT2EV, 08WFT3EV, 08WFT4EV, 08WFT6EV, 08WFT7EV, 090FT1E, 090FT2E, 090FT4E, 090FT5E, 090FT7E, 090FTE04, 090FTE05, 091FT1E, 091FT2E, 091FT4E, 091FT5E, 091FT7E, 091FTE04, 091FTE06, 0A0FT1E, 0A0FT2E, 0A0FT4E, 0A0FT5E, 0D0FT1E, 0D0FT2E, 0D0FT4E, 0D0FT5E, 0G0FT1E, 0G0FT2E, 0G0FT4E, 0G0FT5E, 0G0FT7E, 0G1FT2E, 0G1FT4E, 0G1FT5E, 0G1FT7E, 190FT15E...(Otros modelos se puede ver en la tienda web)		
repuestos para	375274		
	código	300200	referencia —
	interruptor auxiliar 2 posiciones de conmutación 2NO 16A secuencia de conmutación 0-1 eje ø 6x4,6mm eje L 23mm empalme conector Faston 6,3mm interruptor cerámica		
	código	375813	referencia —
	termóstato T máx 260°C margen de trabajo 100-260°C 3 polos 3NO 16A sonda ø 6mm sonda L 75mm capilar 1150mm aislamiento del capilar 1150mm prensaestopas eje ø 6x4,6mm eje L 23mm posición del eje arriba ángulo de rotación 270°		
	código	550060	referencia —
	estribo de unión largo para termostato UE 1 pzs		



código	375269	referencia	32Z3790
descripción	termóstato T máx 300°C margen de trabajo 100-300°C 3 polos 3NO 16A sonda ø 6mm sonda L 75mm capilar 1150mm aislamiento del capilar 1150mm prensaestopas eje L 23mm ángulo de rotación 270° interruptor auxiliar 4NO		
Para modelos:	030FTE, 030FTEr, 031FTE, 031FTEr, 031FTErL		
repuestos para	375269		
	código	300080	referencia —
	conmutador de levas 2 posiciones de conmutación 4NO 16A secuencia de conmutación 0-1 eje ø 6x4,6mm eje L 23mm empalme atornillado interruptor cerámica temperatura ambiente máx. 150°C		
	código	375453	referencia —
	termóstato T máx 308°C margen de trabajo 100-300°C 3 polos 3NO 16A sonda ø 6mm sonda L 75mm capilar 1150mm aislamiento del capilar 1150mm prensaestopas eje ø 6x4,6mm eje L 23mm ángulo de rotación 270° material de bulbo inox		
	código	550060	referencia —
	estribo de unión largo para termostato UE 1 pzs		



código	375299	referencia	32V0660 32V0661
descripción	termóstato T máx 330°C margen de trabajo 60-330°C 2 polos 2NO 16A sonda ø 4mm sonda L 128mm capilar 1500mm aislamiento del capilar 1450mm prensaestopas eje ø 6x4,6mm eje L 23mm posición del eje arriba ángulo de rotación 270° interruptor auxiliar 2NO		
Para modelos:	191BR1E, 191BR1G, 191BR1GA, 191BR2E, 191BR2EA, 191BR2G, 191BR2GA, 1A1BR1E, 1A1BR1G, 1A1BR1GA, 1A1BR2E, 1A1BR2EA, 1A1BR2G, 1A1BR2GA, 1D1BR1E, 1D1BR1G, 1D1BR1GA, 1D1BR2E, 1D1BR2EA, 1D1BR2G, 1D1BR2GA, 291BR1E, 291BR1G, 291BR1GA, 291BR2E, 291BR2EA, 291BR2G, 291BR2GA, 2A1BR1E, 2A1BR1G, 2A1BR1GA, 2A1BR2E, 2A1BR2EA, 2A1BR2G, 2A1BR2GA, 2D1BR1E, 2D1BR1G, 2D1BR1GA, 2D1BR2E, 2D1BR2EA, 2D1BR2G, 2D1BR2GA		
repuestos para	375299		
	código	300200	referencia —
	interruptor auxiliar 2 posiciones de conmutación 2NO 16A secuencia de conmutación 0-1 eje ø 6x4,6mm eje L 23mm empalme conector Faston 6,3mm interruptor cerámica		
	código	550060	referencia —
	estribo de unión largo para termostato UE 1 pzs		



IMIT / TEMPOMATIC / ARTHERMO

termostatos de regulación



código	390193	referencia	32V1920
descripción	termóstato T máx 56°C margen de trabajo 0-90°C 1 polos 1CO 16A sonda ø 6.5mm sonda L 95mm capilar 1500mm aislamiento del capilar 1500mm prensaestopas eje ømm eje Lmm posición del eje ángulo de rotación 270° material de bulbo cobre		
Para modelos:	LC100, LC100-VERS.2001, LC130, LC130-VERS.2001, LC80		



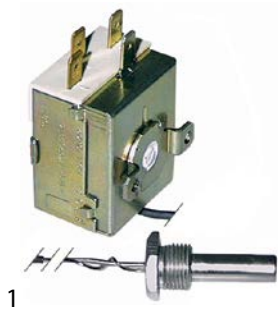

código	390421	referencia	32Z7200
descripción	termóstato T máx 85°C margen de trabajo 0-90°C 1 polos 1CO 16A sonda ø 6.5mm sonda L 95mm capilar 1500mm aislamiento del capilar 1450mm prensaestopas eje ømm eje Lmm posición del eje ángulo de rotación 270° material de bulbo cobre		
Para modelos:	LT10R, LT20F, LT25F		



código	390310	referencia	32V2630	
descripción	termóstato T máx 85°C margen de trabajo ajuste fijo 55°C 1 polos 1CO 16A sonda ø 9.5mm sonda L 37mm capilar 600mm aislamiento del capilar 540mm prensaestopas eje ømm eje Lmm posición del eje ángulo de rotación° sonda roscada rosca sonda 3/8" material de bulbo inox			
Para modelos:	LF50, LF50E, LF50EM, LF50EMPS, LF50E-VERS.2007			
accesorios para	390310			
	código	506024	referencia	—
	tuerca rosca 3/8" H 6mm inox EC 22 UE 1 pzs			
	código	529349	referencia	—
	junta plana FIBER ø ext. 22mm int.ø 16.5mm espesor 2mm para rosca 3/8" UE 1 pzs			



código	390006	referencia	32V1910 32Z8840
descripción	termóstato T máx 86°C margen de trabajo 0-86°C 1 polos 1CO 16A sonda ø 6.5mm sonda L 95mm capilar 1500mm aislamiento del capilar mm prensaestopas eje ø 6x4,6mm eje L 19mm ángulo de rotación 270°		
Para modelos:	C207D-VERS.2006, C207S-VERS.2006, C207VD-VERS.2006, C207VS-VERS.2006, C304AD-VERS.2006, C304AS-VERS.2006, C304AVD-VERS.2006, C304AVS-VERS.2006, C304D-VERS.2006, C304S-VERS.2006, C304VD-VERS.2006, C304VS-VERS.2006, C92D-VERS.2006, C92S-VERS.2006, C92VD-VERS.2006, C92VS-VERS.2006, CS243D-VERS.2006, CS243S-VERS.2006, CS243VD-VERS.2006, CS243VS-VERS.2006, CS370AD-VERS.2006, CS370AS-VERS.2006, CS370AVD-VERS.2006, CS370AVS-VERS.2006, CS370D-VERS.2006, CS370S-VERS.2006, CS370VD-VERS.2006, CS370VS-VERS.2006, CS466AD-VERS.2006, CS466AS-VERS.2006, CS466AVD-VERS.2006, CS466AVS-VERS.2006, CS466D-VERS.2006, CS466S-VERS.2006, CS466VD-VERS.2006, CS466VS-VERS.2006, LC100, LC100-VERS.2001, LC130, LC130-VERS.2001, LC80, LF50		

accesorios para	390006			
	código	110100	referencia	36M2830
	pomo termostato T máx 90°C 0-90°C ø 42mm eje ø 6x4,6mm parte plana -135° negro			
	código	110105	referencia	—
	roseta pomo ø 42mm ø 56mm marca cero			



código	390704	referencia	32Z8840
descripción	termóstato T máx 86°C margen de trabajo 0-86°C 1 polos 1CO 16A sonda ø 6.5mm sonda L 98mm capilar 1020mm aislamiento del capilar 950mm prensaestopas eje ø 6x4,6mm eje L 19mm posición del eje +135° ángulo de rotación 270° material de bulbo cobre 250V		
Para modelos:	C165D, C165S, C165VD, C165VS, C207D, C207S, C207VD, C207VS, C304AD, C304AD-VERS.2006, C304AS, C304AS-VERS.2006, C304AVD, C304AVD-VERS.2006, C304AVS, C304AVS-VERS.2006, C304D, C304D-VERS.2006, C304S, C304S-VERS.2006, C304VD, C304VD-VERS.2006, C304VS, C304VS-VERS.2006, CS243D, CS243D-VERS.2006, CS243S, CS243S-VERS.2006, CS243VD, CS243VD-VERS.2006, CS243VS, CS243VS-VERS.2006, CS370AD, CS370AD-VERS.2006, CS370AS, CS370AS-VERS.2006, CS370AVD, CS370AVD-VERS.2006, CS370AVS, CS370AVS-VERS.2006, CS370D, CS370D-VERS.2006, CS370S, CS370S-VERS.2006, CS370VD, CS370VD-VERS.2006, CS370VS, CS370VS-VERS.2006, CS466AD, CS466AD-VERS.2006...(Otros modelos se puede ver en la tienda web)		



código	390460	referencia	32V7240
descripción	termóstato T máx 90°C margen de trabajo 30-90°C 1 polos 1CO 16A sonda ø 6.5mm sonda L 95mm capilar 2000mm aislamiento del capilar 1950mm prensaestopas eje ømm eje Lmm posición del eje ángulo de rotación 270° material de bulbo cobre		

termostatos de seguridad



código	390023	referencia	32Z8530 32Z8830
descripción	termóstato de seguridad temp. desconexión 90-110°C 1 polos 16A sonda ø 6.5mm sonda L 90mm capilar 1000mm aislamiento del capilar prensaestopas bulbo		
Para modelos:	C165D, C165S, C207D, C207D-VERS.2006, C207S, C207S-VERS.2006, C207VD-VERS.2006, C207VS-VERS.2006, C304AD, C304AD-VERS.2006, C304AS, C304AS-VERS.2006, C304AVD-VERS.2006, C304A-VS-VERS.2006, C304D, C304D-VERS.2006, C304S, C304S-VERS.2006, C304VD-VERS.2006, C304VS-VERS.2006, C92D-VERS.2006, C92S-VERS.2006, C92VD-VERS.2006, C92VS-VERS.2006, CS243D, CS243S, CS243VD, CS243VS, CS370AD, CS370AS, CS370AVD, CS370AVS, CS370D, CS370S, CS370VD, CS370VS, CS466AD, CS466AS, CS466AVD, CS466AVS, CS466D, CS466S, CS466VD, CS466VS, LC100, LC100-VERS.2001, LC130, LC130-VERS.2001, LC80, LF50...(Otros modelos se puede ver en la tienda web)		

PRODIGY / FIRT

termostatos de regulación



código	390723	referencia	32Z0190
descripción	termóstato PRODIGY margen de trabajo -35 a +35°C sonda ø 6mm sonda L 110mm capilar 1500mm tipo TR/711-N		
accesorios para	390723		
		código	110305
		referencia	—
para modelos:	pomo termóstato T máx 35°C margen de trabajo -35 a +35°C ø 45mm eje ø 6x4,6mm parte plana inclinado ángulo de rotación 270° blanco		

RANCO

termostatos de seguridad



código	375832	referencia	3040550
descripción	termóstato de seguridad T máx 70°C margen de trabajo 0-70°C 1 polos 1NO 16A sonda ø 8mm sonda L 60mm capilar 870mm aislamiento del capilar prensaestopas eje ømm eje Lmm posición del eje ángulo de rotación° material de bulbo cobre temp. desconexión 70°C		
Para modelos:	PG22C, PG23C, PG23CW, PG24CW, PG30C, PG31CW, PG42C, PG43CW, PG60C, PG61CW, PG80C, PG80C-VERS.200911, PG81CW, PG81CW-VERS.200911, PGC132, PGC134W, PGC210, PGC212W		

diversos

termostatos de regulación



código	375287	referencia	6300359
descripción	termóstato T máx 190°C margen de trabajo 160-190°C sonda ø 16mm sonda L 93mm rosca sonda 1/2"		
Para modelos:	030FE1, 30F1, 30FES2, 30FS2, 70F1, 70FE1, 70FES2, 71F2, 71FE2, 91F210		

termostatos de regulación con interruptor auxiliar



código	375951	referencia	6300738
descripción	termóstato T máx 187°C 1 polos 1NO sonda ø 6mm sonda L 132mm capilar 900mm aislamiento del capilar 480mm eje ø 4,5x6mm eje L 23mm interruptor auxiliar 42.02900.000 con casquillo de inmersión		
Para modelos:	030FE1B, 091FE28B, 091FR1G, 091FR3G, 0A1FR1G, 0A1FR1G-VERS.2004, 0A1FR3G, 0A1FR3GD, 0B1FR1G, 0D1FR1G, 0D1FR1G-VERS.2004, 0D1FR3G, 0D1FR3GD, 0G1FR3G, 191FR2G, 191FR4G, 1A1FR2G, 1A1FR2G-VERS.2004, 1A1FR4G, 1A1FR4GD, 1D1FR2G, 1D1FR2G-VERS.2004, 1D1FR4G, 1D1FR4GD, 1G1FR4G, 30F1B, 30FES2B, 30FS2B, 70F1B, 70FE1B, 70FES2, 70FES2B, 71F2B, 71FE2B, 90F110B, 91F210B, 91F223B		
repuestos para	375951		
		código	301115
		referencia	3168540
para modelos:	comutador de levas 2 posiciones de conmutación 2NO secuencia de conmutación 0-1 16A eje ø 6x4,6mm eje L 23mm empalme conector Faston 6,3mm		

Continúa en la página siguiente



repuestos para	375951			
	código	375922	referencia	3168460
	termostato T máx 185°C margen de trabajo 101-185°C 1 polos 1NO 16A sonda ø 6mm sonda L 133mm capilar 870mm aislamiento del capilar 520mm prensaestopas M10x1 eje ø 6x4,6mm eje L 23mm posición del eje arriba			

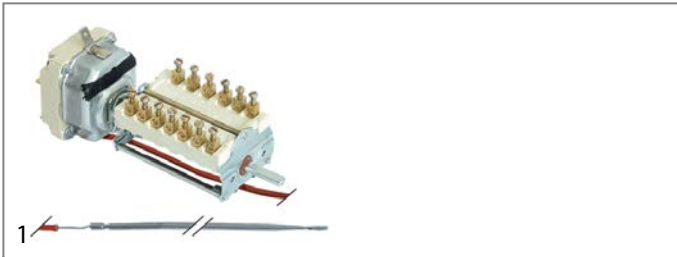

código	375267	referencia	32Z3550 32Z3551
descripción	termostato T máx 290°C margen de trabajo 50-290°C 3 polos 3NO sonda ø 3mm sonda L 219mm capilar 1200mm aislamiento del capilar 1200mm posición del eje abajo ángulo de rotación 270°		
Para modelos:	1G1FA0E, 1G1FA0EV, 1G1PE1E, 1G1PE1EV, 1G1PE2E, 1G1PE2EV, 2G1FA0E, 2G1PE1E, 2G1PE1EV, 2G1PE2E, 2G1PE2EV, 31GE, 31TCE, 32TCE		

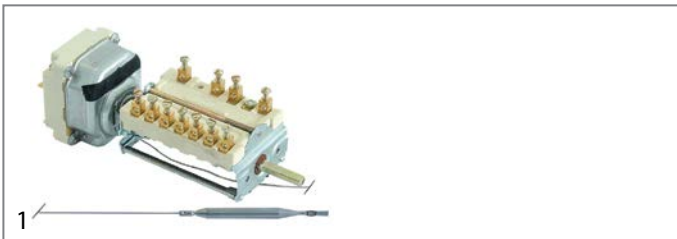

código	375265	referencia	32W0030
descripción	termostato T máx 300°C margen de trabajo 50-300°C 3 polos 3NO 16A sonda ø 6mm sonda L 79mm capilar 1740mm aislamiento del capilar 800mm eje ø 6x4,6mm ángulo de rotación 270°		

repuestos para	375265			
	código	375038	referencia	32Z2560
	termostato T máx 300°C margen de trabajo 50-300°C 3 polos 3NO 16A sonda ø 6mm sonda L 79mm capilar 1740mm aislamiento del capilar 800mm prensaestopas eje ø 6x4,6mm eje L 23mm posición del eje arriba ángulo de rotación 270°			

	código	550059	referencia	—
	estribo de unión corto para interruptor UE 1 pzs			

termostatos de seguridad



código	390194	referencia	32V7260
descripción	termostato de seguridad temp. desconexión 90-110°C 1 polos 16A sonda ø 6.5mm sonda L 87mm capilar 1500mm aislamiento del capilar 1497mm empalme conector Faston 6,3mm ajustable		

termostatos para frío

universal sin alojamiento



código	390534	referencia	32Z1090 32Z2590 32Z6310 32Z7110
---------------	--------	-------------------	--

descripción	termostato margen de trabajo -35 a +35°C bulbo ø6x110mm capilar 1800mm PRODIGY		
Para modelos:	120, 120B, 120NN, 120PV, 135, 135-4, 135B, 135BA, 135BN, 135BNX, 135BX, 135BXE, 135BXR, 135CPX, 135NN, 135NNX, 135PVX, 135X, 135X-3, 135X-4, 135XR, 40CP, 40CPX, 55, 55B, 55PV, 65, 65B, 65BA, 65BX, 65BX-2, 65BXE, 65BXR, 65NB, 65NBX, 65NN, 65NNX, 65PVX, 65X, 65X-2, 65XR, 6BMA11A, 6BMA11B, 6BMA11M, 6BMA11M, 6BMA2A, 6BMA2B, 6BMA2M, 6BMA3A, 6BMA3B, 6BMA3M...(Otros modelos se puede ver en la tienda web)		

accesorios para	390534			
	código	110305	referencia	—
	pomo termostato T máx 35°C margen de trabajo -35 a +35°C ø 45mm eje ø 6x4,6mm parte plana inclinado ángulo de rotación 270° blanco			

RANCO

serie K22

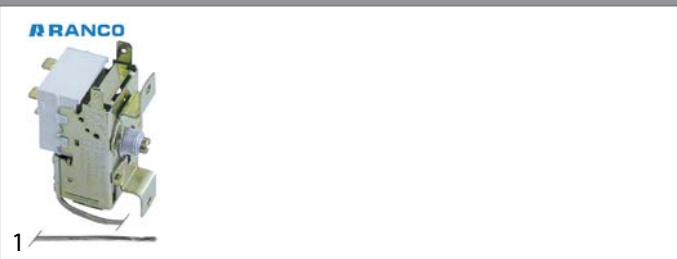

código	390202	referencia	32Z7450
descripción	termostato RANCO tipo K22L2025 sonda ømm sonda Lmm capilar 1500mm margen de trabajo +1°C a +11°C		
Para modelos:	PGA20, PGA30, PGA40, PGA60, PGA80, PGW20, PGW30, PGW40, PGW60, PGW80		



código	390207	referencia	32Z3890
descripción	termostato RANCO tipo K22L2030 sonda ø 2mm sonda Lmm capilar 2000mm margen de trabajo -13 a -4°C		
Para modelos:	PGA20, PGA30, PGA40, PGA60, PGA80, PGW20, PGW30, PGW40, PGW60, PGW80		

código	390209	referencia	32V2280 32V4360
descripción	termóstato RANCO tipo K22L1020 sonda ø 9mm sonda L 40mm capilar 2000mm margen de trabajo -20,5 a -1,5°C		
Para modelos:	PG22C, PG23C, PG23CW, PG24CW, PG30C, PG31CW		



código	390254	referencia	32V4270
descripción	termóstato RANCO tipo K50P1135 sonda ømm sonda Lmm capilar 2500mm T fría 1.5°C		



código	390737	referencia	32V4400
descripción	termóstato RANCO tipo K22-L1074 sonda ø 9mm sonda L 42mm capilar 1450mm margen de trabajo -19 a -1°C		
Para modelos:	PG42C, PG43CW, PG60C, PG61CW, PG80C, PG80C-VERS.200911, PG81CW, PG81CW-VERS.200911, PGC132, PGC132-VERS.200911, PGC134W, PGC134W-VERS.200911, PGC210, PGC210-VERS.200911, PGC212W, PGC212W-VERS.200911		



código	390581	referencia	3111590
descripción	termóstato RANCO tipo K50-S3595 sonda ø 2mm sonda Lmm capilar 2000mm		
Para modelos:	PG23C, PG24CW, PG30C, PG31CW		

serie K50



código	390208	referencia	3034730
descripción	termóstato RANCO tipo K50L3006 sonda ømm sonda Lmm capilar 2000mm margen de trabajo +1,5 F7820 +4°C		
Para modelos:	PG22C, PG23C, PG23CW, PG24CW, PG30C, PG31CW, PG42C, PG43CW, PG60C, PG61CW, PG80C, PG80C-VERS.200911, PG81CW, PG81CW-VERS.200911, PGC132, PGC132-VERS.200911, PGC134W, PGC134W-VERS.200911, PGC210, PGC210-VERS.200911, PGC212W, PGC212W-VERS.200911		

serie K52

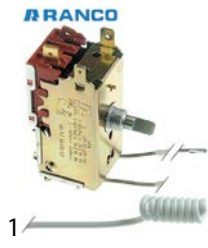

código	390214	referencia	32Z0920
descripción	termóstato RANCO tipo K52L4512 sonda ø 11mm sonda L 30mm capilar 2100mm margen de trabajo -6,4 a +3,2°C		
Para modelos:	40, 40EV, 40EVP, 40PL, 40PV, 40X, 40XPV		



código	390278	referencia	32Z6360
descripción	termóstato RANCO tipo K50L3207 sonda ømm sonda Lmm capilar 1500mm margen de trabajo -10 a -2°C		
Para modelos:	BRPR, BRPR218, BRPR21C, BRPRV, BRVR, BRVR218, BRVR21C, BRVRV, TPR, TPR218, TPR21C, TPRV, TVR, TVR218, TVR21C, TVRV		

serie K55



código	390252	referencia	32Z7580
descripción	termóstato RANCO tipo K55L5070 capilar 2500mm margen de trabajo -22 a -7°C		
Para modelos:	40B, S125B, S125B-4, S125BX, S125BX-4, S60B, S60B-2, S60BX, S60BX-2		

serie K60



código	390598	referencia	32Z4730
descripción	termóstato RANCO tipo K60-L2045 sonda ø 2mm sonda Lmm capilar 2000mm		

accesorios

clips para bulbo

pinzas

para termostato



código	691171	referencia	35T3540
descripción	clip para bulbo para sonda ø 9mm UE 1 pzs L 30mm An 20mm		
Para modelos:	030FE, 030FE1, 030FE1B, 031FT04, 031FT06, 031FTE04, 031FTE06, 06WBR3E, 06WFT1EV, 06WFT2EV, 06WFT3EV, 06WFT4EV, 06WFT6EV, 06WFT7EV, 070FTE04, 070FTE05, 071FTE04, 071FTE06, 090FT1G, 090FT2G, 090FT4G, 090FT5G, 090FT7G, 090FTE04, 090FTE05, 091FE28, 091FE28B, 091FTE04, 091FTE06, 0A0FT1E, 0A0FT1G, 0A0FT2E, 0A0FT2G, 0A0FT4E, 0A0FT4G, 0A0FT5E, 0A0FT5G, 0B0FT1G, 0B0FT2G, 0B0FT4G, 0B0FT5G, 0D0FT1E, 0D0FT1G, 0D0FT2E, 0D0FT2G, 0D0FT4E, 0D0FT4G, 0D0FT5E, 0D0FT5G, 0G0FT1E...(Otros modelos se puede ver en la tienda web)		



código	691170	referencia	35S0540
descripción	clip para bulbo para sonda ø 9mm UE 1 pzs L 38mm An 20mm		
Para modelos:	030FE, 030FE1, 030FE1B, 091FE28, 091FE28B, 0G1BR3E, 1G1BR3E, 30FES, 70FE, 70FES, 71FE		

otros



código	691175	referencia	35S5040
descripción	clip para bulbo para sonda ø 4mm para tubo ø 9mm		
Para modelos:	030FE1, 030FE1B, 091FE28, 091FE28B, 30FES2, 30FES2B, 70FES2, 70FES2B		

accesorios para prensaestopas

conducciones de paso



código	560623	referencia	3003400
descripción	conducción para prensaestopas M M16 H M10x1 EC 19 L 18mm		
Para modelos:	FM1011E2-VERS.2006, FM1011E3, FM1011E3-VERS.2006, FM1011G2-VERS.2006, FM1011G3, FM1011G3-VERS.2006, FM1221E2-VERS.2006, FM1221E3, FM1221E3-VERS.2006, FM1221G2-VERS.2006, FM1221G3, FM1221G3-VERS.2006, FM2011E2-VERS.2006, FM2011E3-VERS.2006, FM2011G2-VERS.2006, FM2011G3-VERS.2006, FM2021E2-VERS.2006, FM2021E3, FM2021E3-VERS.2006, FM2021G2-VERS.2006, FM2021G3, FM2021G3-VERS.2006, FM423E2, FM611E2-VERS.2006, FM611E3, FM611E3-VERS.2006, FM611G2-VERS.2006, FM611G3, FM611G3-VERS.2006, FM721E2-VERS.2006, FM721E3, FM721E3-VERS.2006, FM721G2-VERS.2006, FM721G3, FM721G3-VERS.2006, FX101E2, FX101E2C, FX101E2C-VERS.032014, FX101E2R, FX101E2R-VERS.032014, FX101E2-VERS.032014, FX101E3, FX101E3C, FX101E3C-VERS.022014, FX101E3R, FX101E3R-VERS.022014, FX101E3-VERS.022014, FX101G2, FX101G2C, FX101G2C-VERS.032014...(Otros modelos se puede ver en la tienda web)		

otros



código	691191	referencia	36D6970
descripción	pieza de empalme para termostato		
Para modelos:	030FE1, 30F1, 30FES2, 30FS2		



código	691154	referencia	37Q3270
descripción	tapa botón de limitación de la temperatura		
Para modelos:	04WCP1EM, 04WFR3ED, 06WFR3GD, 08WFA4E, 08WFAAE, 08WFR4ED, 08WFT1EV, 08WFT2EV, 08WFT3EV, 08WFT4EV, 08WFT6EV, 08WFT7EV, 091CP1E, 091FR1E, 091FR1EA, 091FR1ED, 091FR1G, 091FR1GD, 091FR3E, 091FR3ED, 091FR3G, 091FR3GD, 091FT1E, 091FT2E, 091FT4E, 091FT5E, 091FT7E, 0A1CP1E, 0A1FR1E, 0A1FR1ED, 0A1FR1G, 0A1FR1GD, 0A1FR1GD-VERS.2004, 0A1FR1G-VERS.2004, 0A1FR3G, 0A1FR3GD, 0B1FR1G, 0B1FR1GD, 0D1CP1E, 0D1FR1E, 0D1FR1ED, 0D1FR1G, 0D1FR1GD, 0D1FR1GD-VERS.2004, 0D1FR1G-VERS.2004, 0D1FR3G, 0D1FR3GD, 0G1BR3E, 0G1CP1E, 0G1CP1EC...(Otros modelos se puede ver en la tienda web)		



interruptores y pulsadores

interruptores/pulsadores basculantes

25,5x25mm



1

código	345280 ¹	referencia	32W6010
descripción	interruptor basculante medida de montaje 25,5x25mm verde 2CO 250V 16A iluminado empalme conector Faston 6,3mm temperatura ambiente máx. 85°C protección IP40		

¹iluminado



1

código	345278 ¹	referencia	32W0990 32W3970
descripción	interruptor basculante medida de montaje 25,5x25mm verde 2NO 250V 16A iluminado 0-I empalme conector Faston 6,3mm protección IP40		
Para modelos:	3G6SA, 3G6SA2, 3G6SA4, 40-OPR01, 40B-OPR01, 40BX-OPR01, 40CP-OPR01, 40CPX-OPR01, 40EV-OPR01, 40PV-OPR01, 40X-OPR01, 4G6SB, 4G6SB2, 4G6SB4, 4G6SB6, 6BR15V, 6BR15VC, 6BR19V, 6BR19VC, 6ERA-OPR01, 6ERA2-OPR01, 6ERA2A-OPR01, 6ERA2M-OPR01, 6EAA-OPR01, 6ERAB-OPR01, 6ERABA-OPR01, 6ERABM-OPR01, 6ERAM-OPR01, 6ERB-OPR01, 6ERB2-OPR01, 6ERB2A-OPR01, 6ERB2M-OPR01, 6ERB4-OPR01, 6ERB4A-OPR01, 6ERB4M-OPR01, 6ERBA-OPR01, 6ERBB-OPR01, 6ERBBA-OPR01, 6ERBBM-OPR01, 6ERBM-OPR01, 6ERC-OPR01, 6ERC2-OPR01, 6ERC2A-OPR01, 6ERC2M-OPR01, 6ERC4-OPR01, 6ERC4A-OPR01, 6ERC4M-OPR01, 6ERCA-OPR01, 6ERCB-OPR01, 6ERCBM-OPR01... (Otros modelos se puede ver en la tienda web)		

¹iluminado

30x22mm

con inscripción



1

código	300125	referencia	32W0860 32W2331 32W2990
descripción	interruptor basculante medida de montaje 30x22mm verde 2NO 230V 16A 0-I empalme conector Faston 6,3mm temperatura ambiente máx. 125/55°C protección IP65 con tapa		
Para modelos:	120, 120B, 120NN, 120PV, 135, 135-4, 135A, 135B, 135BA, 135BN, 135BNX, 135BX, 135BXE, 135BXR, 135CPX, 135NN, 135NNX, 135PVX, 135X, 135X-3, 135X-4, 135XE, 135XR, 40, 40B, 40CP, 40CPX, 40EV, 40EVP, 40PL, 40PV, 40X, 40XPV, 55, 55B, 55PV, 65, 65A, 65B, 65BA, 65BX, 65BX-2, 65BXE, 65BXR, 65NB, 65NBX, 65NN, 65NNX, 65PVX, 65X... (Otros modelos se puede ver en la tienda web)		

accesorios para 300125



código	301036	referencia	—
cubierta protectora dimensión interior 30x22mm para interruptor basculante medida de montaje mm			



1

código	301164	referencia	32W0631
descripción	interruptor basculante medida de montaje 30x22mm verde 2NO 250V 16A iluminado empalme conector Faston 6,3mm temperatura ambiente máx. 85°C protección IP65 con tapa		
Para modelos:	1G1FA0EV, 1G1FA0GV, 1G1PE1EV, 1G1PE2EV, 2091SCP, 2G1FA0GV, 2G1PE1EV, 2G1PE2EV, 31GE, 31TC, 31TCE, 32TC, 32TCE, FX101E1, FX101E1R, FX101E2, FX101E2C, FX101E2R, FX101E3, FX101E3C, FX101E3C-VERS.022014, FX101E3R, FX101G1, FX101G1R, FX101G2, FX101G2C, FX101G2R, FX101G3, FX101G3C, FX101G3C-VERS.022014, FX101G3R, FX10E2CR, FX10E3CR, FX10E3CR-VERS.022014, FX10G2CR, FX10G3CR, FX10G3CR-VERS.022014, FX122E1, FX122E2, FX122E2C, FX122E3, FX122E3C, FX122G1, FX122G2, FX122G2C, FX122G3, FX122G3C, FX12E3CT, FX12E3CT-VERS.022014, FX12G3CT... (Otros modelos se puede ver en la tienda web)		

accesorios para 301164



código	301036	referencia	—
cubierta protectora dimensión interior 30x22mm para interruptor basculante medida de montaje mm			



1

código	345275	referencia	32W3190
descripción	interruptor basculante medida de montaje 30x22mm blanco 1CO/ lámpara 230V 16A 1-2 empalme conector Faston 6,3mm temperatura ambiente máx. 125/55°C protección IP65 con tapa		
Para modelos:	120, 120NN, 120PV, 135, 135-4, 135BN, 135BNX, 135CPX, 135NN, 135NNX, 135PVX, 135X, 135X-3, 135X-4, 135XR, 55, 55PV, 65, 65NB, 65NBX, 65NN, 65NNX, 65PVX, 65X, 65X-2, 65XR, 6BMA11A, 6BMA11B, 6BMA11M, 6BMA11Z, 6BMA2A, 6BMA2B, 6BMA2M, 6BMA2Z, 6BMA3A, 6BMA3B, 6BMA3M, 6BMA3Z, 6BMAA, 6BMAB, 6BMAM, 6BMAZ, 6BMB11A, 6BMB11B, 6BMB11M, 6BMB11Z, 6BMB2A, 6BMB2B, 6BMB2M, 6BMB2Z... (Otros modelos se puede ver en la tienda web)		

interruptores pulsantes y pulsadores

19x13mm



1

código	347431	referencia	3126050
descripción	pulsador medida de montaje 19x13mm rojo 1NO 250V 16A empalme conector Faston 6,3mm temperatura ambiente máx. 105/55°C protección IP40		
Para modelos:	090FAA, 091FR11, 091FR11-VERS.032012, 091FR7G, 091FR7G-VERS.052012, 10CP1GA, 12CP1GA, 18CP2GA, 190FAA, 191FR21, 191FR21-VERS.032012		



1

código	301713	referencia	6300674
descripción	interruptor pulsante medida de montaje 19x13mm azul 1NO 250V 16A empalme conector Faston 6,3mm temperatura ambiente máx. 85°C protección IP65 con tapa		
Para modelos:	191BR1E, 191BR1G, 191BR1GA, 191BR2E, 191BR2EA, 191BR2G, 191BR2GA, 291BR1E, 291BR1G, 291BR1GA, 291BR2E, 291BR2EA, 291BR2G, 291BR2GA		



2

código	301054	referencia	3062550 6300676
descripción	pulsador medida de montaje 19x13mm rojo 1NO 250V 16A empalme conector Faston 6,3mm temperatura ambiente máx. 105/55°C protección IP65 con tapa		
Para modelos:	090BM1G, 090FAVA, 090FT1G, 090FT2G, 090FT4G, 090FT5G, 090FT7G, 090GRG, 091CP1G, 190BM2G, 190FAB, 190FT15G, 190FT1G, 190FT2G, 190FT3G, 190FT42G, 190FT4G, 190FT6G, 190FT72G, 190FT7G, 190GRG, 190TP0, 191CP1G, 191CP1GA, 191CP2G, 191FAAG, 191FABG, 191FADG, 191FAG, 191PD1G, 191PD2G, 191PI1G, 191PI1GA, 191PI2G, 191PI2GA, 191TPG, 291FAG, 291FAGF, 291PD3G, 291PI3G, 291TPCG, 391FAG, G1FAGS, G1FAGST		

28,5x28,5mm



1

código	346914	referencia	32V2040
descripción	interruptor pulsante medida de montaje 28,5x28,5mm débil 2CO 250V 16A empalme conector Faston 6,3mm temperatura ambiente máx. 150°C protección IP40		
Para modelos:	LF50, LF50E, LF50EM, LF50E-VERS.2007		



1

código	346915	referencia	32V2030
descripción	interruptor pulsante medida de montaje 28,5x28,5mm gris 1CO 250V 16A empalme conector Faston 6,3mm temperatura ambiente máx. 125/55°C protección IP40		
Para modelos:	LF50, LF50E, LF50EM, LF50E-VERS.2007		



1

código	346916	referencia	32V2050
descripción	pulsador medida de montaje 28,5x28,5mm gris 1NO 250V 16A empalme conector Faston 6,3mm temperatura ambiente máx. 125/55°C protección IP40		
Para modelos:	LF50, LF50E, LF50EM, LF50E-VERS.2007		



1

código	345589	referencia	32V2030 32V2070
descripción	interruptor pulsante medida de montaje 28,5x28,5mm amarillo 2CO 250V 16A empalme conector Faston 6,3mm temperatura ambiente máx. 85/125°C protección IP40		



1

código	345587	referencia	32V2050
descripción	pulsador medida de montaje 28,5x28,5mm amarillo 1NO 250V 16A empalme conector Faston 6,3mm temperatura ambiente máx. 125°C protección IP40		

ø22mm



1

código	699002	referencia	32W2030
descripción	pulsador montaje ø 22mm negro/blanco 1NO/1NC/lámpara 230V 6A 0-1 empalme atornillado temperatura ambiente máx. 70°C protección IP40		
Para modelos:	TG12, TG12X, TG12XE		

ø25mm



1

código	301322	referencia	3203760
descripción	interruptor pulsante montaje ø 25mm plata 1NO/1NC 250V 5A acero inoxidable empalme conector Faston 2,8mm		
Para modelos:	B151H, B151M, FX201E2, FX201E2P, FX201E2P-VERS.032014, FX201E2-VERS.032014, FX201E3, FX201E3P, FX201E3P-VERS.022014, FX201E3-VERS.022014, FX201G2, FX201G2P, FX201G2P-VERS.032014, FX201G2-VERS.032014, FX201G3P, FX201G3-VERS.022014, FX202E2, FX202E2-VERS.032014, FX202E3, FX202E3-230V-3-50Hz-60Hz, FX202E3-230V-3-50Hz-60Hz-VERS.022014, FX202E3-VERS.022014, FX202G2, FX202G2-VERS.032014, FX202G3, FX202G3-VERS.022014		

sujeción 2 orificios





1

código	346906	referencia	32W0280
descripción	conmutadores combinados 2CO/2CO/2NO		

 <p>1</p>			
código	346905	referencia	32W0830
descripción	conmutadores combinados 2CO/2CO/2NO 250V 16A empalme conector Faston 6,3mm temperatura ambiente máx. 85°C protección IP40		

<p>otros</p>			
 <p>1</p>			
código	346910	referencia	32W0410
descripción	pulsador verde 1NO/1NC/lámpara 600V 10A empalme atornillado temperatura ambiente máx. 85°C protección IP40		

 <p>1</p>			
código	346911	referencia	32W1430
descripción	pulsador verde 2NO 300V 3A empalme atornillado temperatura ambiente máx. 125/55°C protección IP40		

 <p>1</p>			
código	348228	referencia	32W4140
descripción	interruptor pulsante montaje ø 12mm negro 2NO/1NC 250V 16A empalme conector Faston 6,3mm		
Para modelos:	KD100, KD100A, KD100PSD, KD85, KD85A, KD85PS, KD85PSA, KN1100, KN1100SD, KN11PSDD, KN35, KN37, KN37PS, KN800, KN800PSD		

<p>accesorios</p>			
<p>teclas</p>			
 <p>1</p>			
código	346912	referencia	32W1420
descripción	tecla negro		

microinterruptores

accionado por palanca

 <p>1</p>			
código	345257	referencia	32W4240
descripción	microinterruptor con manilla 250V 16A 1CO empalme conector Faston 6,3mm L 29mm L1 33mm temperatura ambiente máx. 120°C distancia de sujeción 22mm fuerza de accionamiento: 130g longitud de palanca 31.5mm		

 <p>1</p>			
código	345255	referencia	32W1320
descripción	microinterruptor con manilla 250V 16A 1CO empalme conector Faston 6,3mm L 35mm L1 28mm temperatura ambiente máx. 125°C distancia de sujeción 22mm fuerza de accionamiento: 136g longitud de palanca 27mm		
Para modelos:	120, 120B, 120NN, 120PV, 135, 135-4, 135A, 135B, 135BA, 135BN, 135BNX, 135BX, 135BXE, 135BXR, 135CPX, 135NN, 135NNX, 135PVX, 135X, 135X-3, 135X-4, 135XE, 135XR, 40, 40CP, 40CPX, 40PV, 40X, 40XPV, 55, 55B, 55PV, 65, 65A, 65B, 65BA, 65BX, 65BX-2, 65BXE, 65BXR, 65NB, 65NBX, 65NN, 65NNX, 65PVX, 65X, 65X-2, 65XE, 65XR, S125... (Otros modelos se puede ver en la tienda web)		

 <p>1</p>			
código	345254	referencia	32W1320
descripción	microinterruptor con manilla 250V 16A 1CO empalme conector Faston 6,3mm temperatura ambiente máx. 120°C distancia de sujeción 22mm fuerza de accionamiento: 60g longitud de palanca 58mm		

 <p>1</p>			
código	345459	referencia	32W1180
descripción	microinterruptor con manilla 250V 15A 1NC empalme conector Faston 6,3mm temperatura ambiente máx. 85°C distancia de sujeción 15-25mm ROLD longitud de palanca 66mm serie RM		

 <p>1</p>			
código	346909	referencia	32W0010
descripción	microinterruptor con manilla 250V 16A 1CO empalme conector Faston 6,3mm temperatura ambiente máx. 125°C distancia de sujeción 13mm longitud de palanca 50mm		



			
código	346907	referencia	32W0020
descripción	microinterruptor con manilla 250V 16A 1CO empalme conector Faston temperatura ambiente máx. 85°C		



			
código	346904	referencia	32W3700
descripción	microinterruptor con manilla 250V 16A 1NO empalme conector Faston temperatura ambiente máx. conector Faston 6,3mm°C		
Para modelos:	0M0FR1E, 1M0FR2E		

accionados por pistón

M10

			
código	347216	referencia	32W1660 32W3340
descripción	microinterruptor con varilla rosca M10x0,75 rosca L 14mm 250V 10A 1CO empalme conector Faston 6,3mm carrera 7.5mm distancia de sujeción 22mm L 28mm temperatura ambiente máx. 125°C tipo NR6K5 fuerza de accionamiento: 260g		
Para modelos:	030FE, 030FE1, 030FE1B, 04WFR3ED, 08WFR4ED, 091FE28, 091FE28B, 091FR3E, 091FR3ED, 0A1FR3E, 0A1FR3ED, 0D1FR3E, 0D1FR3ED, 0G0FR3E, 0G0FR3ED, 10CP1EA, 10CP1GA, 10CP1IA, 12CP1EA, 12CP1GA, 12CP1IA, 18CP2EA, 18CP2GA, 18CP2IA, 191BR1E, 191BR1G, 191BR2E, 191BR2G, 191FR4E, 191FR4ED, 1A1FR4E, 1A1FR4ED, 1D1FR4E, 1D1FR4ED, 1G0FR4E, 291BR1E, 291BR1G, 291BR2E, 291BR2G, 30FES, 30FES2, 30FES2B, 6043840, 6043970, 70FE, 70FE1, 70FE1B, 70FES, 70FES2, 70FES2B...(Otros modelos se puede ver en la tienda web)		

M12

			
código	345350	referencia	32W3020
descripción	microinterruptor con varilla distancia de sujeción 22mm rosca M12x0,75 rosca L 16mm 250V 16A 1CO empalme conector Faston 6,3mm carrera 4mm temperatura ambiente máx. 125°C tipo EF83161.3 fuerza de accionamiento: 66g		
Para modelos:	FC101, FC101E, FC241, FC241E, FC241G, FC61, FC61E, FCV101, FCV101DM, FCV101DS, FCV101E, FCV101EDM, FCV101EDS, FCV141, FCV141DM, FCV141DS, FCV141E, FCV141EDM, FCV141EDS, FCV241, FCV241DM, FCV241DS, FCV241E, FCV241EDM, FCV241EDS, FCV241G, FCV241GDM, FCV241GDS, FCV401DM, FCV401EDM, FCV61, FCV61DM, FCV61DS, FCV61E, FCV61EDM, FCV61EDS		
accesorios para	345350		
	código	345351	referencia —
tuerca rosca M12x0,75 H 1.6mm EC 14 latón cromado UE 1 pzs			

			
código	345360	referencia	32W1410
descripción	microinterruptor con varilla distancia de sujeción 25.4mm rosca M12x1 rosca L 15mm 250V 10A 1CO empalme atornillado carrera 5mm temperatura ambiente máx. 125°C tipo Highly D5000 fuerza de accionamiento: 200g		
Para modelos:	65NN, SP65NN		

			
código	345679	referencia	32W0960
descripción	microinterruptor con varilla distancia de sujeción 25mm rosca M12x1 rosca L 9mm 250V 5A 1CO empalme conector Faston 6,3mm carrera 5mm temperatura ambiente máx. 125°C tipo MF12 fuerza de accionamiento: 680g		
Para modelos:	31RE, 71AR		

con tecla

interruptores de enganche rápido

			
código	347027	referencia	32W3770
descripción	microinterruptor con tecla 250V 1A 1CO empalme conector Faston 2,8mm L 26x12mm temperatura ambiente máx. 85°C tipo XKA-304B1AAJ11 fuerza de accionamiento: 50g		
Para modelos:	CX120, CX120B, CX120NN, CX130, CX130B, CX130NN, CX140, CX140B, CX140BN, CX140BR, CX140CP, CX140NN, CX140PV, CX140R, CX150, CX150B, CX150BN, CX150BR, CX150CP, CX150NN, CX150PV, CX150R, CX55, CX55B, CX60, CX60B, CX65, CX652, CX65B, CX65BR, CX65NB, CX65NCP, CX65NN, CX65PV, CX65R, CX70, CX702, CX70B, CX70BR, CX70NB, CX70NN, CX70PV, CX70R, FG2B, FSD1B, FSD1N, FSD2B, FSD2N, FSD2N2, FSDR2B...(Otros modelos se puede ver en la tienda web)		

			
código	348008	referencia	3096020
descripción	microinterruptor con tecla 250V 2.5A 1NO/1NC empalme conector Faston 2,8mm/6,3mm L 27mm L1 22mm temperatura ambiente máx. 104°C fuerza de accionamiento: 180g		

accionados por rodillo

rollo 0°



código	345639	referencia	32W1040
descripción	microinterruptor con rueda de presión 230V 16A 1CO empalme conexión de soldadura/con tornillos L1 49mm temperatura ambiente máx. 125°C rosca L 14mm rosca M10 distancia de sujeción 25mm fuerza de accionamiento: 300g tipo MS15-1		

rollo 90°



código	347096	referencia	32W4130
descripción	microinterruptor con rueda de presión 250V 20A 1CO empalme atornillado L1 49mm temperatura ambiente máx. 125°C rosca L 14.5mm rosca M12x1 distancia de sujeción 25mm fuerza de accionamiento: 370g tipo Z15G1318		
Para modelos:	KD100, KD100A, KD100PSD, KD130, KD130A, KD130E, KD130EAT, KN1100, KN1100SD, KN11PSDD, KN800, KN800PSD		

forma especial



código	346183	referencia	33Q5620 6300496
descripción	microinterruptor empalme conector Faston		
Para modelos:	FC101, FC101E, FC241, FC241E, FC241G, FC61, FC61E, FCV101, FCV101DM, FCV101DS, FCV101E, FCV101EDM, FCV101EDS, FCV141, FCV141DM, FCV141DS, FCV141E, FCV141EDM, FCV141EDS, FCV241, FCV241DM, FCV241DS, FCV241E, FCV241EDM, FCV241EDS, FCV241G, FCV241GDM, FCV241GDS, FCV401DM, FCV401EDM, FCV61, FCV61DM, FCV61DS, FCV61E, FCV61EDM, FCV61EDS		

accesorios



código	691138	referencia	35Q2360
descripción	caja para microinterruptor		
Para modelos:	FC101, FC101E, FC241, FC241E, FC241G, FC61, FC61E, FCV101, FCV101-CSA, FCV101DM, FCV101DM-CSA, FCV101DS, FCV101DS-CSA, FCV101E, FCV101EDM, FCV101EDM-UL, FCV101EDS, FCV101EDS-UL, FCV101E-UL, FCV141, FCV141-CSA, FCV141DM, FCV141DM-CSA, FCV141DS, FCV141DS-CSA, FCV141E, FCV141EDM, FCV141EDS, FCV241, FCV241DM, FCV241DS, FCV241E, FCV241EDM, FCV241EDM-UL, FCV241EDS, FCV241EDS-UL, FCV241E-UL, FCV241G, FCV241GDM, FCV241GDM-CSA, FCV241GDS, FCV241GDS-CSA, FCV401DM, FCV401DM-CSA, FCV401EDM, FCV401EDM-UL, FCV61, FCV61-CSA, FCV61DM, FCV61DM-CSA...(Otros modelos se puede ver en la tienda web)		



código	691140	referencia	33Q5610
descripción	casquillo para microinterruptor rosca M16x1,5		
Para modelos:	FC101, FC101E, FC241, FC241E, FC241G, FC61, FC61E, FCV101, FCV101-CSA, FCV101DM, FCV101DM-CSA, FCV101DS, FCV101DS-CSA, FCV101E, FCV101EDM, FCV101EDM-UL, FCV101EDS, FCV101EDS-UL, FCV101E-UL, FCV141, FCV141-CSA, FCV141DM, FCV141DM-CSA, FCV141DS, FCV141DS-CSA, FCV141E, FCV141EDM, FCV141EDS, FCV241, FCV241DM, FCV241DS, FCV241E, FCV241EDM, FCV241EDM-UL, FCV241EDS, FCV241EDS-UL, FCV241E-UL, FCV241G, FCV241G-CSA, FCV241GDM, FCV241GDM-CSA, FCV241GDS, FCV241GDS-CSA, FCV401DM, FCV401DM-CSA, FCV401EDM, FCV401EDM-UL, FCV61, FCV61-CSA, FCV61DM...(Otros modelos se puede ver en la tienda web)		



código	691142	referencia	36G6040 36G6041
descripción	pasador para microinterruptor		
Para modelos:	FC101, FC101E, FC241, FC241E, FC241G, FC61, FC61E, FCV101, FCV101-CSA, FCV101DM, FCV101DM-CSA, FCV101DS, FCV101DS-CSA, FCV101E, FCV101EDM, FCV101EDM-UL, FCV101EDS, FCV101EDS-UL, FCV101E-UL, FCV141, FCV141-CSA, FCV141DM, FCV141DM-CSA, FCV141DS, FCV141DS-CSA, FCV141E, FCV141EDM, FCV141EDS, FCV241, FCV241DM, FCV241DS, FCV241E, FCV241EDM, FCV241EDM-UL, FCV241EDS, FCV241EDS-UL, FCV241E-UL, FCV241G, FCV241G-CSA, FCV241GDM, FCV241GDM-CSA, FCV241GDS, FCV241GDS-CSA, FCV401DM, FCV401DM-CSA, FCV401EDM, FCV401EDM-UL, FCV61, FCV61-CSA, FCV61DM...(Otros modelos se puede ver en la tienda web)		





código	691143	referencia	36D8360
descripción	perno para microinterruptor		
Para modelos:	FC101, FC101E, FC241, FC61, FC61E, FCV101, FCV101-CSA, FCV101DM, FCV101DM-CSA, FCV101DS, FCV101DS-CSA, FCV101E, FCV101EDM, FCV101EDM-UL, FCV101EDS, FCV101EDS-UL, FCV101E-UL, FCV141, FCV141-CSA, FCV141DM, FCV141DM-CSA, FCV141DS, FCV141DS-CSA, FCV141E, FCV141EDM, FCV141EDS, FCV241, FCV241DM, FCV241DS, FCV401DM, FCV401DM-CSA, FCV401EDM, FCV401EDM-UL, FCV61, FCV61-CSA, FCV61DM, FCV61DM-CSA, FCV61DS, FCV61DS-CSA, FCV61E, FCV61EDM, FCV61EDM-UL, FCV61EDS, FCV61EDS-UL, FCV61E-UL, FCV72EDM-UL, FCV72EDS-UL, FCV72E-UL		



código	691139	referencia	33Q4120 33Q5610
descripción	pieza de empalme para microinterruptor		
Para modelos:	FC101, FC101E, FC241E, FC241G, FC61, FC61E, FCV101, FCV101-CSA, FCV101DM, FCV101DM-CSA, FCV101DS, FCV101DS-CSA, FCV101E, FCV101EDM, FCV101EDM-UL, FCV101EDS, FCV101EDS-UL, FCV101E-UL, FCV141, FCV141-CSA, FCV141DM, FCV141DS, FCV141DS-CSA, FCV141E, FCV141EDM, FCV141EDS, FCV241E, FCV241EDM, FCV241EDM-UL, FCV241EDS, FCV241EDS-UL, FCV241E-UL, FCV241G, FCV241G-CSA, FCV241GDM, FCV241GDM-CSA, FCV241GDS, FCV241GDS-CSA, FCV401DM, FCV401DM-CSA, FCV401EDM, FCV401EDM-UL, FCV61, FCV61-CSA, FCV61DM, FCV61DM-CSA, FCV61DS, FCV61DS-CSA, FCV61E, FCV61EDM...(Otros modelos se puede ver en la tienda web)		



			
1			
código	691141	referencia	36G7140
descripción	resorte para microinterruptor		
Para modelos:	1A1BR1E, 1A1BR1G, 1A1BR1GA, 1A1BR2E, 1A1BR2EA, 1A1BR2G, 1A1BR2GA, 1D1BR1E, 1D1BR1G, 1D1BR1GA, 1D1BR2E, 1D1BR2EA, 1D1BR2G, 1D1BR2GA, 2A1BR1G, 2A1BR1GA, 2A1BR2G, 2A1BR2GA, 2D1BR1G, 2D1BR1GA, 2D1BR2G, 2D1BR2GA, FC101, FC101E, FC241, FC241E, FC241G, FC61, FC61E, FCV101, FCV101-CSA, FCV101DM, FCV101DM-CSA, FCV101DS, FCV101DS-CSA, FCV101E, FCV101EDM, FCV101EDM-UL, FCV101EDS, FCV101EDS-UL, FCV101E-UL, FCV141, FCV141-CSA, FCV141DM, FCV141DM-CSA, FCV141DS, FCV141DS-CSA, FCV141E, FCV141EDM, FCV141EDS...(Otros modelos se puede ver en la tienda web)		

			
1			
código	516249	referencia	36G1720
descripción	tornillo de cabeza hexagonal rosca M5 EC 8		
Para modelos:	LT10R, LT20F, LT25F		

interruptores posicionales

PIZZATO

serie FR

			
1			
código	345337	referencia	32W3251
descripción	interruptor de posición plástico 1NO/1NC 400V 3A L 83mm An 31mm H 31mm protección IP67 fuerza de accionamiento: 900g unión roscada PG11 distancia de sujeción 20mm		
Para modelos:	091FR1E, 091FR1EA, 091FR1ED, 091FR1EX, 0A1FR1E, 0A1FR1ED, 0D1FR1E, 0D1FR1ED, 191BR1GA, 191BR2EA, 191BR2GA, 191FR2E, 191FR2ED, 1A1BR1E, 1A1BR1G, 1A1BR1GA, 1A1BR2E, 1A1BR2EA, 1A1BR2G, 1A1BR2GA, 1A1FR2E, 1A1FR2ED, 1D1BR1E, 1D1BR1G, 1D1BR1GA, 1D1BR2E, 1D1BR2EA, 1D1BR2G, 1D1BR2GA, 1D1FR2ED, 1G1BR1E, 291BR1GA, 291BR2EA, 291BR2GA, 2A1BR1E, 2A1BR1G, 2A1BR1GA, 2A1BR2E, 2A1BR2EA, 2A1BR2G, 2A1BR2GA, 2D1BR1E, 2D1BR1G, 2D1BR1GA, 2D1BR2E, 2D1BR2EA, 2D1BR2G, 2D1BR2GA, 71ARE, 71RA...(Otros modelos se puede ver en la tienda web)		

interruptores de sistema ROLD

			
1			
código	346251	referencia	33Q6440
descripción	disco giratorio naranja/verde ø arandela 20.6mm		
Para modelos:	KD100, KD100A, KD100PSD, KD130, KD130A, KD37, KD37PS, KD37-VERS.112009, KD40, KD40LUX, KD40PS, KD40-VERS.112009, KD60, KD60M, KD60MA, KD60MPS, KD60MPSA, KD60PS, KD60PSD, KD85, KD85A, KD85PS, KD85PSA, KN1100, KN1100SD, KN11PSDD, KN35, KN37, KN37PS, KN40, KN40PS, KN40PSD, KN50, KN50M, KN50MPS, KN50PS, KN50PSD, KN50PSDD, KN80, KN800, KN800PSD, KN80PS, N100D, N100S, N100VD, N100VS, N38D, N38S, N38VD, N38VS...(Otros modelos se puede ver en la tienda web)		

			
1			
código	345720	referencia	32W4150
descripción	elemento de conmutación 2NO 250V 16A empalme conector Faston 6,3mm		
Para modelos:	KD100, KD100A, KD100PSD, KD130, KD130A, KD37, KD37PS, KD37-VERS.112009, KD40, KD40LUX, KD40PS, KD40-VERS.112009, KD60, KD60M, KD60MA, KD60MPS, KD60MPSA, KD60PS, KD60PSD, KD85, KD85A, KD85PS, KD85PSA, KN1100, KN1100SD, KN11PSDD, KN35, KN37, KN37PS, KN40, KN40PS, KN40PSD, KN50, KN50M, KN50MPS, KN50PS, KN50PSD, KN50PSDD, KN80, KN800, KN800PSD, KN80PS, N100D, N100S, N100VD, N100VS, N38D, N38S, N38VD, N38VS...(Otros modelos se puede ver en la tienda web)		

			
1			
código	346817	referencia	32W1630
descripción	tecla ø 23mm blanco		
Para modelos:	LT25F		

			
1			
código	346221	referencia	32W4260
descripción	tecla tamaño 23x23mm verde CON.-DESC. con lente		
Para modelos:	KD100, KD100A, KD100PSD, KD130, KD130A, KD37, KD37PS, KD37-VERS.112009, KD40, KD40LUX, KD40PS, KD40-VERS.112009, KD60, KD60M, KD60MA, KD60MPS, KD60MPSA, KD60PS, KD60PSD, KD85, KD85A, KD85PS, KD85PSA, KN1100, KN1100SD, KN11PSDD, KN35, KN37, KN37PS, KN40, KN40PS, KN40PSD, KN50, KN50M, KN50MPS, KN50PS, KN50PSD, KN50PSDD, KN80, KN800, KN800PSD, KN80PS, N100D, N100S, N100VD, N100VS, N38D, N38S, N38VD, N38VS...(Otros modelos se puede ver en la tienda web)		

			
1			
código	346222	referencia	3063320
descripción	tecla tamaño 23x23mm verde START		
Para modelos:	KD37, KD37PS, KD37-VERS.112009, KD40, KD40LUX, KD40PS, KD40-VERS.112009, KD60, KD60M, KD60MA, KD60MPS, KD60MPSA, KD60PS, KD60PSD, KD85, KD85A, KN35, KN37, KN37PS, KN40, KN40PS, KN40PSD, KN50, KN50M, KN50MPS, KN50PS, KN50PSD, KN50PSDD, KN80, KN80PS		



1			
código	345130	referencia	3040850
descripción	unidad de pulsador 1NO 250V 16A empalme conector Faston 6,3mm		



1			
código	347193	referencia	3040850
descripción	unidad de pulsador 1NO 250V 16A empalme conector Faston 6,3mm		

interruptores de flotador



1			
código	403292	referencia	6300787
descripción	interruptor de flotador 1NO ø 12mm montaje ø 8mm 24V 0.2A conector longitud del cable 880mm 1 polos		
Para modelos:	FX101E3, FX101E3C, FX101E3C-VERS.022014, FX101E3R, FX101E3R-VERS.022014, FX101E3-VERS.022014, FX101G3, FX101G3C, FX101G3C-VERS.022014, FX101G3R, FX101G3R-VERS.022014, FX101G3CR, FX10G3CR-VERS.022014, FX10E3CR, FX10E3CR-VERS.022014, FX10G3CR, FX10G3CR-VERS.022014, FX122E3, FX122E3C, FX122E3T, FX122E3T-VERS.022014, FX122G3, FX122G3C, FX122G3T, FX122G3T-VERS.022014, FX12E3CT, FX12E3CT-VERS.022014, FX12G3CT, FX12G3CT-VERS.022014, FX201E3, FX201E3P, FX201E3P-VERS.022014, FX201E3-VERS.022014, FX201G3P, FX201G3-VERS.022014, FX202E3, FX202E3-230V-3-50Hz-60Hz, FX202E3-230V-3-50Hz-60Hz-VERS.022014, FX202E3-VERS.022014, FX202G3, FX202G3-VERS.022014, FX61E3, FX61E3C, FX61E3CR, FX61E3CR-VERS.022014, FX61E3C-VERS.022014, FX61E3R, FX61E3R-VERS.022014, FX61E3-VERS.022014, FX61G3, FX61G3C...(Otros modelos se puede ver en la tienda web)		

conmutadores de levas

conect./desc.



1			
código	301115	referencia	3168540
descripción	conmutador de levas 2 posiciones de conmutación 2NO secuencia de conmutación 0-1 16A eje ø 6x4,6mm eje L 23mm empalme conector Faston 6,3mm		
Para modelos:	091FR11, 091FR11-VERS.032012, 191FR21, 191FR21-VERS.032012, 6043840, 6043970		



1			
código	300088	referencia	32W3830
descripción	conmutador de levas 2 posiciones de conmutación 4NO secuencia de conmutación 0-1 16A eje ø 6x4,6mm eje L 23mm empalme conector Faston 6,3mm cerámica		
Para modelos:	0M0BR1E, 0M0FR1E, 0M0FT1E, 0M0FT2E, 0M0FT4E, 0M0FT5E, 0M0GR1E, 0M0GR2E, 1M0FR2E, 1M0FT1E, 1M0FT2E, 1M0FT3E, 1M0FT4E, 1M0FT5E, 1M0FT6E, 2M0FT1E, 2M0FT2E, 2M0FT3E, 2M0FT4E, 2M0FT5E, 2M0FT6E		



1			
código	300020	referencia	32W0490 32W3610
descripción	conmutador de levas 4 posiciones de control 2NO secuencia de conmutación 0-1-0-1 16A eje ø 6x4,6mm eje L 23mm empalme atornillado cerámica		
Para modelos:	04WFR3ED, 06WFR3GD, 08WFR4ED, 091FR1ED, 091FR1GD, 091FR3ED, 091FR3GD, 0A1FR1ED, 0A1FR1GD, 0A1FR1GD-VERS.2004, 0B1FR1GD, 0D1FR1ED, 0D1FR1GD, 0D1FR1GD-VERS.2004, 0G0FR3ED, 0G1FR3GD, 10WFR4GD, 191FR2ED, 191FR2GD, 191FR4ED, 191FR4GD, 1A1FR2ED, 1A1FR2GD, 1A1FR2GD-VERS.2004, 1A1PI2G, 1A1PI2GA, 1D1FR2ED, 1D1FR2GD, 1D1FR2GD-VERS.2004, 1D1PI2G, 1D1PI2GA, 1G1FR4GD, 291PI3G, 2A1PI3G, 2D1PI3G, FC101, FC101E, FC241, FC241E, FC241G, FC61, FC61E, L100, L80		
accesorios para	300020		
	código	110135	referencia —
		roseta pomo hasta ø 52mm	
	código	110231	referencia —
		pomo interruptor 0-1-0-1 T máx°C°C ø 50mm eje ø 6x4,6mm parte plana arriba negro	

5 posiciones



1			
código	300147	referencia	32W0510
descripción	conmutador de levas 5 posiciones de control 1NO/2CO secuencia de conmutación 0-1-2-3-4 16A eje ø 6x4,6mm eje L 23mm empalme atornillado 5 posiciones		



1

código	300149	referencia	32W1050
descripción	conmutador de levas 5 posiciones de control 2NO/2CO secuencia de conmutación 0-1-2-3-4 32A eje ø 6x4,6mm eje L 23mm empalme atornillado 5 posiciones cerámica		
Para modelos:	04WPE4V, 070E, 071E, 08WPE4V, 090E, 090PE4, 091E, 0A0PE4, 0D0PE4, 190PE4, 191PE4E, 1A0PE4, 1A1PE4E, 1A1PEFTE, 1D0PE4, 1D1PE4E, 30CPSE, 70CPE, 71E, 71PIE15, 71PIE15A, 90CPE, 91PIE15, 91PIE15A		



1

código	300105	referencia	32W3260
descripción	conmutador de levas 5 posiciones de control 3NO/1CO secuencia de conmutación 0-1-2-3-4 32A eje ø 6x4,6mm eje L 23mm empalme atornillado 5 posiciones cerámica		
Para modelos:	0A1CP1E, 0D1CP1E, 0G1CP1E, 0G1CP1E-VERS.2004, 191PI2E, 191PI2EA, 1A1PI2E, 1A1PI2EA, 1D1PI2E, 1D1PI2EA, 1G1PI1E, 31PIE6		



1



código	300133	referencia	32w0520
descripción	conmutador de levas 5 posiciones secuencia de conmutación 0-1-2-3-4 eje ø 6x4,6mm empalme borne roscado 3 polos		

7 posiciones



1

código	300025	referencia	32W0760 32W1840
descripción	conmutador de levas 7 posiciones de conmutación 1NO/2CO secuencia de conmutación 0-1-2-3-4-5-6 16A eje ø 6x4,6mm eje L 23mm empalme atornillado 7 posiciones cerámica		
Para modelos:	030E, 031E, 0G0PE1, 0G0PE2, 0G1PE2, 1G0PE1, 1G0PE2, 1G1PE1E, 1G1PE1EV, 1G1PE2, 1G1PE2E, 1G1PE2EV, 2G0PE1, 2G0PE2, 2G1PE1E, 2G1PE1EV, 2G1PE2E, 2G1PE2EV, 31TCE, 32TCE		

accesorios para	300025			
	código	112172	referencia	—
	pomo universal ø 70mm negro sin adaptador/símbolo			
	código	112213	referencia	—
	símbolo para pomo plata interruptor 7 posiciones T máx°C ø ext. 63mm int.ø 45.5mm			
	código	112311	referencia	—
	adaptador de pomo eje ø 6x4,6mm L 0mm con muelle			



1

código	300106	referencia	32W2920
descripción	conmutador de levas 7 posiciones de conmutación 1NO/2CO secuencia de conmutación 0-1-2-3-4-5-6 32A eje ø 6x4,6mm eje L 23mm empalme atornillado 7 posiciones parte plana arriba		
Para modelos:	60SME		

3 posiciones de conmutación



1

código	345171	referencia	3041660	
descripción	conmutador de levas 3-posiciones de conmutación 3NO secuencia de conmutación 0-1-2 16A eje ø 6x4,6mm eje L 26mm empalme conector Faston 6,3mm cerámica			
Para modelos:	FC1011E, FC1011G, FC1221E, FC1221G, FC611E, FC611G			
accesorios para	345171			
	código	112340	referencia	—
	pomo interruptor marca cero T máx°C margen de trabajo°C ø 40mm eje ø 6x4,6mm parte plana izquierdo negro			



4 posiciones de conmutación



1

código	345996	referencia	32W1440
descripción	conmutador de levas		
Para modelos:	191FAAE, 191FAE, 191PE4E, 1A1PE4E, 1A1PEFTE, 1A1FBE, 1D1PE4E, 1D1FBE, 71E, 71GE, 71GEGG, FS30E		

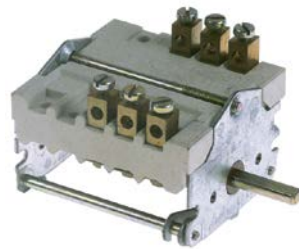

1

código	300215	referencia	32W0080
descripción	conmutador de levas 2 posiciones de conmutación secuencia de conmutación 0-1 3 polos temperatura ambiente máx. 318°C		



1

código	300010	referencia	32Z0540
descripción	conmutador de levas 4 posiciones de control 2NO/2CO secuencia de conmutación 0-1-2-3 16A eje ø 6x4,6mm eje L 23mm empalme conector Faston 6,3mm cerámica		

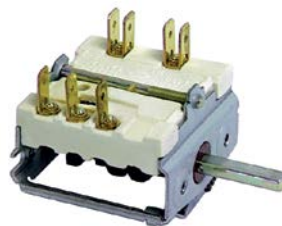

1

código	300122	referencia	32W0980
descripción	interruptor auxiliar secuencia de conmutación 0-1-2-3 eje ø 6x4,6mm empalme conector Faston 2 polos		
Para modelos:	F60P, F60PR, F60T, F80P, F80PR, L100, L40, L40S, L45, L60, L80		



1

código	301144	referencia	3162280
descripción	conmutador de levas 4 posiciones de control 6NO secuencia de conmutación 0-1-2-3 16A eje ø 6x4,6mm eje L 23mm empalme conector Faston 6,3mm plástico		
Para modelos:	04WCP1EM, 06WCP1GM, 091CP1E, 091CP1G, 0G1CP1EC, 0G1CP1E-VERS.2004, 0G1CP1G-VERS.2004, 191CP1G, 191CP2G, 1G1CP1G-VERS.2004, 1G1CP2G-VERS.2004, 6040090, 6040310, 6043850, 6043980		

conmutadores giratorios

BRETER

conmutadores giratorios



1

código	346917	referencia	32W2420
descripción	conmutador giratorio 2 0-1 juegos de contactos 4 400V 20A eje ø 5x5mm eje cuadrado con pomo empalme atornillado		

interruptor auxiliar

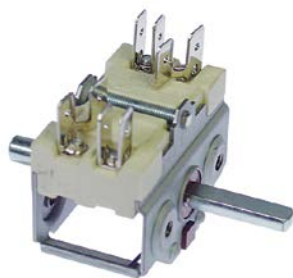

1

código	301153	referencia	32W2550
descripción	conmutador de levas 2 posiciones de conmutación 2NO 16A secuencia de conmutación 0-1 eje ø 6x4,6mm eje L 23mm empalme conector Faston 6,3mm cerámica		
Para modelos:	030FE1, 091FE28, 30F1, 30FES2, 30FS2, 70F1, 70FE, 70FE1, 70FES2, 71F2, 71FE2, 91F210		

LOVATO



1

código	346178	referencia	32W1200
descripción	conmutador giratorio 2 0-1 juegos de contactos 2 tipo GN209479U 690V 20A eje ø 6x6mm eje L 23.5mm eje cuadrado empalme atornillado		



interruptores magnéticos

37x16mm

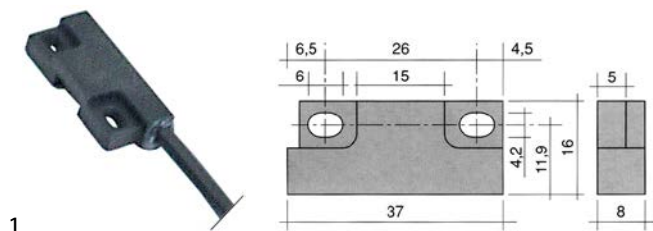

código	345600	referencia	32V5740 32W2160
---------------	--------	-------------------	--------------------

descripción interruptor magnético L 37mm An 16mm 1NO 250V 0.2A P máx. 50W empalme cable longitud del cable 960mm

Para modelos: BX101E, BX101E-VERS.122013, BX101G, BX101G-VERS.122013, BX122E, BX122E-VERS.122013, BX122G, BX122G-VERS.122013, BX61E, BX61E-VERS.122013, BX61G, BX61G-VERS.122013, BX82E, BX82E-VERS.122013, BX82G, BX82G-VERS.122013, FM1011E1, FM1011E1-VERS.2006, FM1011E2, FM1011E2-VERS.2006, FM1011E3, FM1011E3-VERS.2006, FM1011G1, FM1011G1-VERS.2006, FM1011G2, FM1011G2-VERS.2006, FM1011G3, FM1011G3-VERS.2006, FM1221E1, FM1221E1-VERS.2006, FM1221E2, FM1221E2-VERS.2006, FM1221E3, FM1221E3-VERS.2006, FM1221G1, FM1221G1-VERS.2006, FM1221G2, FM1221G2-VERS.2006, FM1221G3, FM1221G3-VERS.2006, FM2011E2-VERS.2006, FM2011E3-VERS.2006, FM2011G2-VERS.2006, FM2011G3-VERS.2006, FM2021E1, FM2021E2, FM2021E2-VERS.2006, FM2021E3, FM2021E3-VERS.2006, FM2021G1...(Otros modelos se puede ver en la tienda web)

accesorios para	345600
------------------------	--------

	código	519049	referencia	3023650 32W0870 32W1680
imán ømm L 63mm H 10.7mm An 18.8mm dist. del agujero 52mm M2 agujero ø 2mm				

51x16mm

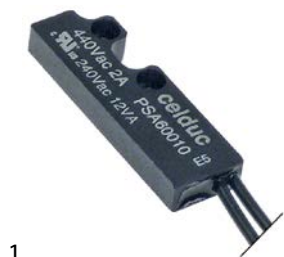

código	348168	referencia	3022950
---------------	--------	-------------------	---------

descripción interruptor magnético L 51mm An 16mm 1NO 240V 2A P máx. 12W longitud del cable 350mm

Para modelos: DK112, DK351M, DK352, DK552, DP10, DP25

65x20mm

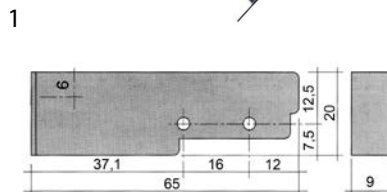
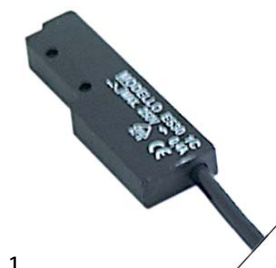

código	345116	referencia	32W1210
---------------	--------	-------------------	---------

descripción interruptor magnético L 65mm An 20mm 1NO 250V 0.4A P máx. 100W empalme cable longitud del cable 3000mm

accesorios para 345116

	código	345399	referencia	—
imán ø 3.3mm L 40mm H 8mm An 13mm dist. del agujero 30mm M3				

M10x0,75



código	348024	referencia	32W1890 32W3460
---------------	--------	-------------------	--------------------

descripción interruptor magnético 1NO 250V 1A P máx. 10W empalme Faston 6,3mm longitud del cable 2000mm

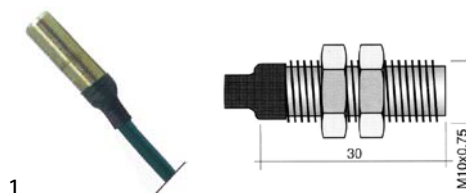

código	345632	referencia	32W3200 32W3240 32W8650
---------------	--------	-------------------	-------------------------------

descripción interruptor magnético rosca M10x0,75 1NO 250V 0.5A P máx. 50W empalme cable longitud del cable 2000mm tipo 102

Para modelos: C165D, C165S, C165VD, C165VS, C207D, C207D-VERS.2006, C207S, C207S-VERS.2006, C207VD, C207VD-VERS.2006, C207VS, C207VS-VERS.2006, C304AD, C304AD-VERS.2006, C304AS, C304AS-VERS.2006, C304AVD, C304AVD-VERS.2006, C304AVS, C304AVS-VERS.2006, C304D, C304D-VERS.2006, C304S, C304S-VERS.2006, C304VD, C304VD-VERS.2006, C304VS, C304VS-VERS.2006, C92D-VERS.2006, C92S-VERS.2006, C92VD-VERS.2006, C92VS-VERS.2006, CS243D, CS243D-VERS.2006, CS243S, CS243S-VERS.2006, CS243VD, CS243VD-VERS.2006, CS243VS, CS243VS-VERS.2006, CS370AD, CS370AD-VERS.2006, CS370AS, CS370AS-VERS.2006, CS370AVD, CS370AVD-VERS.2006, CS370AVS, CS370AVS-VERS.2006, CS370D, CS370D-VERS.2006...(Otros modelos se puede ver en la tienda web)

accesorios para 345632

	código	100779	referencia	—
tuerca rosca M10x0,75 H 3mm EC 14 inox UE 2 pzs				



accesorios			
imanes			
1			
código	691178	referencia	3008810 3112370
descripción	imán ø 22mm Lmm H 7mm Anmm ø ext. 22mm M5		
Para modelos:	FC1011E, FC1011G, FC1221E, FC1221G, FC611E, FC611G, FM1011E1, FM1011E1-VERS.2006, FM1011E2, FM1011E2-VERS.2006, FM1011E3, FM1011E3-VERS.2006, FM1011G1, FM1011G1-VERS.2006, FM1011G2, FM1011G2-VERS.2006, FM1011G3, FM1011G3-VERS.2006, FM1221E1, FM1221E1-VERS.2006, FM1221E2, FM1221E2-VERS.2006, FM1221E3, FM1221E3-VERS.2006, FM1221G1, FM1221G1-VERS.2006, FM1221G2, FM1221G2-VERS.2006, FM1221G3, FM1221G3-VERS.2006, FM2011E2-VERS.2006, FM2011E3-VERS.2006, FM2011G2-VERS.2006, FM2011G3-VERS.2006, FM2021E1, FM2021E2, FM2021E2-VERS.2006, FM2021E3, FM2021E3-VERS.2006, FM2021G1, FM2021G2, FM2021G2-VERS.2006, FM2021G3, FM2021G3-VERS.2006, FM611E1, FM611E1-VERS.2006, FM611E2, FM611E2-VERS.2006, FM611E3, FM611E3-VERS.2006... (Otros modelos se puede ver en la tienda web)		

1			
código	345336	referencia	3210010
descripción	imán ø 4.8mm L 63mm H 11mm An 18.8mm dist. del agujero 51mm M4		
Para modelos:	LP151, LP202, LP202HC, LP302, LP302HC, LP402, LP402HC, LP402V, LPG300		

1			
código	345398	referencia	32V0080
descripción	imán ømm L 36mm H 8mm An 13mm dist. del agujero 20mm M3 agujero ø 3mm		

1			
código	519049	referencia	3023650 32W0870 32W1680
descripción	imán ømm L 63mm H 10.7mm An 18.8mm dist. del agujero 52mm M2 agujero ø 2mm		
Para modelos:	C165D, C165S, C165VD, C165VS, C207D, C207D-VERS.2006, C207S, C207S-VERS.2006, C207VD, C207VD-VERS.2006, C207VS, C207VS-VERS.2006, C304AD, C304AD-VERS.2006, C304AS, C304AS-VERS.2006, C304AVD, C304AVD-VERS.2006, C304AVS, C304AVS-VERS.2006, C304D, C304D-VERS.2006, C304S, C304S-VERS.2006, C304VD, C304VD-VERS.2006, C304VS, C304VS-VERS.2006, C92D-VERS.2006, C92S-VERS.2006, C92VD-VERS.2006, C92VS-VERS.2006, CS243D, CS243D-VERS.2006, CS243S, CS243S-VERS.2006, CS243VD, CS243VD-VERS.2006, CS243VS, CS243VS-VERS.2006, CS370AD, CS370AD-VERS.2006, CS370AS, CS370AS-VERS.2006, CS370AVD, CS370AVD-VERS.2006, CS370AVS, CS370AVS-VERS.2006, CS370D, CS370D-VERS.2006... (Otros modelos se puede ver en la tienda web)		
accesorios para	519049		
	código	560095	referencia
		tornillos de chapa ø 2.9mm L 9.5mm inox UE 20 pzs DIN 7981/ISO 7049 ø cabezal 5.6mm cabeza gota de sebo	

aparatos de mando y aviso

BRETER

interruptor completo			
1			
código	345718	referencia	32W1640
descripción	pulsador negro 1NC/1NO		
Para modelos:	71AR, 71ARE, 71RA, 91AR, 91ARE, 91RA		

1			
código	345717	referencia	32W1650
descripción	pulsador verde 1NC/1NO		
Para modelos:	71AR, 71ARE, 71RA, 91AR, 91ARE, 91RA		



ELFIN

interruptor completo



1

código	347947	referencia	32Z8470
descripción	selector giratorio medida de montaje ø22mm 2NO/2NC secuencia de conmutación 0-1-2 negro		
Para modelos:	C207D, C207S, C207VD, C207VS, C304AD, C304AS, C304AVD, C304AVS, C304D, C304S, C304VD, C304VS, CS243D, CS243S, CS243VD, CS243VS, CS370AD, CS370AS, CS370AVD, CS370AVS, CS370D, CS370S, CS370VD, CS370VS, CS466AD, CS466AS, CS466AVD, CS466AVS, CS466D, CS466S, CS466VD, CS466VS, N303D, N303S, N303VD, N303VS, N354D, N354S, N354VD, N354VS, N506D, N506S, N506VD, N506VS, N607D, N607S, N607VD, N607VS, N760D, N760S...(Otros modelos se puede ver en la tienda web)		

LOVATO



1

código	301171	referencia	32W3330
descripción	bloque de contacto LAVATO 8 LM2T-C10 1NC máx. 690V 10A		
Para modelos:	10CP1EA, 10CP1GA, 10CP1IA, 12CP1EA, 12CP1GA, 12CP1IA, 18CP2EA, 18CP2GA, 18CP2IA, 191BR1GA, 191BR2EA, 191BR2GA, 1A1BR1GA, 1A1BR2EA, 1A1BR2GA, 1D1BR1GA, 1D1BR2EA, 1D1BR2GA, 2091SCP, 291BR1GA, 291BR2EA, 291BR2GA, 2A1BR1GA, 2A1BR2EA, 2A1BR2GA, 2D1BR1GA, 2D1BR2EA, 2D1BR2GA, BRE21HD, BRE31HD, PIER06HD, PIER10HD, PIER15HD		



1

código	301170	referencia	32W3320
descripción	bloque de contacto LAVATO 8 LM2T-C10 1NO máx. 690V 10A		
Para modelos:	10CP1EA, 10CP1GA, 10CP1IA, 12CP1EA, 12CP1GA, 12CP1IA, 18CP2EA, 18CP2GA, 18CP2IA, 191BR1GA, 191BR2EA, 191BR2GA, 1A1BR1GA, 1A1BR2EA, 1A1BR2GA, 1D1BR1GA, 1D1BR2EA, 1D1BR2GA, 291BR1GA, 291BR2EA, 291BR2GA, 2A1BR1GA, 2A1BR2EA, 2A1BR2GA, 2D1BR1GA, 2D1BR2EA, 2D1BR2GA, BRE21HD, BRE31HD, PIER06HD, PIER10HD, PIER15HD		

APARATOS DE MANDO Y AVISO ANGELO-PO

serie plástico

soportes para bloque de contactos



1

código	301169	referencia	32W3310
descripción	soporte para bloque de contactos		
Para modelos:	10CP1EA, 10CP1GA, 10CP1IA, 12CP1EA, 12CP1GA, 12CP1IA, 18CP2EA, 18CP2GA, 18CP2IA, 191BR1GA, 191BR2EA, 191BR2GA, 1A1BR1GA, 1A1BR2EA, 1A1BR2GA, 1D1BR1GA, 1D1BR2EA, 1D1BR2GA, 291BR1GA, 291BR2EA, 291BR2GA, 2A1BR1GA, 2A1BR2EA, 2A1BR2GA, 2D1BR1GA, 2D1BR2EA, 2D1BR2GA, BRE21HD, BRE31HD, PIER06HD, PIER10HD, PIER15HD		

serie metal

teclas



1

código	301197	referencia	37Q4030 37Q7600
descripción	cubierta protectora transparente ø ext. 34mm H 16mm para tecla		
Para modelos:	10CP1EA, 10CP1GA, 10CP1IA, 12CP1EA, 12CP1GA, 12CP1IA, 18CP2EA, 18CP2GA, 18CP2IA, 191BR1GA, 191BR2EA, 191BR2GA, 1A1BR1GA, 1A1BR2EA, 1A1BR2GA, 1D1BR1GA, 1D1BR2EA, 1D1BR2GA, 291BR1GA, 291BR2EA, 291BR2GA, 2A1BR1GA, 2A1BR2EA, 2A1BR2GA, 2D1BR1GA, 2D1BR2EA, 2D1BR2GA, 71AR, 71ARE, 71RA, 91AR, 91ARE, 91RA, BRE21HD, BRE31HD, PIER06HD, PIER10HD, PIER15HD		



1

código	301196	referencia	32W3300
descripción	tecla medida de montaje ø22mm negro flecha		
Para modelos:	10CP1EA, 10CP1GA, 10CP1IA, 12CP1EA, 12CP1GA, 12CP1IA, 18CP2EA, 18CP2GA, 18CP2IA, 191BR1GA, 191BR2EA, 191BR2GA, 1A1BR1GA, 1A1BR2EA, 1A1BR2GA, 1D1BR1GA, 1D1BR2EA, 1D1BR2GA, 291BR1GA, 291BR2EA, 291BR2GA, 2A1BR1GA, 2A1BR2EA, 2A1BR2GA, 2D1BR1GA, 2D1BR2EA, 2D1BR2GA, BRE21HD, BRE31HD, PIER06HD, PIER10HD, PIER15HD		



TELEMECANIQUE (EFA)

serie XA2

interruptor completo



1

código	345592	referencia	32W2150
descripción	selector giratorio medida de montaje ø22mm 1NC/1NO completo secuencia de conmutación 0-1-2		
Para modelos:	LC100, LC100-VERS.2001, LC130, LC130-VERS.2001, LC80		



1

código	345591	referencia	32Z8670
descripción	selector giratorio medida de montaje ø22mm completo		
Para modelos:	C165D, C165S, C165VD, C165VS, C207D, C207S, C207VD, C207VS, C304AD, C304AS, C304AVD, C304AVS, C304D, C304S, C304VD, C304VS, CS243D, CS243S, CS243VD, CS243VS, CS370AD, CS370AS, CS370AVD, CS370AVS, CS370D, CS370S, CS370VD, CS370VS, CS466AD, CS466AS, CS466AVD, CS466AVS, CS466D, CS466S, CS466VD, CS466VS, LC100, LC100-VERS.2001, LC130, LC130-VERS.2001, LC80, LP124, LP124S-VERS.052006, LP124V, LP124V-VERS.052006, LP124VS-VERS.052006, LP124V-VERS.052006, LP84, LP84S-VERS.052006, LP84V...(Otros modelos se puede ver en la tienda web)		

otros



1

código	349001	referencia	32W1700
descripción	elemento de señalización medida de montaje ø22mm amarillo		
Para modelos:	C165D, C165S, C165VD, C165VS, C207D, C207S, C207VD, C207VS, C304AD, C304AS, C304AVD, C304AVS, C304D, C304S, C304VD, C304VS, CS243D, CS243S, CS243VD, CS243VS, CS370AD, CS370AS, CS370AVD, CS370AVS, CS370D, CS370S, CS370VD, CS370VS, CS466AD, CS466AS, CS466AVD, CS466AVS, CS466D, CS466S, CS466VD, CS466VS, LP124, LP124V, LP84, LP84V		

codificadores y potenciómetros



1

código	402322	referencia	3051070
descripción	codificador		
Para modelos:	BX101E, BX101G, BX122E, BX122G, BX61E, BX61G, BX82E, BX82G, FM1011E1-VERS.2006, FM1011E2-VERS.2006, FM1011E3-VERS.2006, FM1011G1-VERS.2006, FM1011G2-VERS.2006, FM1011G3-VERS.2006, FM1221E1-VERS.2006, FM1221E2-VERS.2006, FM1221E3-VERS.2006, FM1221G1-VERS.2006, FM1221G2-VERS.2006, FM1221G3-VERS.2006, FM2011E2-VERS.2006, FM2011E3-VERS.2006, FM2011G2-VERS.2006, FM2011G3-VERS.2006, FM2021E2-VERS.2006, FM2021E3-VERS.2006, FM2021G2-VERS.2006, FM2021G3-VERS.2006, FM423E1, FM423E2, FM611E1-VERS.2006, FM611E2-VERS.2006, FM611E3-VERS.2006, FM611G1-VERS.2006, FM611G2-VERS.2006, FM611G3-VERS.2006, FM721E1-VERS.2006, FM721E2-VERS.2006, FM721E3-VERS.2006, FM721G1-VERS.2006, FM721G2-VERS.2006, FM721G3-VERS.2006		



1

código	300272	referencia	3104220 6300966
descripción	codificador eje ø 6x4,6mm para horno a vapor combinado		
Para modelos:	BX101E-VERS.122013, BX101G-VERS.122013, BX122E-VERS.122013, BX122G-VERS.122013, BX61E-VERS.122013, BX61G-VERS.122013, BX82E-VERS.122013, BX82G-VERS.122013, FX101E1, FX101E1R, FX101E2, FX101E2C, FX101E2C-VERS.032014, FX101E2R, FX101E2R-VERS.032014, FX101E2-VERS.032014, FX101E3, FX101E3C, FX101E3C-VERS.022014, FX101E3R, FX101E3R-VERS.022014, FX101E3-VERS.022014, FX101G1, FX101G1R, FX101G2, FX101G2C, FX101G2C-VERS.032014, FX101G2R, FX101G2R-VERS.032014, FX101G2-VERS.032014, FX101G3, FX101G3C, FX101G3C-VERS.022014, FX101G3R, FX101G3R-VERS.022014, FX101G3-VERS.022014, FX10E2CR, FX10E2CR-VERS.032014, FX10E3CR, FX10E3CR-VERS.022014, FX10G2CR, FX10G2CR-VERS.032014, FX10G3CR, FX10G3CR-VERS.022014, FX122E1, FX122E2, FX122E2C, FX122E2T, FX122E2T-VERS.032014, FX122E3...(Otros modelos se puede ver en la tienda web)		



1

código	300230	referencia	32V5580
descripción	potenciómetro		
Para modelos:	FM1011E1, FM1011E2, FM1011E3, FM1011G1, FM1011G2, FM1011G3, FM1221E1, FM1221E2, FM1221E3, FM1221G1, FM1221G2, FM1221G3, FM2021E1, FM2021E2, FM2021E3, FM2021G1, FM2021G2, FM2021G3, FM611E1, FM611E2, FM611E3, FM611G1, FM611G2, FM611G3, FM721E1, FM721E2, FM721E3, FM721G1, FM721G2, FM721G3, FS611		



lámparas

lámparas de señalización

lámparas de señalización 2 piezas (lente y elemento)

elementos de señalización para casquillo tipo SRZ / SDK / SDY / SFK



código	359130	referencia	32W4220
descripción	elemento de señalización 230V claro empalme conector Faston 6,3mm ø 8mm		
Para modelos:	KD100, KD100A, KD100PSD, KD37, KD37PS, KD37-VERS.112009, KD40, KD40LUX, KD40PS, KD40-VERS.112009, KD60, KD60M, KD60MA, KD60MPS, KD60MPSA, KD60PS, KD60PSD, KD85, KD85A, KD85PS, KD85PSA, KN1100, KN1100SD, KN11PSDD, KN35, KN37, KN37PS, KN40, KN40PS, KN40PSD, KN50, KN50M, KN50MPS, KN50PS, KN50PSD, KN50PSDD, KN80, KN80M, KN800PSD, KN80PS		

lámparas de señalización completas

ø 6mm



código	359005	referencia	32W2250
descripción	lámpara de señalización ø 6mm 230V amarillo longitud del cable 400mm		
Para modelos:	FC101, FC1011E, FC1011G, FC101E, FC1221E, FC1221G, FC241, FC241E, FC241G, FC61, FC611E, FC611G, FC61E, FMS, FMSX		



código	359009	referencia	32W0450
descripción	lámpara de señalización ø 6mm 230V rojo longitud del cable 400mm con resistencia en serie		
Para modelos:	FC101, FC1011E, FC1011G, FC101E, FC1221E, FC1221G, FC241, FC241E, FC241G, FC61, FC611E, FC611G, FC61E		



código	359004	referencia	32W0101
descripción	lámpara de señalización ø 6mm 230V verde longitud del cable 400mm resis.a la temp. 106°C		
Para modelos:	FC101, FC1011E, FC1011G, FC101E, FC1221E, FC1221G, FC241, FC241E, FC241G, FC61, FC611E, FC611G, FC61E, FMS, FMSX		

ø 9mm



código	345598	referencia	32W2130
descripción	lámpara de señalización ø 9mm 400V amarillo empalme conector Faston 6,3mm resis.a la temp. 85°C		
Para modelos:	LC100, LC100-VERS.2001, LC130, LC130-VERS.2001, LC80, LF50, LF50E, LF50EM, LF50EMPS, LF50E-VERS.2007		



código	345597	referencia	32W2140
descripción	lámpara de señalización ø 9mm 400V verde empalme conector Faston 6,3mm resis.a la temp. 85°C		
Para modelos:	LC100, LC100-VERS.2001, LC130, LC130-VERS.2001, LC80, LF50, LF50E, LF50EM, LF50EMPS, LF50E-VERS.2007		

ø10mm

con casquillo roscado



código	359379	referencia	3106730 32W0790 32W0791
descripción	lámpara de señalización ø 10mm 230V amarillo empalme conector Faston 6,3mm casquillo portalámpara roscado		
Para modelos:	030BME, 030EBM, 030FE, 030FE1, 030FE1B, 030FTE, 030FTE, 030FTE, 031BME, 031EBM, 031FTE, 031FTE, 031FTE, 031FTE, 04WBM, 04WCP1EM, 04WFR3ED, 06WBR3E, 06WFR3GD, 06WFT1EV, 06WFT2EV, 06WFT3EV, 06WFT4EV, 06WFT6EV, 06WFT7EV, 070BME, 070FTE, 070FTE, 071BME, 071FTE, 071FTE, 071FTE, 071FTE, 08WFAA, 08WFAAE, 08WFR4ED, 08WFT1EV, 08WFT2EV, 08WFT3EV, 08WFT4EV, 08WFT6EV, 08WFT7EV, 090BM1E, 090BME, 090FT1E, 090FT2E, 090FT4E, 090FT5E, 090FT7E, 090FTE, 090FTE, 091BME, 091CP1E...(Otros modelos se puede ver en la tienda web)		



código	359995	referencia	32W3280
descripción	lámpara de señalización ø 10mm 230V claro empalme conector Faston 6,3mm		
Para modelos:	P5		





código	359380	referencia	32W1340
descripción	lámpara de señalización ø 10mm 230V rojo empalme conector Faston 6,3mm casquillo portalámpara roscado		





código	359378	referencia	3106710 32W1330 32W1331
descripción	lámpara de señalización ø 10mm 230V verde empalme conector Faston 6,3mm casquillo portalámpara roscado		
Para modelos:	030BME, 030E, 030EBM, 030FE, 030FE1, 030FE1B, 030FTE, 030FTE, 031BME, 031E, 031EBM, 031FTE, 031FTE, 031FTE, 04WB-MEV, 04WCP1EM, 04WFR3ED, 04WPE4V, 04WVT3RV, 06WBR3E, 06WCP1GM, 06WFR3GD, 06WFT1EV, 06WFT2EV, 06WFT3EV, 06WFT4EV, 06WFT6EV, 06WFT7EV, 070BME, 070E, 070FTE, 070FTE, 071BME, 071E, 071FTE, 071FTE, 071FTE, 08WCP1GM, 08WFAA, 08WFAAE, 08WFR4ED, 08WFT1EV, 08WFT2EV, 08WFT3EV, 08WFT4EV, 08WFT6EV, 08WFT7EV, 08WGREV, 08WPE4V, 090BM1E...(Otros modelos se puede ver en la tienda web)		

			
1			
código	359527	referencia	32W1562
descripción	lámpara de señalización ø 10mm 400V verde empalme conector Faston 6,3mm casquillo portalámpara roscado		
Para modelos:	031FTE04, 031FTE06, 070E, 070FTE04, 070FTE05, 071E, 071FTE04, 071FTE06, 08WFAAE, 090E, 090FTE04, 090FTE05, 091E, 091FTE04, 091FTE06, 0A0FT1E, 0A0FT2E, 0A0FT4E, 0A0FT5E, 0A0PE4, 0A1CP1E, 0D0FT1E, 0D0FT2E, 0D0FT4E, 0D0FT5E, 0D0PE4, 0D1CP1E, 0G0FT1E, 0G0FT2E, 0G0FT4E, 0G0FT5E, 0G0PE1, 0G0PE2, 0G1CP1E, 10WTPGE, 12WFAAA, 12WFAAE, 190BM2E, 191PI2E, 191PI2EA, 1A0BME, 1A0FT1E, 1A0FT2E, 1A0FT3E, 1A0FT4E, 1A0FT6E, 1A0PE4, 1A1PE4E, 1A1PEFTE, 1A1PI2E...(Otros modelos se puede ver en la tienda web)		

			
1			
código	346883	referencia	3106730 32W1551 6300651
descripción	lámpara de señalización ø 10mm 230V amarillo empalme conector Faston 6,3mm		
Para modelos:	031FTE04, 031FTE06, 070FTE04, 070FTE05, 071FTE04, 071FTE06, 090FTE04, 090FTE05, 091FTE04, 091FTE06, 0A0FT1E, 0A0FT2E, 0A0FT4E, 0A0FT5E, 0D0FT1E, 0D0FT2E, 0D0FT4E, 0D0FT5E, 0G0FT1E, 0G0FT2E, 0G0FT4E, 0G0FT5E, 0G0FT7E, 10WTPGE, 12WFAAA, 190BM2E, 1A0BME, 1A0FT1E, 1A0FT2E, 1A0FT3E, 1A0FT4E, 1A0FT6E, 1A1PE4E, 1A1PEFTE, 1A1FBE, 1D0BME, 1D0FT1E, 1D0FT2E, 1D0FT3E, 1D0FT4E, 1D0FT6E, 1D1PE4E, 1D1FBE, 1G0FT1E, 1G0FT2E, 1G0FT3E, 1G0FT4E, 1G0FT7E, 1G1FA0E, 1G1FA0EV...(Otros modelos se puede ver en la tienda web)		

			
1			
código	346881	referencia	3106720 32W1341 6300653
descripción	lámpara de señalización ø 10mm 230V rojo empalme conector Faston 6,3mm		

			
1			
código	360483	referencia	6300652
descripción	lámpara de señalización ø 10mm 230V verde empalme conector Faston 6,3mm longitud del cable 90mm con resistencia en serie para operación a 230 V casquillo portalámpara roscado		
Para modelos:	031FTE04, 031FTE06, 070E, 070FTE04, 070FTE05, 071E, 071FTE04, 071FTE06, 090E, 090FTE04, 090FTE05, 091E, 091FTE04, 091FTE06, 0A0FT1E, 0A0FT2E, 0A0FT4E, 0A0FT5E, 0A0PE4, 0A1CP1E, 0D0FT1E, 0D0FT2E, 0D0FT4E, 0D0FT5E, 0D0PE4, 0D1CP1E, 0G0FT1E, 0G0FT2E, 0G0FT4E, 0G0FT5E, 0G0FT7E, 0G0PE1, 0G0PE2, 0G1CP1E, 0G1PE2, 10WTPGE, 12WFAAA, 190BM2E, 191PI2E, 191PI2EA, 1A0BME, 1A0FT1E, 1A0FT2E, 1A0FT3E, 1A0FT4E, 1A0FT6E, 1A0PE4, 1A1PE4E, 1A1PEFTE, 1A1PI2E...(Otros modelos se puede ver en la tienda web)		

			
1			
código	359889	referencia	32W2080
descripción	lámpara de señalización ø 10mm 230V rojo empalme cable		
Para modelos:	AFC30MS, AFC30S, AFC35, AFT30MS, AFT30S, AFT30VMS, AFT30VS, AFT33MS, AFT33S, AFT35, AFT35VS		

con casquillo enchufable			
			
1			
código	359140	referencia	32W0790
descripción	lámpara de señalización ø 10mm amarillo 230V empalme conector Faston 6,3mm UE 1 pzs		

			
1			
código	359334	referencia	32W2440
descripción	lámpara de señalización ø 10mm amarillo 24V empalme conector Faston 6,3mm UE 1 pzs		

			
1			
código	359034	referencia	32W2240 32W2241
descripción	lámpara de señalización ø 10mm amarillo 400V empalme conector Faston 6,3mm UE 1 pzs		
Para modelos:	031FTE04, 031FTE06, 070FTE04, 070FTE05, 071FTE04, 071FTE06, 08WFAAE, 090FTE04, 090FTE05, 091FTE04, 091FTE06, 0A0FT1E, 0A0FT2E, 0A0FT4E, 0A0FT5E, 0D0FT1E, 0D0FT2E, 0D0FT4E, 0D0FT5E, 0G0FT1E, 0G0FT2E, 0G0FT4E, 0G0FT5E, 10WTPGE, 12WFAAA, 12WFAAE, 190BM2E, 1A0BME, 1A0FT1E, 1A0FT2E, 1A0FT3E, 1A0FT4E, 1A0FT6E, 1A1PE4E, 1A1PEFTE, 1A1FBE, 1D0BME, 1D0FT1E, 1D0FT2E, 1D0FT3E, 1D0FT4E, 1D0FT6E, 1D1PE4E, 1D1FBE, 1G0FT1E, 1G0FT2E, 1G0FT3E, 1G0FT4E, 1G1FA0E, 1G1FA0EV...(Otros modelos se puede ver en la tienda web)		

			
1			
código	359020	referencia	32W1550 32W1551
descripción	lámpara de señalización ø 10mm rojo 400V empalme conector Faston 6,3mm UE 1 pzs		
Para modelos:	0A1CP1E, 0D1CP1E, 0G1CP1E, 191PI2E, 191PI2EA, 1A1PI2E, 1A1PI2EA, 1D1PI2E, 1D1PI2EA, 1G1PI1E		

			
1			
código	359019	referencia	32W1560 32W1561
descripción	lámpara de señalización ø 10mm verde 400V empalme conector Faston 6,3mm UE 1 pzs		
Para modelos:	031FTE04, 031FTE06, 070E, 070FTE04, 070FTE05, 071E, 071FTE04, 071FTE06, 08WFAAE, 090E, 090FTE04, 090FTE05, 091E, 091FTE04, 091FTE06, 0A0FT1E, 0A0FT2E, 0A0FT4E, 0A0FT5E, 0A0PE4, 0A1CP1E, 0D0FT1E, 0D0FT2E, 0D0FT4E, 0D0FT5E, 0D0PE4, 0D1CP1E, 0G0FT1E, 0G0FT2E, 0G0FT4E, 0G0FT5E, 0G0PE1, 0G0PE2, 0G1CP1E, 10WTPGE, 12WFAAA, 12WFAAE, 1A0BME, 1A0FT1E, 1A0FT2E, 1A0FT3E, 1A0FT4E, 1A0FT6E, 1A0PE4, 1A1PE4E, 1A1PEFTE, 1A1PI2E, 1A1PI2EA, 1A1FBE, 1D0BME...(Otros modelos se puede ver en la tienda web)		



ø12mm

con casquillo roscado



código	359023	referencia	32W1380
descripción	lámpara de señalización ø 12mm 24V verde empalme conector Faston 6,3mm		

28,5x28,5mm

lámparas completas



código	359355	referencia	32W1250
descripción	lámpara de señalización medida de montaje 28,5x28,5mm 230V azul		



código	359352	referencia	32W1220
descripción	lámpara de señalización medida de montaje 28,5x28,5mm 230V claro		



código	359356	referencia	N/A
descripción	lámpara de señalización medida de montaje 28,5x28,5mm 230V rojo		



código	359353	referencia	32W1230
descripción	lámpara de señalización medida de montaje 28,5x28,5mm 230V verde		

30x11mm



código	359158	referencia	32W0550
descripción	lámpara de señalización medida de montaje 30x11mm 230V rojo empalme conector Faston 6,3mm resis.a la temp. 125°C		

30x22mm



código	359156	referencia	32W0270 32W0640
descripción	lámpara de señalización medida de montaje 30x22mm 230V amarillo empalme conector Faston 6,3mm resis.a la temp. 125/55°C tipo RL2		



código	359155	referencia	32W0680
descripción	lámpara de señalización medida de montaje 30x22mm 230V rojo empalme conector Faston 6,3mm resis.a la temp. 125°C tipo RL2		

33x10mm



código	359451	referencia	32W0720
descripción	lámpara de señalización medida de montaje 33,1x10,3mm 400V amarillo empalme conector Faston 6,3mm		

34x10mm



código	359899	referencia	32W0650
descripción	lámpara de señalización medida de montaje 34x10mm 380V rojo empalme conector Faston 6,3mm resis.a la temp. 120°C		

lámpade

bombillas incandescentes

para hornos

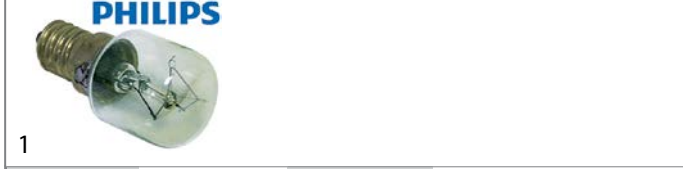

código	359610	referencia	32W0780
descripción	bombilla incandescente T máx 300°C casquillo E14 15W 230V ø 22mm L 47mm cristal L 20mm para lámpara de horno tipo Philips		



PHILIPS



1

código	359612	referencia	32W0210
descripción	bombilla incandescente T máx 300°C casquillo E14 25W 230V ø 25mm L 56mm cristal L 30mm para lámpara de horno tipo Philips		
Para modelos:	FC101, FC1011E, FC1011G, FC101E, FC1221E, FC1221G, FC241, FC241E, FC241G, FC61, FC611E, FC611G, FC61E, FCV101, FCV101-CSA, FCV101DM, FCV101DM-CSA, FCV101DS, FCV101DS-CSA, FCV101E, FCV101EDM, FCV101EDM-UL, FCV101EDS, FCV101EDS-UL, FCV101E-UL, FCV141, FCV141-CSA, FCV141DM, FCV141DM-CSA, FCV141DS, FCV141DS-CSA, FCV141E, FCV141EDM, FCV141EDS, FCV241, FCV241DM, FCV241DS, FCV241E, FCV241EDM, FCV241EDM-UL, FCV241EDS, FCV241EDS-UL, FCV241E-UL, FCV241G, FCV241G-CSA, FCV241GDM, FCV241GDM-CSA, FCV241GDS, FCV241GDS-CSA, FCV3EM...(Otros modelos se puede ver en la tienda web)		



1

código	359614	referencia	32W2350
descripción	bombilla incandescente T máx 300°C casquillo E27 230V 40W ø 45mm L 71mm cristal L 44mm UE 1 pzs		

lámparas halógenas

para portalámpara G4 / G6,35 / G9

OSRAM



1

código	357193	referencia	3030661
descripción	lámpara halógena casquillo G4 12V 20W resis.a la temp. 300°C OSRAM HALOSTAR OVEN		
Para modelos:	BX101E, BX101E-VERS.122013, BX101G, BX101G-VERS.122013, BX122E, BX122E-VERS.122013, BX122G, BX122G-VERS.122013, BX61E, BX61E-VERS.122013, BX61G, BX61G-VERS.122013, BX82E, BX82E-VERS.122013, BX82G, BX82G-VERS.122013, FM1011E1, FM1011E2, FM1011E3, FM1011G1, FM1011G2, FM1011G3, FM1221E1, FM1221E2, FM1221E3, FM1221G1, FM1221G2, FM1221G3, FM611E2, FM611E3, FM611G1, FM611G2, FM611G3, FM721E1, FM721E2, FM721E3, FM721G1, FM721G2, FM721G3, FX101E1, FX101E1R, FX101E2, FX101E2C, FX101E2C-VERS.032014, FX101E2R, FX101E2R-VERS.032014, FX101E2-VERS.032014, FX101E3, FX101E3C, FX101E3C-VERS.022014...(Otros modelos se puede ver en la tienda web)		



1

código	359599	referencia	3019710 3030660
descripción	lámpara halógena casquillo G4 12V 20W resis.a la temp. 500°C		
Para modelos:	BX101E, BX101E-VERS.122013, BX101G, BX101G-VERS.122013, BX122E, BX122E-VERS.122013, BX122G, BX122G-VERS.122013, BX61E, BX61E-VERS.122013, BX61G, BX61G-VERS.122013, BX82E, BX82E-VERS.122013, BX82G, BX82G-VERS.122013, FM1011E1, FM1011E2, FM1011E3, FM1011G1, FM1011G2, FM1011G3, FM1221E1, FM1221E2, FM1221E3, FM1221G1, FM1221G2, FM1221G3, FM611E2, FM611E3, FM611G1, FM611G2, FM611G3, FM721E1, FM721E2, FM721E3, FM721G1, FM721G2, FM721G3, FPZ14E, FPZ16E, FPZ24E, FPZ26E, FPZ26E, FPZ24G, FPZ26G, FX101E1, FX101E1R, FX101E2, FX101E2C...(Otros modelos se puede ver en la tienda web)		

lámparas para neveras

PHILIPS



1

código	359595	referencia	32W3790
descripción	bombilla incandescente casquillo E14 15W 230-240V ø 25mm L 56mm cristal L 30mm UE 1 pzs		
Para modelos:	AF1B, AF1B-0PR01, AF1N, AF1N-0PR01, AF2B, AF2B-0PR01, AF2N, AF2N-0PR01, AGL6B, CX120, CX120B, CX120NN, CX130, CX130B, CX130NN, CX140, CX140B, CX140BN, CX140BR, CX140CP, CX140NN, CX140R, CX150, CX150B, CX150BN, CX150BR, CX150CP, CX150NN, CX150R, CX55, CX55B, CX60, CX60B, CX65, CX652, CX65B, CX65BR, CX65NB, CX65NCP, CX65NN, CX65R, CX70, CX702, CX70B, CX70BR, CX70NB, CX70NN, CX70R, FG2B, FSD1B...(Otros modelos se puede ver en la tienda web)		

lámparas para hornos

lámparas de horno universales

diámetro de montaje 35,5mm









1





código	357162	referencia	3008760
descripción	lámpara de horno montaje ø 35.5mm 12V 20W casquillo G4 resis.a la temp. 300°C empalme cable 450mm vidrio duro		
repuestos para	357162		
	código	359599	referencia 3019710 3030660
	lámpara halógena casquillo G4 12V 20W resis.a la temp. 500°C		
	código	359762	referencia —
	portalámparas casquillo G4 montaje ø 35.5mm empalme cable 450mm		
	código	359942	referencia —
	cubierta para lámpara de horno r.ø 33.5mm ø 41mm vidrio duro resis.a la temp. 350°C		



1



código	360759	referencia	3019720
descripción	lámpara de horno montaje ø 35.5mm 12V 20W casquillo G4 resis.a la temp. 350°C empalme cable 450mm vidrio duro		
Para modelos:	FPZ14E, FPZ16E, FPZ24E, FPZ2635E, FPZ26E, FPZ4G, FPZ6G		
repuestos para	360759		
	código	357192	referencia —
	lámpara halógena casquillo G4 12V 20W resis.a la temp.°C OSRAM HALOSTAR STARLITE		
	código	357264	referencia —
	portalámparas casquillo G4 montaje ø 35.5mm empalme cable 450mm		
	código	359033	referencia 3019730
	cubierta para lámpara de horno r.ø 33.5mm H 36mm ø 41mm vidrio duro resis.a la temp. 350°C		

			
código	359718	referencia	32W0740
descripción	lámpara de horno montaje ø 35.5mm 230V 15W casquillo E14 resis.a la temp. 300°C empalme conector Faston 6,3mm vidrio duro		
repuestos para	359718		
	código	359701	referencia 32W0746 32W2561
	portalámparas casquillo E14 220-230V montaje ø 35.5mm empalme conector Faston 6,3mm 15W		
	código	359740	referencia
	bombilla incandescente T máx 300°C casquillo E14 15W 230V ø 22mm L 48mm cristal L 20mm para lámpara de horno IMPORT		

			
código	359701	referencia	32W0746 32W2561
descripción	portalámparas casquillo E14 220-230V montaje ø 35.5mm empalme conector Faston 6,3mm 15W		
Para modelos:	FC101, FC101E, FC241, FC241E, FC241G, FC61, FC61E, FCV101, FCV101-CSA, FCV101DM, FCV101DM-CSA, FCV101DS, FCV101DS-CSA, FCV101E, FCV101EDM, FCV101EDM-UL, FCV101EDS, FCV101EDS-UL, FCV101E-UL, FCV141, FCV141-CSA, FCV141DM, FCV141DM-CSA, FCV141DS, FCV141DS-CSA, FCV141E, FCV141EDM, FCV141EDS, FCV241, FCV241DM, FCV241DS, FCV241E, FCV241EDM, FCV241EDM-UL, FCV241EDS, FCV241E-UL, FCV241G, FCV241GDM, FCV241GDM-CSA, FCV241GDS, FCV241GDS-CSA, FCV401DM, FCV401DM-CSA, FCV401EDM, FCV401EDM-UL, FCV61, FCV61-CSA, FCV61DM, FCV61DM-CSA, FCV61DS...(Otros modelos se puede ver en la tienda web)		
accesorios para	359701		
	código	359705	referencia 32W3080
	cubierta para lámpara de horno r.ø 33.5mm ø 52mm vidrio duro resis.a la temp. 350°C		
	código	359709	referencia
	cubierta para lámpara de horno r.ø 33.5mm ø 42mm vidrio duro resis.a la temp. 350°C		
	código	359721	referencia
	junta silicona ø ext. 48mm int.ø 39.5mm espesor 5mm UE 1 pzs		
	código	359942	referencia
	cubierta para lámpara de horno r.ø 33.5mm ø 41mm vidrio duro resis.a la temp. 350°C		

			
código	359033	referencia	3019730
descripción	cubierta para lámpara de horno r.ø 33.5mm H 36mm ø 41mm vidrio duro resis.a la temp. 350°C		
Para modelos:	FPZ14E, FPZ16E, FPZ24E, FPZ2635E, FPZ26E, FPZ4G, FPZ6G		

			
código	359705	referencia	32W3080
descripción	cubierta para lámpara de horno r.ø 33.5mm ø 52mm vidrio duro resis.a la temp. 350°C		
accesorios para	359705		
	código	359610	referencia 32W0780
	bombilla incandescente T máx 300°C casquillo E14 15W 230V ø 22mm L 47mm cristal L 20mm para lámpara de horno tipo Philips		
	código	359700	referencia
	junta para horno de pizza fibra de vidrio int.ø 32.5mm ø ext. 55mm espesor 5mm		
	código	359721	referencia
	junta silicona ø ext. 48mm int.ø 39.5mm espesor 5mm UE 1 pzs		
	código	359837	referencia
	junta int.ø 33mm ø ext. 46mm espesor 1mm grafito		
	código	359838	referencia
	junta int.ø 33mm ø ext. 45mm		

			
código	359661	referencia	32X3080
descripción	cubierta para lámpara de horno rosca 32.1 ø 58mm vidrio duro resis.a la temp. 350°C		
accesorios para	359661		
	código	359700	referencia
	junta para horno de pizza fibra de vidrio int.ø 32.5mm ø ext. 55mm espesor 5mm		

55x70mm			
			
código	359296	referencia	37M9910 37M9911
descripción	cristal de lámpara L 74mm An 58mm espesor 3mm		
Para modelos:	FCV3EM, FCV4E, FCV4EDS, FCV4EM		





			
1			
código	358147	referencia	3036970
descripción	junta L 75mm An 65mm espesor 1mm para lámpara de horno		
Para modelos:	FC1011E, FC1011G, FC1221E, FC1221G, FC611E, FC611G, FCV3EM, FCV4E, FCV4EDS, FCV4EM, FM1011E1, FM1011E1-VERS.2006, FM1011E2, FM1011E2-VERS.2006, FM1011E3, FM1011E3-VERS.2006, FM1011G1, FM1011G1-VERS.2006, FM1011G2, FM1011G2-VERS.2006, FM1011G3, FM1011G3-VERS.2006, FM1221E1, FM1221E1-VERS.2006, FM1221E2, FM1221E2-VERS.2006, FM1221E3, FM1221E3-VERS.2006, FM1221G1, FM1221G1-VERS.2006, FM1221G2, FM1221G2-VERS.2006, FM1221G3, FM1221G3-VERS.2006, FM2011E2-VERS.2006, FM2011E3-VERS.2006, FM2011G2-VERS.2006, FM2011G3-VERS.2006, FM2021E1, FM2021E2, FM2021E2-VERS.2006, FM2021E3-VERS.2006, FM2021G1, FM2021G2, FM2021G2-VERS.2006, FM2021G3, FM2021G3-VERS.2006, FM423E1, FM423E2, FM611E1...(Otros modelos se puede ver en la tienda web)		

			
1			
código	359299	referencia	37Q4100 37Q4106
descripción	junta L 91mm An 77mm agujero ø 3mm para lámpara de horno		
Para modelos:	FCV3EM, FCV4E, FCV4EDS, FCV4EM		

lámparas de horno específicas del fabricante

ANGELO PO

			
1			
código	359339	referencia	37Q7840
descripción	junta int.ø 65mm ø ext. 80mm espesor 1mm		
Para modelos:	FC101, FC101E, FC241, FC241E, FC241G, FC61, FC61E, FCV101, FCV101-CSA, FCV101DM, FCV101DM-CSA, FCV101DS, FCV101DS-CSA, FCV101E, FCV101EDM, FCV101EDM-UL, FCV101EDS, FCV101EDS-UL, FCV101E-UL, FCV141, FCV141-CSA, FCV141DM, FCV141DM-CSA, FCV141DS, FCV141DS-CSA, FCV141E, FCV141EDM, FCV141EDS, FCV241, FCV241DM, FCV241DS, FCV241E, FCV241EDM, FCV241EDM-UL, FCV241EDS, FCV241EDS-UL, FCV241E-UL, FCV241G, FCV241G-CSA, FCV241GDM, FCV241GDM-CSA, FCV241GDS, FCV241GDS-CSA, FCV401DM, FCV401DM-CSA, FCV401EDM, FCV401EDM-UL, FCV4E, FCV4EDS, FCV61...(Otros modelos se puede ver en la tienda web)		

			
1			
código	359701	referencia	32W0746 32W2561
descripción	portalámparas casquillo E14 220-230V montaje ø 35.5mm empalme conector Faston 6,3mm 15W		
Para modelos:	FC101, FC101E, FC241, FC241E, FC241G, FC61, FC61E, FCV101, FCV101-CSA, FCV101DM, FCV101DM-CSA, FCV101DS, FCV101DS-CSA, FCV101E, FCV101EDM, FCV101EDM-UL, FCV101EDS, FCV101EDS-UL, FCV101E-UL, FCV141, FCV141-CSA, FCV141DM, FCV141DM-CSA, FCV141DS, FCV141DS-CSA, FCV141E, FCV141EDM, FCV141EDS, FCV241, FCV241DM, FCV241DS, FCV241E, FCV241EDM, FCV241EDM-UL, FCV241EDS, FCV241E-UL, FCV241G, FCV241GDM, FCV241GDM-CSA, FCV241GDS, FCV241GDS-CSA, FCV401DM, FCV401DM-CSA, FCV401EDM, FCV401EDM-UL, FCV61, FCV61-CSA, FCV61DM, FCV61DM-CSA, FCV61DS...(Otros modelos se puede ver en la tienda web)		
accesorios para	359701		
		código	359705 referencia 32W3080
			cubierta para lámpara de horno r.ø 33.5mm ø 52mm vidrio duro resis.a la temp. 350°C
		código	359709 referencia —
			cubierta para lámpara de horno r.ø 33.5mm ø 42mm vidrio duro resis.a la temp. 350°C
		código	359721 referencia —
			junta silicona ø ext. 48mm int.ø 39.5mm espesor 5mm UE 1 pzs
		código	359942 referencia —
			cubierta para lámpara de horno r.ø 33.5mm ø 41mm vidrio duro resis.a la temp. 350°C



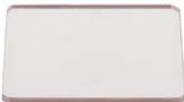

			
1			
código	359340	referencia	3036650 37M6210
descripción	vidrio redondo ø 78mm espesor 3mm		
Para modelos:	031FT04, 031FT06, 070FT04, 070FT05, 071FT04, 071FT06, 090FT04, 090FT05, 091FT04, 091FT06, 0A0FT1G, 0A0FT2G, 0A0FT4G, 0A0FT5G, 0D0FT1G, 0D0FT2G, 0D0FT4G, 0D0FT5G, 1A0FT1G, 1A0FT2G, 1A0FT3G, 1A0FT4G, 1A0FT6G, 1D0FT1G, 1D0FT2G, 1D0FT3G, 1D0FT4G, 1D0FT6G, FC101, FC101E, FC241, FC241E, FC241G, FC61, FC61E, FCV101, FCV101-CSA, FCV101DM, FCV101DM-CSA, FCV101DS, FCV101DS-CSA, FCV101E, FCV101EDM, FCV101EDM-UL, FCV101EDS, FCV101EDS-UL, FCV101E-UL, FCV141, FCV141-CSA, FCV141DM...(Otros modelos se puede ver en la tienda web)		







			
código	357180	referencia	3036960 3036961 3036962 3036963
descripción	cristal de lámpara L 73.6mm An 64mm espesor 4mm		
Para modelos:	BX101E, BX101E-VERS.122013, BX101G, BX101G-VERS.122013, BX122E, BX122E-VERS.122013, BX122G, BX122G-VERS.122013, BX61E, BX61E-VERS.122013, BX61G, BX61G-VERS.122013, BX82E, BX82E-VERS.122013, BX82G, BX82G-VERS.122013, FC1011E, FC1011G, FC1221E, FC1221G, FC611E, FC611G, FCV3EM, FCV4E, FCV4EDS, FCV4EM, FM1011E1, FM1011E1-VERS.2006, FM1011E2, FM1011E2-VERS.2006, FM1011E3, FM1011E3-VERS.2006, FM1011G1, FM1011G1-VERS.2006, FM1011G2, FM1011G2-VERS.2006, FM1011G3, FM1011G3-VERS.2006, FM1221E1, FM1221E1-VERS.2006, FM1221E2, FM1221E2-VERS.2006, FM1221E3, FM1221E3-VERS.2006, FM1221G1, FM1221G1-VERS.2006, FM1221G2, FM1221G2-VERS.2006, FM1221G3, FM1221G3-VERS.2006...(Otros modelos se puede ver en la tienda web)		

			
código	551336	referencia	36E3170
descripción	junta para lámpara L 92mm An 92mm espesor 2.3mm		
Para modelos:	BX101E, BX101E-VERS.122013, BX101G, BX101G-VERS.122013, BX122E, BX122E-VERS.122013, BX122G, BX122G-VERS.122013, BX61E, BX61E-VERS.122013, BX61G, BX61G-VERS.122013, BX82E, BX82E-VERS.122013, BX82G, BX82G-VERS.122013, FC1011E, FC1011G, FC1221E, FC1221G, FC611E, FC611G, FCV3EM, FCV4E, FCV4EDS, FCV4EM, FM1011E1, FM1011E1-VERS.2006, FM1011E2, FM1011E2-VERS.2006, FM1011E3, FM1011E3-VERS.2006, FM1011G1, FM1011G1-VERS.2006, FM1011G2, FM1011G2-VERS.2006, FM1011G3, FM1011G3-VERS.2006, FM1221E1, FM1221E1-VERS.2006, FM1221E2, FM1221E2-VERS.2006, FM1221E3, FM1221E3-VERS.2006, FM1221G1, FM1221G1-VERS.2006, FM1221G2, FM1221G2-VERS.2006, FM1221G3, FM1221G3-VERS.2006...(Otros modelos se puede ver en la tienda web)		

			
código	357179	referencia	3159800 3278370 35E3360
descripción	marco para lámpara de horno L 97mm An 97mm espesor 6mm distancia de sujeción 78mm ø 55mm		
Para modelos:	BX101E, BX101E-VERS.122013, BX101G, BX101G-VERS.122013, BX122E, BX122E-VERS.122013, BX122G, BX122G-VERS.122013, BX61E, BX61E-VERS.122013, BX61G, BX61G-VERS.122013, BX82E, BX82E-VERS.122013, BX82G, BX82G-VERS.122013, FC1011E, FC1011G, FC1221E, FC1221G, FC611E, FC611G, FCV3EM, FCV4E, FCV4EDS, FCV4EM, FM1011E1, FM1011E1-VERS.2006, FM1011E2, FM1011E2-VERS.2006, FM1011E3, FM1011E3-VERS.2006, FM1011G1, FM1011G1-VERS.2006, FM1011G2, FM1011G2-VERS.2006, FM1011G3, FM1011G3-VERS.2006, FM1221E1, FM1221E1-VERS.2006, FM1221E2, FM1221E2-VERS.2006, FM1221E3, FM1221E3-VERS.2006, FM1221G1, FM1221G1-VERS.2006, FM1221G2, FM1221G2-VERS.2006, FM1221G3, FM1221G3-VERS.2006...(Otros modelos se puede ver en la tienda web)		

			
código	357262	referencia	3097180
descripción	portalámparas casquillo E14 medida de montaje 55x70mm empalme conector Faston 6,3mm UE 1 pzs		
Para modelos:	FC1011E, FC1011G, FC1221E, FC1221G, FC611E, FC611G, FCV3EM, FCV4E, FCV4EDS, FCV4EM, FM423E1, FM423E2		
accesorios para	357262		
	código	357179	referencia
			3159800 3278370 35E3360
	marco para lámpara de horno L 97mm An 97mm espesor 6mm distancia de sujeción 78mm ø 55mm		
	código	357180	referencia
			3036960 3036961 3036962 3036963
	cristal de lámpara L 73.6mm An 64mm espesor 4mm		
	código	358147	referencia
			3036970
	junta L 75mm An 65mm espesor 1mm para lámpara de horno		
	código	551336	referencia
			36E3170
	junta para lámpara L 92mm An 92mm espesor 2.3mm		

			
código	359295	referencia	32V5570
descripción	portalámparas para lámpara halógena 12V 20W casquillo G4 medida de montaje 55 x 70mm longitud del cable 135mm		
Para modelos:	BX101E, BX101E-VERS.122013, BX101G, BX101G-VERS.122013, BX122E, BX122E-VERS.122013, BX122G, BX122G-VERS.122013, BX61E, BX61E-VERS.122013, BX61G, BX61G-VERS.122013, BX82E, BX82E-VERS.122013, BX82G, BX82G-VERS.122013, FM1011E1, FM1011E1-VERS.2006, FM1011E2, FM1011E2-VERS.2006, FM1011E3, FM1011E3-VERS.2006, FM1011G1, FM1011G1-VERS.2006, FM1011G2, FM1011G2-VERS.2006, FM1011G3, FM1011G3-VERS.2006, FM1221E1, FM1221E1-VERS.2006, FM1221E2, FM1221E2-VERS.2006, FM1221E3, FM1221E3-VERS.2006, FM1221G1, FM1221G1-VERS.2006, FM1221G2, FM1221G2-VERS.2006, FM1221G3, FM1221G3-VERS.2006, FM2011E2-VERS.2006, FM2011E3-VERS.2006, FM2011G2-VERS.2006, FM2011G3-VERS.2006, FM2021E1, FM2021E2, FM2021E2-VERS.2006, FM2021E3, FM2021E3-VERS.2006, FM2021G1...(Otros modelos se puede ver en la tienda web)		
repuestos para	359295		
	código	359599	referencia
			3019710 3030660
	lámpara halógena casquillo G4 12V 20W resis.a la temp. 500°C		
accesorios para	359295		
	código	359296	referencia
			37M9910 37M9911
	cristal de lámpara L 74mm An 58mm espesor 3mm		
	código	551336	referencia
			36E3170
	junta para lámpara L 92mm An 92mm espesor 2.3mm		



lámparas

bombillas incandescentes



código	359610	referencia	32W0780
descripción	bombilla incandescente T máx 300°C casquillo E14 15W 230V ø 22mm L 47mm cristal L 20mm para lámpara de horno tipo Philips		



código	359612	referencia	32W0210
descripción	bombilla incandescente T máx 300°C casquillo E14 25W 230V ø 25mm L 56mm cristal L 30mm para lámpara de horno tipo Philips		
Para modelos:	FC101, FC1011E, FC1011G, FC101E, FC1221E, FC1221G, FC241, FC241E, FC241G, FC61, FC611E, FC611G, FC61E, FCV101, FCV101-CSA, FCV101DM, FCV101DM-CSA, FCV101DS, FCV101DS-CSA, FCV101E, FCV101EDM, FCV101EDM-UL, FCV101EDS, FCV101EDS-UL, FCV101E-UL, FCV141, FCV141-CSA, FCV141DM, FCV141DM-CSA, FCV141DS, FCV141DS-CSA, FCV141E, FCV141EDM, FCV141EDS, FCV241, FCV241DM, FCV241DS, FCV241E, FCV241EDM, FCV241EDM-UL, FCV241EDS, FCV241EDS-UL, FCV241E-UL, FCV241G, FCV241G-CSA, FCV241GDM, FCV241GDM-CSA, FCV241GDS, FCV241GDS-CSA, FCV3EM...(Otros modelos se puede ver en la tienda web)		



código	359614	referencia	32W2350
descripción	bombilla incandescente T máx 300°C casquillo E27 230V 40W ø 45mm L 71mm cristal L 44mm UE 1 pzs		

lámparas halógenas

para portalámpara G4 / G6,35 / G9



código	357193	referencia	3030661
descripción	lámpara halógena casquillo G4 12V 20W resis.a la temp. 300°C OSRAM HALOSTAR OVEN		
Para modelos:	BX101E, BX101E-VERS.122013, BX101G, BX101G-VERS.122013, BX122E, BX122E-VERS.122013, BX122G, BX122G-VERS.122013, BX61E, BX61E-VERS.122013, BX61G, BX61G-VERS.122013, BX82E, BX82E-VERS.122013, BX82G, BX82G-VERS.122013, FM1011E1, FM1011E2, FM1011E3, FM1011G1, FM1011G2, FM1011G3, FM1221E1, FM1221E2, FM1221E3, FM1221G1, FM1221G2, FM1221G3, FM611E2, FM611E3, FM611G1, FM611G2, FM611G3, FM721E1, FM721E2, FM721E3, FM721G1, FM721G2, FM721G3, FX101E1, FX101E1R, FX101E2, FX101E2C, FX101E2C-VERS.032014, FX101E2R, FX101E2R-VERS.032014, FX101E2-VERS.032014, FX101E3, FX101E3C, FX101E3C-VERS.022014...(Otros modelos se puede ver en la tienda web)		

código	359599	referencia	3019710 3030660
descripción	lámpara halógena casquillo G4 12V 20W resis.a la temp. 500°C		
Para modelos:	BX101E, BX101E-VERS.122013, BX101G, BX101G-VERS.122013, BX122E, BX122E-VERS.122013, BX122G, BX122G-VERS.122013, BX61E, BX61E-VERS.122013, BX61G, BX61G-VERS.122013, BX82E, BX82E-VERS.122013, BX82G, BX82G-VERS.122013, FM1011E1, FM1011E2, FM1011E3, FM1011G1, FM1011G2, FM1011G3, FM1221E1, FM1221E2, FM1221E3, FM1221G1, FM1221G2, FM1221G3, FM611E2, FM611E3, FM611G1, FM611G2, FM611G3, FM721E1, FM721E2, FM721E3, FM721G1, FM721G2, FM721G3, FPZ14E, FPZ16E, FPZ24E, FPZ2635E, FPZ26E, FPZ4G, FPZ6G, FX101E1, FX101E1R, FX101E2, FX101E2C...(Otros modelos se puede ver en la tienda web)		

accesorios para lámparas

juntas



código	511436	referencia	37Q7370
descripción	junta para lámpara		
Para modelos:	135, 135-4, 135B, 135BN, 135BNX, 135BX, 135BXR, 135CPX, 135NN, 135NNX, 135X, 135X-3, 135X-4, 135XR, 65, 65B, 65BX, 65BX-2, 65BXR, 65NB, 65NBX, 65NN, 65NNX, 65X, 65X-2, 65XR, SP120, SP120B, SP120BN, SP120NN, SP135, SP135B, SP135BN, SP135CP, SP135NN, SP55, SP55B, SP65, SP65B, SP65NB, SP65NN		

temporizadores

temporizadores de programa



código	360380	referencia	32Z0391
descripción	temporizador BIGATTI motores 1 cámaras 1 tiempo de funcionamiento 3s aliment. 230V eje ø 6x4,6mm eje L 18mm N° fabricante 4023/3s. / 32Z0391 tipo de motor 82354039		



1

código	360382	referencia	32Z5730
descripción	temporizador BIGATTI motores 1 cámaras 1 tiempo de funcionamiento 6h aliment. 230V N° fabricante SA001 / 32Z5730 tipo de motor 82394530		



1

código	360196	referencia	32Z0780
descripción	temporizador CDC 4904F motores 1 cámaras 4 tiempo de funcionamiento 60s aliment. 230V N° fabricante 4904F3 / 3322060 tipo de motor M48L BTN		





1

código	360645	referencia	3289260
descripción	temporizador CDC 11901F motores 1 cámaras 1 tiempo de funcionamiento 20S aliment. 230V 50/60Hz eje ø 6x4mm eje L 25mm N° fabricante 11901F1CEE000.0000		
Para modelos:	FX201G3P, FX201G3-VERS.022014		





1

código	360215	referencia	32V1940
descripción	temporizador CDC 7805DV motores 2 cámaras 5 tiempo de funcionamiento 6s / 3min aliment. 230V eje ømm eje Lmm tipo de motor M37RN/M37LN		
Para modelos:	LC130, LC130-VERS.2001		
repuestos para	360215		
	código	360119	referencia —
	motor CDC piñón ø 5.4mm dientes 12 aliment. 230V sentido de rotación derecho ø motor 37mm tipo motor M37RN para temporizador		
	código	360131	referencia —
	motor CDC piñón ø 5.4mm dientes 12 aliment. 230V sentido de rotación izquierdo ø motor 37mm tipo motor M37LN para temporizador		





1

código	360389	referencia	32V7290
descripción	temporizador CDC 4904F motores 1 cámaras 4 tiempo de funcionamiento 5min aliment. 230V eje ømm eje Lmm N° fabricante 4904F3 / 10300122 tipo de motor M48L ATS		
Para modelos:	KD100, KD100A, KD100PSD, KD130, KD130A		
repuestos para	360389		
	código	360083	referencia —
	motor CDC piñón ø 4.9mm dientes 10 aliment. 230V sentido de rotación izquierdo ø motor 47mm H 19.3mm tipo motor M48L ATS para temporizador		



1

código	360379	referencia	32Z4760
descripción	temporizador CDC 9003F motores 1 cámaras 3 tiempo de funcionamiento 240s aliment. 230V eje ø 6x4,6mm eje L 20mm N° fabricante 9003F1 / 32Z4760 tipo de motor M48R ATS		
repuestos para	360379		
	código	360118	referencia —
	motor CDC piñón ø 4.9mm dientes 10 aliment. 230V tensión AC 50/60Hz sentido de rotación derecho ø motor 47mm H 19.3mm tipo motor M48R ATS para temporizador longitud del cable 260mm 1,9/2,5W		

1

código	360381	referencia	32Z5840
descripción	temporizador CDC motores 1 cámaras 2 tiempo de funcionamiento 2h aliment. 230V eje ø 6x4,6mm eje L 19mm N° fabricante 4900/32Z5840		



1

código	360386	referencia	32Z0310
descripción	temporizador CRONEL motores 1 cámaras 2 tiempo de funcionamiento 180s aliment. 230V eje ø 6x4,6mm eje L 18mm N° fabricante D9404 tipo de motor 82340		



1

código	360077	referencia	3030290
descripción	temporizador CROUZET motores 1 cámaras 2 tiempo de funcionamiento 120s aliment. 230V eje ømm eje Lmm N° fabricante 627/5261 tipo de motor 82340		



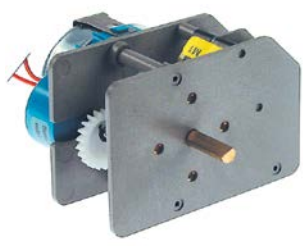

1

código	360289	referencia	3030290
descripción	temporizador CROUZET motores 1 cámaras 2 tiempo de funcionamiento 120s aliment. 230V eje ømm eje Lmm N° fabricante 627/5309 tipo de motor 600		
Para modelos:	KD37, KD40		



1

código	360334	referencia	32Z9630	
descripción	temporizador FIBER P04 motores 1 cámaras 2 tiempo de funcionamiento 120min aliment. 230V eje ø 6x4,6mm eje L 20mm N° fabricante P045J02W401 tipo de motor M51BJ0R6400 accionamiento eléctrico			
Para modelos:	FCV3EM, FCV4EM			
repuestos para	360334			
	código	360673	referencia	—
	kit de motor piñón ø 6.8mm dientes 15 aliment. 230V tensión AC 50/60Hz sentido de rotación en sentido horario ø motor 48mm H 18.5mm tipo motor UDS40NE1RNZ165 longitud del cable 150mm con soporte			





1

código	360436	referencia	32V5780
descripción	temporizador FIBER P24 motores 1 cámaras 1 tiempo de funcionamiento 20s aliment. 230V eje ø 4x6,4mm eje L 25mm N° fabricante P245J01C118 tipo de motor M51BJ0R0000		
Para modelos:	BX101E, BX101E-VERS.122013, BX101G, BX101G-VERS.122013, BX122E, BX122E-VERS.122013, BX122G, BX122G-VERS.122013, BX61E, BX61E-VERS.122013, BX61G, BX61G-VERS.122013, BX82E, BX82E-VERS.122013, BX82G, BX82G-VERS.122013, FM1011E1, FM1011E1-VERS.2006, FM1011E2, FM1011E2-VERS.2006, FM1011E3, FM1011E3-VERS.2006, FM1011G1, FM1011G1-VERS.2006, FM1011G2, FM1011G2-VERS.2006, FM1011G3, FM1011G3-VERS.2006, FM1221E1, FM1221E1-VERS.2006, FM1221E2, FM1221E2-VERS.2006, FM1221E3, FM1221E3-VERS.2006, FM1221G1, FM1221G1-VERS.2006, FM1221G2, FM1221G2-VERS.2006, FM1221G3, FM1221G3-VERS.2006, FM2011E2-VERS.2006, FM2011E3-VERS.2006, FM2011G2-VERS.2006, FM2011G3-VERS.2006, FM2021E1, FM2021E2, FM2021E2-VERS.2006, FM2021E3, FM2021E3-VERS.2006, FM2021G1...(Otros modelos se puede ver en la tienda web)		





1

código	360435	referencia	32V7300	
descripción	temporizador FIBER P25 motores 1 cámaras 4 tiempo de funcionamiento 6min aliment. 230V 50Hz eje ømm eje Lmm tipo de motor M51BJ0L6400			
repuestos para	360435			
	código	360674	referencia	—
	kit de motor piñón ø 6.8mm dientes 15 aliment. 230V tensión AC 50/60Hz sentido de rotación en sentido anti-horario ø motor 48mm H 18.5mm tipo motor UDS40NE1RNZ165 longitud del cable 150mm con soporte			





1

código	360234	referencia	32V2060
descripción	temporizador FIBER P25 motores 2 cámaras 4 tiempo de funcionamiento 6s / 3min aliment. 230V eje ømm eje Lmm N° fabricante P255J04JBC7 tipo de motor M51BJ0R6400 / M51BJ0L6400		
Para modelos:	LF50, LF50E, LF50EM		
repuestos para	360234		
	código	referencia	—
	360673	—	—
	kit de motor piñón ø 6.8mm dientes 15 aliment. 230V tensión AC 50/60Hz sentido de rotación en sentido horario ø motor 48mm H 18.5mm tipo motor UDS40NE1RNZ165 longitud del cable 150mm con soporte		
	código	referencia	—
	360674	—	—
	kit de motor piñón ø 6.8mm dientes 15 aliment. 230V tensión AC 50/60Hz sentido de rotación en sentido anti-horario ø motor 48mm H 18.5mm tipo motor UDS40NE1RNZ165 longitud del cable 150mm con soporte		





1

código	360232	referencia	32V0530
descripción	temporizador FIBER P25 motores 2 cámaras 5 tiempo de funcionamiento 6s / 9min aliment. 24V eje ømm eje Lmm N° fabricante P255205KEF0 tipo de motor M51B20R6400 / M51B20L6400 tensión AC		
repuestos para	360232		
	código	referencia	—
	360675	—	—
	kit de motor piñón ø 6.8mm dientes 15 aliment. 24V tensión AC 50/60Hz sentido de rotación en sentido horario ø motor 48mm H 18.5mm tipo motor UDS40NE1RNZ165 longitud del cable 150mm con soporte		
	código	referencia	—
	360676	—	—
	kit de motor piñón ø 6.8mm dientes 15 aliment. 24V tensión AC 50/60Hz sentido de rotación en sentido anti-horario ø motor 48mm H 18.5mm tipo motor UDS40NE1RNZ165 longitud del cable 150mm con soporte		



1

código	360245	referencia	32Z2020
descripción	temporizador FIBER P25 motores 2 cámaras 5 tiempo de funcionamiento 180s / 6min aliment. 230V eje ømm eje Lmm N° fabricante P255J05JZE6 tipo de motor M51BJ0R6400 / M51BJ0L6400		
Para modelos:	L40, L40S, L45, L60		
repuestos para	360245		
	código	referencia	—
	360673	—	—
	kit de motor piñón ø 6.8mm dientes 15 aliment. 230V tensión AC 50/60Hz sentido de rotación en sentido horario ø motor 48mm H 18.5mm tipo motor UDS40NE1RNZ165 longitud del cable 150mm con soporte		
	código	referencia	—
	360674	—	—
	kit de motor piñón ø 6.8mm dientes 15 aliment. 230V tensión AC 50/60Hz sentido de rotación en sentido anti-horario ø motor 48mm H 18.5mm tipo motor UDS40NE1RNZ165 longitud del cable 150mm con soporte		



1

código	360246	referencia	32Z8110
descripción	temporizador FIBER P25 motores 2 cámaras 5 tiempo de funcionamiento 80s / 5min aliment. 230V eje ømm eje Lmm N° fabricante P255J05KRH3 tipo de motor M51BJ0R6400 / M51BJ0L6400 tiempo de funcionamiento 80/300s		
Para modelos:	F80P, F80PR, L80		
repuestos para	360246		
	código	referencia	—
	360673	—	—
	kit de motor piñón ø 6.8mm dientes 15 aliment. 230V tensión AC 50/60Hz sentido de rotación en sentido horario ø motor 48mm H 18.5mm tipo motor UDS40NE1RNZ165 longitud del cable 150mm con soporte		
	código	referencia	—
	360674	—	—
	kit de motor piñón ø 6.8mm dientes 15 aliment. 230V tensión AC 50/60Hz sentido de rotación en sentido anti-horario ø motor 48mm H 18.5mm tipo motor UDS40NE1RNZ165 longitud del cable 150mm con soporte		



1

código	360392	referencia	3175700
descripción	temporizador FIBER P25 motores 2 cámaras 5 tiempo de funcionamiento 60s / 3min aliment. 230V eje ømm eje Lmm		



1

código	360051	referencia	32Z3840
descripción	temporizador FIBER P36 motores 1 cámaras 2 tiempo de funcionamiento 15min aliment. 230V eje ømm eje Lmm N° fabricante P365JR2J717 tipo de motor M51BJ0R6400		
Para modelos:	PGA20, PGA30, PGA40, PGA60, PGA80, PGW20, PGW30, PGW40, PGW60, PGW80		



1

código	360369	referencia	32Z5720
descripción	temporizador FIBER P37 motores 1 cámaras 3 tiempo de funcionamiento 120s aliment. 230V eje ømm eje Lmm N° fabricante P375J03H340 tipo de motor M51BJ0L***		
Para modelos:	LT10R, LT20F, LT25F		
repuestos para	360369		
	código	360674	referencia —
	kit de motor piñón ø 6.8mm dientes 15 aliment. 230V tensión AC 50/60Hz sentido de rotación en sentido anti-horario ø motor 48mm H 18.5mm tipo motor UDS40NE1RNZ165 longitud del cable 150mm con soporte		

temporizadores mecánicos



1

código	360447	referencia	32Z5540
descripción	reloj temporizador T203 1 polos tiempo de funcionamiento 5min accionamiento mecánico 1NO a 250 V 16(3)A posición permanente no eje ø 6x4,6mm eje 6x4,6mm eje L 16mm distancia de sujeción 30mm empalme atrás temperatura ambiente máx. 55°C		



1

código	350003	referencia	32Z0420 32Z2200
descripción	temporizador M2 con campana 2 polos tiempo de funcionamiento 120min accionamiento mecánico 2NO a 250 V 16A posición permanente no eje ø 6x4,6mm eje 6x4,6mm eje L 23mm distancia de sujeción 28mm empalme lateral		
Para modelos:	FC101, FC1011E, FC1011G, FC101E, FC1221E, FC1221G, FC241, FC241E, FC241G, FC61, FC611E, FC611G, FC61E		
accesorios para	350003		
	código	110366	referencia —
	pomo interruptor marca cero T máx°C ø 44mm eje ø 6x4,6mm parte plana arriba negro		
	código	111199	referencia —
	escala circular graduación 120min posición permanente no ángulo de rotación 0-330° ø 60mm relojes temporizador pomo ø 45mm		

temporizador de descongelación

BIGATTI



1

código	360058	referencia	32Z7100
descripción	reloj de descongelación tipo SB3.82 intervalo de descongelación 1-12x en 24h tiempo de descongelación 2-54min retardo ventilador 0-15min aliment. 230V func. descon. 1-12x cada 24h		
Para modelos:	40CP, 40CPX, 65NN, 65NNX, 6BMA11A, 6BMA11B, 6BMA11M, 6BMA2A, 6BMA2B, 6BMA2M, 6BMA3A, 6BMA3B, 6BMA3M, 6BMAA, 6BMAB, 6BMAM, 6BMB11A, 6BMB11B, 6BMB11M, 6BMB22A, 6BMB22B, 6BMB22M, 6BMB2A, 6BMB2B, 6BMB2M, 6BMB3A, 6BMB3B, 6BMB3M, 6BMB4A, 6BMB4B, 6BMB4M, 6BMB4A, 6BMBB, 6BMBM, 6BMC11A, 6BMC11B, 6BMC11M, 6BMC22A, 6BMC22B, 6BMC22M, 6BMC2A, 6BMC2B, 6BMC2M, 6BMC33A, 6BMC33B, 6BMC33M, 6BMC3A, 6BMC3B, 6BMC3M, 6BMC4A...(Otros modelos se puede ver en la tienda web)		

CDC



1

código	360384	referencia	32Z5731
descripción	reloj de descongelación CDC tipo 11901F intervalo de descongelación 4x en 24h retardo ventilador aliment. 230V		
Para modelos:	135A, 135XE, 65A, 65XE, S125, S125-4, S125E, S125X, S125X-4, S60, S60-2, S60E, S60X, S60X-2, SA87		



1

código	360521	referencia	32Z2420 32Z2421
descripción	reloj de descongelación CDC tipo 11901F intervalo de descongelación 4x en 24h tiempo de descongelación 12min retardo ventilador-min aliment. 230V 50-60Hz func. descon. cada 6 horas		
Para modelos:	120, 120NN, 120PV, 135, 135-4, 135BN, 135BNX, 135CPX, 135NN, 135NNX, 135PVX, 135X, 135X-3, 135X-4, 55, 55PV, 65, 65NN, 65NNX, 65PVX, 65X, 65X-2, SP65NN		

otros



1

código	360383	referencia	32Z2452
descripción	reloj de descongelación		

señalizadores de alarma

dispositivos de alarma



1

código	350056	referencia	32Z5860
descripción	señalizador de alarma 220-240VAC ømm H 25mm versión montaje mural distancia de sujeciónmm 83dB protección IPx0		
Para modelos:	FCV101, FCV101E, FCV141, FCV141E, FCV241, FCV241E, FCV241G, FCV241G-CSA, FCV3EM, FCV4EM, FCV61, FCV61E		

contactores

GENERAL ELECTRIC (AEG)

contactores de potencia



1

código	380262	referencia	3100910 32V7170 32Z2080 32Z2083
descripción	contactador de potencia AC1 32A 230VAC (AC3/400V) 17A/7,5kW contactos principales 3NO contactos auxiliares 1NC empalme empalme atornillado tipo AEG LS7K01A tipo GE CL02A 301 H 85mm		
Para modelos:	030FE, 030FE1, 030FE1B, 04WFR3ED, 08WFR4ED, 091FE28, 091FE28B, 091FR3E, 091FR3ED, 0A1FR3E, 0A1FR3ED, 0D1FR3E, 0D1FR3ED, 0G0FR3E, 0G0FR3ED, 191FR4E, 191FR4ED, 1A1FR4E, 1A1FR4ED, 1D1FR4E, 1D1FR4ED, 1G0FR4E, 1G1BR1E, 30FES, 30FES2, 30FES2B, 31RE, 6043840, 6043970, 70FES, 70FES2, 70FES2B, 71AR, 71ARE, 91AR, FC101, FC101E, FC241E, FC241G, FC61, FC611E, FC61E, FCV101, FCV101DM, FCV101DS, FCV101E, FCV101EDM, FCV101EDS, FCV141, FCV141DM...(Otros modelos se puede ver en la tienda web)		



1

código	380265	referencia	32Z2091
descripción	contactador de potencia AC1 60A 230VAC (AC3/400V) 32A/16kW contactos principales 3NO contactos auxiliares 1NO empalme empalme atornillado tipo AEG LS15K 00A tipo GE CL04A 310 H 98mm L 87mm An 55mm		
Para modelos:	04WCP1EM, 091CP1E, 091FR1E, 091FR1ED, 0A1FR1E, 0A1FR1ED, 0D1FR1E, 0D1FR1ED, 0G1BR3E, 191BR1E, 191BR2E, 191BR2EA, 191FR2E, 191FR2ED, 1A1BR1E, 1A1BR2E, 1A1BR2EA, 1A1FR2E, 1A1FR2ED, 1D1BR1E, 1D1BR2E, 1D1BR2EA, 1D1FR2ED, 1G1BR3E, 291BR1E, 291BR2E, 291BR2EA, 2A1BR1E, 2A1BR2E, 2A1BR2EA, 2D1BR1E, 2D1BR2E, 2D1BR2EA, 70FE1, 70FE1B, 71ARE, 71FE2, 71FE2B, 91ARE		



ISKRA (FANAL)

contactores de potencia



1

código	380415	referencia	32Z4471
descripción	contactor de potencia AC1 16A 230VAC (AC3/400V) 8,5A/5,5kW contactos principales 3NO contactos auxiliares 1NC empalme conector Faston 6,3mm tipo FANAL DSL7 01 tipo ISKRA K07MF 01		



1

código	380212	referencia	32V0980
descripción	contactor de potencia AC1 20A 230VAC (AC3/400V) 8,5A/5,5kW contactos principales 3NO contactos auxiliares 1NC empalme atornillado tipo FANAL K07M 01 tipo ISKRA DSL7 01		

LOVATO

contactores de potencia



1

código	380711	referencia	32Z3512 32Z4471
descripción	contactor de potencia AC1 20A 230VAC (AC3/400V) 9A/4kW contactos principales 3NO contactos auxiliares 1NC empalme conector Faston tipo 11BGF0901A230		
Para modelos:	070FTE, 070FTE, 071BME, 071FTE, 071FTE, 071FTE, 071FTE, 090FTE, 090FTE, 091BME, 091FTE, 091FTE, 091FTE, 71ARE, 91ARE, FC1011E, FC1221E, FC241E, FCV141E, FCV141EDM, FCV141EDS, FCV241E, FCV241EDM, FCV241EDS, FCV401EDM, FCV61E, FM1011E1, FM1011E1-VERS.2006, FM1011E2, FM1011E2-VERS.2006, FM1011E3, FM1011E3-VERS.2006, FM1221E1, FM1221E1-VERS.2006, FM1221E2, FM1221E2-VERS.2006, FM1221E3, FM1221E3-VERS.2006, FM2011E2-VERS.2006, FM2011E3-VERS.2006, FM2021E1, FM2021E2, FM2021E2-VERS.2006, FM2021E3, FM2021E3-VERS.2006, FM611E3, FM721E1, FM721E1-VERS.2006, FM721E2, FM721E2-VERS.2006, FM721E3... (Otros modelos se puede ver en la tienda web)		





1

código	380704	referencia	32V6550
descripción	contactor de potencia AC1 20A 230VAC (AC3/400V) 9A/4kW contactos principales 3NO contactos auxiliares 1NC empalme atornillado tipo 11BGF0901A230		
Para modelos:	08WGREV, 190GRE, 191BR2EA, 1A1BR2EA, 1D1BR2EA, 1G0GRE, 291BR1GA, 291BR2EA, 291BR2GA, 2A1BR1GA, 2A1BR2EA, 2A1BR2GA, 2D1BR1GA, 2D1BR2GA, FC1011E, FC1011G, FC1221E, FC1221G, FC611E, FC611G, FCV3EM, FM1011E3, FM1011E3-VERS.2006, FM1011G3, FM1011G3-VERS.2006, FM1221E3, FM1221E3-VERS.2006, FM1221G3, FM1221G3-VERS.2006, FM2021E3, FM2021G3, FM423E1, FM423E2, FM611E3, FM611E3-VERS.2006, FM611G3, FM611G3-VERS.2006, FM721E3, FM721E3-VERS.2006, FM721G3, FM721G3-VERS.2006, FX101E3, FX101E3C, FX101E3C-VERS.022014, FX101E3R, FX101E3R-VERS.022014, FX101E3-VERS.022014, FX101G3, FX101G3C, FX101G3C-VERS.022014...(Otros modelos se puede ver en la tienda web)		



1

código	380705	referencia	32V1880
descripción	contactor de potencia AC1 20A 230VAC (AC3/400V) 9A/4kW contactos principales 3NO contactos auxiliares 1NO empalme atornillado tipo 11BGF0910A230		
accesorios para	380705		
	código	380057	referencia —
	contacto auxiliar contactos 1NO/1NC AC1 10A para contactores serie BG empalme atornillado tipo BGX1011		



1

código	380083	referencia	3100940 32V5290
descripción	contactor de potencia AC1 25A 230VAC (AC3/400V) 9A/4,2kW contactos principales 3NO contactos auxiliares 1NC empalme atornillado tipo BF0901A230		
Para modelos:	04WBMEV, 06WFT1EV, 06WFT2EV, 06WFT3EV, 06WFT4EV, 06WFT6EV, 06WFT7EV, 08WFT1EV, 08WFT2EV, 08WFT3EV, 08WFT4EV, 08WFT6EV, 08WFT7EV, 091FT1E, 091FT2E, 091FT4E, 091FT5E, 091FT7E, 0G1CP1EC, 0G1FT2E, 0G1FT4E, 0G1FT5E, 0G1FT7E, 191FT1E, 191FT2E, 191FT3E, 191FT4E, 191FT6E, 191FT7E, 1G1FT2E, 1G1FT4E, 1G1FT5E, 1G1FT6E, 1G1FT7E, BX101E, BX101E-VERS.122013, BX101G, BX101G-VERS.122013, BX122E, BX122E-VERS.122013, BX122G, BX122G-VERS.122013, BX61E, BX61E-VERS.122013, BX61G, BX61G-VERS.122013, BX82E, BX82E-VERS.122013, BX82G, BX82G-VERS.122013...(Otros modelos se puede ver en la tienda web)		



1

código	380782	referencia	32Z2090
descripción	contactor de potencia AC1 40A 230VAC (AC3/400V) 12.5kW contactos principales 3NO empalme empalme atornillado		

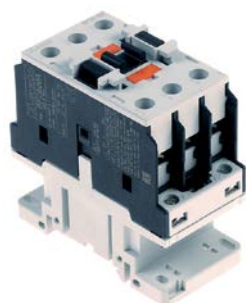

1

código	380721	referencia	3110890
descripción	contactor de potencia AC1 45A 230VAC (AC3/400V) 26A/13kW contactos principales 3NO contactos auxiliares empalme empalme atornillado tipo BF2600A230		
Para modelos:	091CP1E, 091FR1E, 091FR1EA, 091FR1ED, 091FR1EX, 0A1FR1E, 0A1FR1ED, 0D1FR1E, 0D1FR1ED, 191BR1E, 191BR2E, 191BR2EA, 191FR2E, 191FR2ED, 1A1FR2E, 1A1FR2ED, 1D1FR2ED, 291BR1E, 291BR2E, 291BR2EA, FX122E3, FX122E3C, FX122E3T, FX122E3T-VERS.022014, FX12E3CT, FX12E3CT-VERS.022014, FX201E3, FX201E3P, FX201E3P-VERS.022014, FX201E3-VERS.022014, FX202E3, FX202E3-VERS.022014		

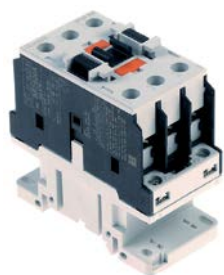

1

código	380722	referencia	3100930 32Z3511
descripción	contactor de potencia AC1 56A 230VAC (AC3/400V) 32A/16kW contactos principales 3NO contactos auxiliares empalme empalme atornillado tipo BF3200A230		
Para modelos:	091FR1ED, 10CP1EA, 12CP1EA, 18CP2EA, BRE21HD, BRE31HD, BX101E, BX101E-VERS.122013, BX122E, BX122E-VERS.122013, BX61E, BX61E-VERS.122013, BX82E, BX82E-VERS.122013, FC1011E, FC101E, FC1221E, FC241E, FCV101E, FCV101EDM, FCV101EDS, FCV141E, FCV141EDM, FCV141EDS, FCV241E, FCV241EDM, FCV241EDS, FCV401EDM, FCV61E, FM1011E1, FM1011E1-VERS.2006, FM1011E2, FM1011E2-VERS.2006, FM1011E3, FM1011E3-VERS.2006, FM1221E1, FM1221E1-VERS.2006, FM1221E2, FM1221E2-VERS.2006, FM1221E3, FM1221E3-VERS.2006, FM2011E2-VERS.2006, FM2011E3-VERS.2006, FM2021E1, FM2021E2, FM2021E2-VERS.2006, FM2021E3, FM2021E3-VERS.2006, FM611E3, FM721E1...(Otros modelos se puede ver en la tienda web)		

MOELLER/EATON

contactores de potencia



1

código	380171	referencia	32Z4840
descripción	contactor de potencia AC1 20A 230VAC (AC3/400V) 9A/4kW contactos principales 3NO contactos auxiliares 1NO empalme empalme atornillado tipo DILEM 10		
Para modelos:	LCV, P10, P102, P10M, P20, P202, P5, Q3, Q3M, Q5, Q52, Q5M, Q8, Q82, TV1, TV1M, TV2L		

SIEMENS

contactores de potencia



1

código	380646	referencia	32Z9250
descripción	contactor de potencia AC1 40A 230VAC (AC3/400V) 17A/7,5kW contactos principales 3NO contactos auxiliares empalme empalme atornillado tipo 3RT10-25-1AL20		
Para modelos:	ART1L7, ART1L7A, ART1L7M, ART1LD, ART1LD7, ART1LD7A, ART1LD7M, ART1LDA, ART2LD, ART2SD, ART3SD, B1101S, B151H, B151M, BF101L, BF101S, BF51H, BF51M, D12Q1M, D12Q2, D12Q2M, DS51, DS51A, DS51C, DS51M, FS611, GR135BT, GR140TN4, GR65BT, GR65TN4, IA101L, IA101S, IA51, IA51A, IA51C, IA51M, IA72S, IS101L, IS101LW, IS101S, IS101SR, IS101SW, IS102S, IS102SR-0NR01, IS102SW, IS51, IS51A, IS51AR, IS51C, IS51CR...(Otros modelos se puede ver en la tienda web)		

TELEMECANIQUE (Schneider Electric)

contactores de potencia



1

código	380617	referencia	32Z8680
descripción	contactor de potencia AC1 25A 24VAC (AC3/400V) 9A/4kW contactos principales 3NO contactos auxiliares 1NO/1NC empalme empalme atornillado tipo LC1D09B7		
Para modelos:	C165D, C165S, C165VD, C165VS, C207D, C207S, C207VD, C207VS, C304AD, C304AS, C304AVD, C304AVS, C304D, C304S, C304VD, C304VS, CS243D, CS243S, CS243VD, CS243VS, CS370AD, CS370AS, CS370AVD, CS370AVS, CS370D, CS370S, CS370VD, CS370VS, CS466AD, CS466AS, CS466AVD, CS466AVS, CS466D, CS466S, CS466VD, CS466VS, N303D, N303S, N303VD, N303VS, N354D, N354S, N354VD, N354VS, N506D, N506S, N506VD, N506VS, N607D, N607S... (Otros modelos se puede ver en la tienda web)		

relés

relés de potencia

con fijación atornillada



1

código	380817	referencia	32Z7930
descripción	relé de potencia Italiana Relè 230VAC 16A 2NO empalme conector Faston 6,3mm fijación atornillada N° fabricante B1-2-230AC		
Para modelos:	LT25F		

con lengüeta de sujeción



1

código	380815	referencia	32V0540
descripción	relé de potencia 230VAC 16A 2NO empalme conector Faston 6,3mm brida medidas 36x38x68mm		
Para modelos:	LC100, LC100-VERS.2001, LC130, LC130-VERS.2001, LC80, LF50, LF50E		

1			
código	380139	referencia	32V2950 32V7100 32Z2000
descripción	relé de potencia FINDER 230VAC 16A 2CO empalme F6,3 lengüeta de sujeción medidas 68x38,2x35,8mm N° fabricante 62.82.8.230.0000		
Para modelos:	F60P, F60PR, F60T, F80P, F80PR, KD100, KD100A, KD100PSD, KD37, KD40, KD85, KD85A, KD85PS, KD85PSA, KN35, KN37, KN37PS, KN40, KN40PS, KN40PSD, KN50, KN50M, KN50MPS, KN50PS, KN50PSD, KN50PSDD, KN80, KN80PS, L100, L40, L40S, L45, L60, L80, LC100, LC100-VERS.2001, LC130, LC130-VERS.2001, LC80, LP151		

1			
código	380403	referencia	32V2940
descripción	relé de potencia FINDER 230VAC 16A 3CO empalme F6,3 lengüeta de sujeción N° fabricante 62.83.8.230.0500		
Para modelos:	LF50EM, LP124, LP124V, LP84V		

1			
código	380185	referencia	32V3720
descripción	relé de potencia Italiana Relè 230VAC 30A 1NO empalme F6,3 lengüeta de sujeción medidas 36,5x32,2x51,8mm N° fabricante A10-230AC-FA		



relés enchufables/para circuito impreso

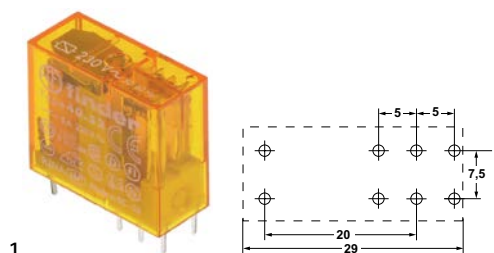

código	380333	referencia	32V6630
descripción	relé para circuito impreso 230VAC 2CO a 250 V 8A empalme pins medida reticular 5mm FINDER N° fabricante 40.52.8.230.0000 95.65/95.75		
Para modelos:	191BR2EA, FM1221G1, FM1221G2, FM1221G3, FM2011G2-VERS.2006, FM2011G3-VERS.2006, FM2021G1, FM2021G2, FM2021G2-VERS.2006, FM2021G3, FM2021G3-VERS.2006		
accesorios para	380333		
	código	380340	referencia —
	zócalo de relé medidas 62x36x15mm 250V tensión AC 10A Italiana Relé N° fabricante ZMEM/5		
	código	380505	referencia —
	zócalo de relé 2CO 40.52 medidas 81,9x15,5x75mm 250V tensión AC 10A FINDER N° fabricante 95.95.3		
	código	381181	referencia —
	zócalo de relé 2 polos 40.51/40.52/40.61 empalme borne roscado medidas 15,8x78,6mm 250V tensión AC 10A FINDER N° fabricante 95.75		

con clavija



código	400956	referencia	32V5770
descripción	transformador primaria 230VAC secundaria 12VAC 20VA empalme conector Faston 6,3mm 50/60Hz tipo T602012/E limitación de temperatura 150°C temperatura ambiente máx. 80°C		
Para modelos:	B1101S, B151H, B151M, BF101L, BF101S, BF51H, BF51M, BX101E, BX101E-VERS.122013, BX101G, BX101G-VERS.122013, BX61E, BX61E-VERS.122013, BX61G, BX61G-VERS.122013, BX82E, BX82E-VERS.122013, BX82G, BX82G-VERS.122013, FM1011E1, FM1011E1-VERS.2006, FM1011E2, FM1011E2-VERS.2006, FM1011E3, FM1011E3-VERS.2006, FM1011G1, FM1011G1-VERS.2006, FM1011G2, FM1011G2-VERS.2006, FM1011G3, FM1011G3-VERS.2006, FM611E1, FM611E1-VERS.2006, FM611E2, FM611E2-VERS.2006, FM611E3, FM611E3-VERS.2006, FM611G1, FM611G1-VERS.2006, FM611G2, FM611G2-VERS.2006, FM611G3, FM611G3-VERS.2006, FM721E1, FM721E1-VERS.2006, FM721E2, FM721E2-VERS.2006, FM721E3, FM721E3-VERS.2006, FM721G1...(Otros modelos se puede ver en la tienda web)		

transformadores encapsulados

PMA



código	379054	referencia	32Z3470
descripción	transformador primaria 230VAC secundaria 12VAC 3VA secundaria 0.25A H 40mm L 45mm An 50mm empalme atornillado 50/60Hz tipo 153/M		
Para modelos:	120, 120B, 120PV, 135, 135-4, 135B, 135BA, 135BN, 135BNX, 135BX, 135BXE, 135BXR, 135CPX, 135PVX, 135X, 135X-3, 135X-4, 135XR, 40CP, 40CPX, 55, 55B, 55PV, 65, 65B, 65BA, 65BX, 65BX-2, 65BXE, 65BXR, 65NB, 65NBX, 65PVX, 65X, 65X-2, 65XR, 6BMA11A, 6BMA11B, 6BMA11M, 6BMA11Z, 6BMA2A, 6BMA2B, 6BMA2M, 6BMA2Z, 6BMA3A, 6BMA3B, 6BMA3M, 6BMA3Z, 6BMAA, 6BMAB...(Otros modelos se puede ver en la tienda web)		

transformadores

transformadores abiertos

con borne de empalme



código	403905	referencia	3117170
descripción	transformador primaria 230V/50-60Hz secundaria 12V 50VA empalme empalme atornillado tipo T1ULF		
Para modelos:	10CP1EA, 10CP1GA, 10CP1IA, 12CP1EA, 12CP1GA, 12CP1IA, 18CP2EA, 18CP2GA, 18CP2IA, FX101E1, FX101E1R, FX101E2, FX101E2C, FX101E2C-VERS.032014, FX101E2R, FX101E2R-VERS.032014, FX101E2-VERS.032014, FX101E3, FX101E3C, FX101E3C-VERS.022014, FX101E3R, FX101E3R-VERS.022014, FX101E3-VERS.022014, FX101G1, FX101G1R, FX101G2, FX101G2C, FX101G2C-VERS.032014, FX101G2R, FX101G2R-VERS.032014, FX101G2-VERS.032014, FX101G3, FX101G3C, FX101G3C-VERS.022014, FX101G3R, FX101G3R-VERS.022014, FX101G3-VERS.022014, FX10E2CR, FX10E2CR-VERS.032014, FX10E3CR, FX10E3CR-VERS.022014, FX10G2CR, FX10G2CR-VERS.032014, FX10G3CR, FX10G3CR-VERS.022014, FX122E1, FX122E2, FX122E2C, FX122E2T, FX122E2T-VERS.032014...(Otros modelos se puede ver en la tienda web)		



controladores electrónicos

ELIWELL

controladores de punto de refrigeración

versión empotrada



1

código	379114	referencia	32Z3460
descripción	controlador electrónico ELIWELL tipo EWPC961 medida de montaje 71x29mm		



1

código	379102	referencia	32Z3660
descripción	controlador electrónico ELIWELL tipo EWPC970 medida de montaje 71x29mm aliment. 12V salidas de relé 8A		



1

código	379614	referencia	32V7580
descripción	controlador electrónico ELIWELL tipo ID961 medida de montaje 71x29mm aliment. 230V tensión AC NTC/PTC dimensiones frontales 33x75mm protección IP65 incl. 1x sensor NTC -50 a +150°C display 3½ cifras LCD 1999 Dígitos		
Para modelos:	MX120, MX130, MX130NN, MX140, MX150, MX150NN, MX60, MX70		
accesorios para	379614		
	código	referencia	32V6000
	sensor de temperatura NTC 10kOhm cable PVC sonda -20 a +80°C cable -10 a 100°C bulbo ø7x24,5mm longitud de cable 1.5m sin racor de dos hilos		
	código	referencia	—
	sensor de temperatura PTC 1kOhm cable silicona sonda -50 a +150°C cable -50 a +180°C bulbo ø6x40mm longitud de cable 1.5m sin racor de dos hilos		
	código	referencia	—
	sensor de temperatura PTC 1kOhm cable PVC sonda -50 a +150°C cable -10 a 100°C bulbo ø6x30mm longitud de cable 3m sin racor de dos hilos		
	código	referencia	—
	sensor de temperatura NTC 10kOhm cable PVC sonda -20 a +80°C cable -10 a 100°C bulbo ø6x25mm longitud de cable 3m de dos hilos		
	código	referencia	8223470
	sensor de temperatura PTC 1kOhm cable silicona sonda -50 a +150°C cable -50 a +180°C bulbo ø6x40mm longitud de cable 3m sin racor de dos hilos		

accesorios para	379614		
	código	referencia	—
	sensor de temperatura PTC 1kOhm cable PVC sonda -50 a +150°C cable -10 a 100°C bulbo ø6x30mm longitud de cable 1.5m sin racor de dos hilos		
	código	referencia	—
	sensor de temperatura NTC 10kOhm cable termoplástico sonda -40 a +110°C cable -40 a +110°C bulbo ø6x14mm longitud de cable 1.5m sin racor de dos hilos		
	código	referencia	32V6010
	sensor de temperatura NTC 10kOhm cable termoplástico sonda -40 a +110°C cable -40 a +110°C bulbo ø6x14mm longitud de cable 3m sin racor de dos hilos		
	código	referencia	32V3730
	sensor de temperatura NTC 10kOhm cable silicona sonda -40 a +110°C cable -50 a +180°C bulbo ø6x40mm longitud de cable 3m de dos hilos		
	código	referencia	—
	sensor de temperatura NTC 10kOhm cable silicona sonda -40 a +110°C cable -50 a +180°C bulbo ø6x40mm longitud de cable 1.5m sin racor de dos hilos		
	código	referencia	—
	sensor de temperatura PTC 1kOhm cable termoplástico sonda -50 a +150°C cable -40 a +110°C bulbo ø6x14mm longitud de cable 1.5m sin racor de dos hilos		
	código	referencia	—
	sensor de temperatura PTC 1kOhm cable termoplástico sonda -50 a +150°C cable -40 a +110°C bulbo ø6x14mm longitud de cable 3m de dos hilos resistencia 1kOhm		

EVCO - EVERY CONTROL

controladores universales

versión empotrada



1

código	379632	referencia	32V0421
descripción	controlador electrónico EVERY CONTROL medida de montaje 135x66mm profundidad de montaje 67mm aliment. 230V tensión AC con accesorios -50 a +100°C tipo ECS805P220D306 dimensiones frontales 142x70mm		
Para modelos:	ART2LD, ART2SD, ART3SD		



1

código	379616	referencia	32V5020
descripción	controlador electrónico EVERY CONTROL medida de montaje 71x29mm aliment. 12V tensión AC TC-K protección IP65 0-999°C tipo FK400A dimensiones frontales 33x75mm		
Para modelos:	FPZ4G, FPZ6G		

**controladores de punto de refrigeración****versión empotrada**

1			
código	379232	referencia	32V6500
descripción	controlador electrónico		
Para modelos:	CX70R		



1			
código	379609	referencia	32V6060
descripción	controlador electrónico ANGELO PO medida de montaje 71x29mm aliment. 12V tensión AC NTC salidas de relé 1 relé dimensiones frontales 33x75mm protección IP65 incl. 2xsensor NTC -40 a +99°C relé compresor 16A		
Para modelos:	CX130B, CX60B, FX150B, FX70B, MX120B, MX140B, MX55B, MX65B, S1200B, S1200B4, S1200BE, S600B, S600B2, S600BE		



1			
código	381388	referencia	32V2090
descripción	controlador electrónico ANGELO PO kit de modificación medida de montaje 71x29mm aliment. 230V tensión AC NTC dimensiones frontales 33x75mm protección IP65 incl. 1x sensor NTC -40 a +99°C		
Para modelos:	6SMA, 6SMA2, 6SMA2A, 6SMA2B, 6SMA2M, 6SMA2Z, 6SMA4Z, 6SMAA, 6SMAAB, 6SMAAM, 6SMAZ, 6SMB, 6SMB2, 6SMB2A, 6SMB2B, 6SMB2M, 6SMB2Z, 6SMB4, 6SMB4A, 6SMB4B, 6SMB4M, 6SMB4Z, 6SMB6Z, 6SMB6, 6SMBB, 6SMBM, 6SMBZ, 6SMC, 6SMC2, 6SMC2A, 6SMC2B, 6SMC2M, 6SMC2Z, 6SMC4, 6SMC4A, 6SMC4B, 6SMC4M, 6SMC4Z, 6SMC6, 6SMC6A, 6SMC6B, 6SMC6M, 6SMC6Z, 6SMC8Z, 6SMCA, 6SMCB, 6SMCM, 6SMCZ, PE1633, PE1633V...(Otros modelos se puede ver en la tienda web)		



1			
código	379608	referencia	32V6080
descripción	controlador electrónico EVERY CONTROL medida de montaje 71x29mm aliment. 12V tensión AC NTC salidas de relé 1 relé dimensiones frontales 33x75mm protección IP65 incl. 2xsensor NTC -40 a +99°C relé compresor 16A		
Para modelos:	CX130B, CX150B, CX150BN, CX150BR, CX60B, CX70B, CX70BR		





1			
código	379613	referencia	32V2980
descripción	controlador electrónico ANGELO PO medida de montaje 71x29mm aliment. 12V tensión AC NTC dimensiones frontales 33x75mm protección IP65 incl. 2xsensor NTC -40 a +110°C		
Para modelos:	135B, 135BN, 135BNX, 135BX, 135BXR, 65B, 65BX, 65BX-2, 65BXR, 65NB, 65NBX, SP65NB		



1			
código	378187	referencia	32V6050
descripción	controlador electrónico EVERY CONTROL medida de montaje 71x29mm aliment. 230V tensión AC NTC/PTC salidas de relé 1 1CO -50 a +150°C display 3½ dígitos		
Para modelos:	CX130, CX130NN, CX60, FX150, FX150NN, FX70		



			
1			
código	378192	referencia	32V6900
descripción	controlador electrónico EVERY CONTROL tipo EVK201 medida de montaje 71x29mm aliment. 230V tensión AC NTC salidas de relé 1 relé 1CO NTC func. descon. no -50 a +150°C display 3½ dígitos relé compresor 10A		
Para modelos:	6SMA, 6SMA2, 6SMA2A, 6SMA2B, 6SMA2M, 6SMA2Z, 6SMA4Z, 6SMAA, 6SMAB, 6SMAM, 6SMAZ, 6SMB, 6SMB2, 6SMB2A, 6SMB2B, 6SMB2M, 6SMB2Z, 6SMB4, 6SMB4A, 6SMB4B, 6SMB4M, 6SMB4Z, 6SMB6Z, 6SMB6A, 6SMB6B, 6SMB6M, 6SMB6Z, 6SMC, 6SMC2, 6SMC2A, 6SMC2B, 6SMC2M, 6SMC2Z, 6SMC4, 6SMC4A, 6SMC4B, 6SMC4M, 6SMC4Z, 6SMC6, 6SMC6A, 6SMC6B, 6SMC6M, 6SMC6Z, 6SMC8Z, 6SMCA, 6SMCB, 6SMCM, 6SMCZ, PE1633, PE1633V...(Otros modelos se puede ver en la tienda web)		

			
1			
código	378126	referencia	3087950 3107290 3120900 32V6920 32V7490 32V7820 32V8590
descripción	controlador electrónico EVERY CONTROL tipo EVK201N7 medida de montaje 71x29mm aliment. 230V tensión AC NTC/PTC salidas de relé 1 CO-16A(5) NTC/PTC dimensiones frontales 33x75mm profundidad de montaje 59mm protección IP65 -40 a +105°C display 3½ dígitos		
Para modelos:	3G6SA, 3G6SA2, 3G6SA4, 4G6SB, 4G6SB2, 4G6SB4, 4G6SB6, 6BR15V, 6BR15VC, 6BR19V, 6BR19VC, 6MA, 6MA2, 6MA2A, 6MA2M, 6MAA, 6MAM, 6MB, 6MB11, 6MB11A, 6MB11M, 6MB2, 6MB2A, 6MB2M, 6MB4, 6MB4A, 6MB4M, 6MBA, 6MBM, 6MC, 6MC11, 6MC11A, 6MC11M, 6MC2, 6MC2A, 6MC2M, 6MC4, 6MC4A, 6MC4M, 6MCA, 6MCM, 6MJA, 6MJA2, 6MJA2A, 6MJA2M, 6MJAA, 6MJAM, 6MJB, 6MJB2, 6MJB2A...(Otros modelos se puede ver en la tienda web)		
accesorios para	378126		
	código	379053	referencia —
	sensor de temperatura PTC 1kOhm cable PVC sonda -50 a +150°C cable -10 a 100°C bulbo ø6x30mm longitud de cable 3m sin racor de dos hilos		
	código	379064	referencia 8223470
	sensor de temperatura PTC 1kOhm cable silicona sonda -50 a +150°C cable -50 a +180°C bulbo ø6x40mm longitud de cable 3m sin racor de dos hilos		
	código	379161	referencia 32V6010
	sensor de temperatura NTC 10kOhm cable termoplástico sonda -40 a +110°C cable -40 a +110°C bulbo ø6x14mm longitud de cable 3m sin racor de dos hilos		
	código	379782	referencia —
	sensor de temperatura PTC 1kOhm cable termoplástico sonda -50 a +150°C cable -40 a +110°C bulbo ø6x14mm longitud de cable 3m de dos hilos resistencia 1kOhm		

			
1			
código	378154	referencia	3048060 3096600 3106300 3107300 3119780
descripción	controlador electrónico EVERY CONTROL tipo EVK203N7VXB5 medida de montaje 71x29mm aliment. 230V tensión AC NTC/PTC salidas de relé 3 NO-16A(5) CO-8A(4) NO-8A(4) NTC/PTC NTC/PTC DI dimensiones frontalesmm profundidad de montaje 59mm protección IP65 presente -50 a +150°C display 3½ dígitos		
Para modelos:	6ERA-OPR01, 6ERA2-OPR01, 6ERA2A-OPR01, 6ERA2M-OPR01, 6ERAA-OPR01, 6ERAM-OPR01, 6ERB-OPR01, 6ERB2-OPR01, 6ERB2A-OPR01, 6ERB2M-OPR01, 6ERB4-OPR01, 6ERB4A-OPR01, 6ERB4M-OPR01, 6ERBA-OPR01, 6ERBM-OPR01, 6ERC-OPR01, 6ERC2-OPR01, 6ERC2A-OPR01, 6ERC2M-OPR01, 6ERC4-OPR01, 6ERC4A-OPR01, 6ERC4M-OPR01, 6ERCA-OPR01, 6ERCM-OPR01, BS11, BS11A, BS11M, BS16, BS16A, BS16M, BS21, BS21A, BS21M, BSR11, BSR11A, BSR11M, BSR16, BSR16A, BSR16M, BSR21, BSR21A, BSR21M, MD130, MD130BN, MD130NN, MD150, MD150A, MD150BN, MD150NCP, MD150NN...(Otros modelos se puede ver en la tienda web)		
accesorios para	378154		
	código	379053	referencia —
	sensor de temperatura PTC 1kOhm cable PVC sonda -50 a +150°C cable -10 a 100°C bulbo ø6x30mm longitud de cable 3m sin racor de dos hilos		
	código	379064	referencia 8223470
	sensor de temperatura PTC 1kOhm cable silicona sonda -50 a +150°C cable -50 a +180°C bulbo ø6x40mm longitud de cable 3m sin racor de dos hilos		
	código	379161	referencia 32V6010
	sensor de temperatura NTC 10kOhm cable termoplástico sonda -40 a +110°C cable -40 a +110°C bulbo ø6x14mm longitud de cable 3m sin racor de dos hilos		
	código	379782	referencia —
	sensor de temperatura PTC 1kOhm cable termoplástico sonda -50 a +150°C cable -40 a +110°C bulbo ø6x14mm longitud de cable 3m de dos hilos resistencia 1kOhm		

			
1			
código	378189	referencia	32V6290 32V6300
descripción	controlador electrónico EVERY CONTROL tipo EVK213 medida de montaje 71x29mm aliment. 12V tensión AC/DC NTC/PTC salidas de relé 3 relés -40 a +105°C display 3½ dígitos DEF Relay 8A relé ventilador 8A relé compresor 16A		
Para modelos:	CX150CP, CX70NB		



1

código	378188	referencia	32V6070 32V6270
descripción	controlador electrónico EVERY CONTROL tipo FK203B medida de montaje 71x29mm aliment. 12V tensión AC/DC NTC salidas de relé 3 relés -40 a +99°C DEF Relay 8A relé ventilador 8A relé compresor 10A		
Para modelos:	CX130, CX130NN, CX150, CX150BN, CX150CP, CX150NN, CX150PV, CX150R, CX60, CX70, CX702, CX70PV		



1

código	378190	referencia	32V6280
descripción	controlador electrónico EVERY CONTROL tipo FK203B medida de montaje 71x29mm aliment. 12V tensión AC/DC NTC salidas de relé 3 relés -40 a +99°C DEF Relay 8A relé ventilador 8A relé compresor 10A		
Para modelos:	CX70NB, CX70NN		



1

código	378191	referencia	32V6260
descripción	controlador electrónico EVERY CONTROL tipo FK203B medida de montaje 71x29mm aliment. 12V tensión AC/DC NTC salidas de relé 3 relés -40 a +99°C DEF Relay 8A relé ventilador 8A relé compresor 10A		



1

código	378193	referencia	32V2920
descripción	controlador electrónico EVERY CONTROL tipo FK206A medida de montaje 71x29mm aliment. 12V tensión AC/DC NTC -40 a +99°C		
Para modelos:	6JA, 6JA2, 6JA2A, 6JA2M, 6JAA, 6JAM, 6JB, 6JB2, 6JB2A, 6JB2M, 6JB4A, 6JB4M, 6JBA, 6JBM		



1

código	379615	referencia	32V7490
descripción	controlador electrónico medida de montaje 71x29mm aliment. 230V tensión AC NTC salidas de relé 1 relé dimensiones frontales 33x75mm protección IP65 incl. 1x sensor NTC -40 a +99°C relé compresor 16A		
Para modelos:	40, 40-OPR01, 40PV, 40PV-OPR01, 40X, 40X-OPR01, 40XPV		

termómetros electrónicos

versión empotrada



1

código	379900	referencia	32Z8250
descripción	termómetro EVERY CONTROL tipo TM103T N4 medida de montaje 58x25,5mm 24V tensión AC -40 a +110°C entrada de medición NTC display 2½ dígitos dimensiones frontales 31x64mm protección IP54 precisión 1%		
Para modelos:	C165D, C165S, C165VD, C165VS, C207D, C207D-VERS.2006, C207S, C207S-VERS.2006, C207VD, C207VD-VERS.2006, C207VS, C207VS-VERS.2006, C304AD, C304AD-VERS.2006, C304AS, C304AS-VERS.2006, C304AVD, C304AVD-VERS.2006, C304AVS, C304AVS-VERS.2006, C304D, C304D-VERS.2006, C304S, C304S-VERS.2006, C304VD, C304VD-VERS.2006, C304VS, C304VS-VERS.2006, C92D-VERS.2006, C92S-VERS.2006, C92VD-VERS.2006, C92VS-VERS.2006, CS243D, CS243D-VERS.2006, CS243S, CS243S-VERS.2006, CS243VD, CS243VD-VERS.2006, CS243VS, CS243VS-VERS.2006, CS370AD, CS370AD-VERS.2006, CS370AS, CS370AS-VERS.2006, CS370AVD, CS370AVD-VERS.2006, CS370AVS, CS370AVS-VERS.2006, CS370D, CS370D-VERS.2006...(Otros modelos se puede ver en la tienda web)		



accesorios



código	378197	referencia	32V7460
descripción	impresora EVERY CONTROL PM100AX9S201 medida de montaje 90x90mm		
Para modelos:	ISP202R, ISR201R, ISR202R, SM145R, SM75R		

SHANGFANG

accesorios



código	379054	referencia	32Z3470
descripción	transformador primaria 230VAC secundaria 12VAC 3VA secundaria 0.25A H 40mm L 45mm An 50mm empalme atornillado 50/60Hz tipo 153/M		
Para modelos:	120, 120B, 120PV, 135, 135-4, 135B, 135BA, 135BN, 135BNX, 135BX, 135BXE, 135BXR, 135CPX, 135PVX, 135X, 135X-3, 135X-4, 135XR, 40CP, 40CPX, 55, 55B, 55PV, 65, 65B, 65BA, 65BX, 65BX-2, 65BXE, 65BXR, 65NB, 65NBX, 65PVX, 65X, 65X-2, 65XR, 6BMA11A, 6BMA11B, 6BMA11M, 6BMA11Z, 6BMA2A, 6BMA2B, 6BMA2M, 6BMA2Z, 6BMA3A, 6BMA3B, 6BMA3M, 6BMA3Z, 6BMAA, 6BMAB...(Otros modelos se puede ver en la tienda web)		

sensores

sensores universales

sondas de temperatura

código	378194	referencia	32V6000
descripción	sensor de temperatura NTC 10kOhm cable PVC sonda -20 a +80°C cable -10 a 100°C bulbo ø7x24,5mm longitud de cable 1.5m sin racor de dos hilos		
Para modelos:	6MA, 6MA2, 6MA2A, 6MA2M, 6MAA, 6MAM, 6MB, 6MB11, 6MB11A, 6MB11M, 6MB2, 6MB2A, 6MB2M, 6MB4, 6MB4A, 6MB4M, 6MBA, 6MBM, 6MC, 6MC11, 6MC11A, 6MC11M, 6MC2, 6MC2A, 6MC2M, 6MC4, 6MC4A, 6MC4M, 6MCA, 6MCM, 6MJA, 6MJA2, 6MJA2A, 6MJA2M, 6MJAA, 6MJAM, 6MJB, 6MJB2, 6MJB2A, 6MJB2M, 6MJB4, 6MJB4A, 6MJB4M, 6MJBA, 6MJBM, BP41P, BP41X, BP53G, BP53V, BP53X...(Otros modelos se puede ver en la tienda web)		

código	379343	referencia	32V3730
descripción	sensor de temperatura NTC 10kOhm cable silicona sonda -40 a +110°C cable -50 a +180°C bulbo ø6x40mm longitud de cable 3m de dos hilos		
Para modelos:	6EA, 6EA11, 6EA11A, 6EA11M, 6EA13, 6EA13A, 6EA13M, 6EA2, 6EA2A, 6EA2M, 6EAA, 6EAB, 6EABA, 6EABM, 6EAM, 6EB, 6EB11, 6EB11A, 6EB11M, 6EB13, 6EB13A, 6EB13M, 6EB2, 6EB22, 6EB22A, 6EB22M, 6EB2A, 6EB2M, 6EB4, 6EB4A, 6EB4M, 6EBA, 6EBB, 6EBBA, 6EBBM, 6EBM, 6EC, 6EC11, 6EC11A, 6EC11M, 6EC13, 6EC13A, 6EC13M, 6EC2, 6EC22, 6EC22A, 6EC22M, 6EC2A, 6EC2M, 6EC4...(Otros modelos se puede ver en la tienda web)		

código	379161	referencia	32V6010
descripción	sensor de temperatura NTC 10kOhm cable termoplástico sonda -40 a +110°C cable -40 a +110°C bulbo ø6x14mm longitud de cable 3m sin racor de dos hilos		
Para modelos:	3G6SA, 3G6SA2, 3G6SA4, 40-OPR01, 40B-OPR01, 40BX-OPR01, 40CP, 40CP-OPR01, 40CPX, 40CPX-OPR01, 40EV-OPR01, 40PV-OPR01, 40X-OPR01, 4G6SB, 4G6SB2, 4G6SB4, 4G6SB6, 6BR15V, 6BR15VC, 6BR19V, 6BR19VC, 6EA, 6EA11, 6EA11A, 6EA11M, 6EA13, 6EA13A, 6EA13M, 6EA2, 6EA2A, 6EA2M, 6EAA, 6EAB, 6EABA, 6EABM, 6EAM, 6EB, 6EB11, 6EB11A, 6EB11M, 6EB13, 6EB13A, 6EB13M, 6EB2, 6EB22, 6EB22A, 6EB22M, 6EB2A, 6EB2M, 6EB4...(Otros modelos se puede ver en la tienda web)		

código	379064	referencia	8223470
descripción	sensor de temperatura PTC 1kOhm cable silicona sonda -50 a +150°C cable -50 a +180°C bulbo ø6x40mm longitud de cable 3m sin racor de dos hilos		

código	379487	referencia	32V0150
descripción	sensor de temperatura PTC cable silicona sonda -50 a +150°C cable -50 a +180°C bulbo ø6x30mm longitud de cable 2.5m sin racor de dos hilos		
Para modelos:	6BEA11A, 6BEA11B, 6BEA11M, 6BEA2A, 6BEA2B, 6BEA2M, 6BEA3A, 6BEA3B, 6BEA3M, 6BEAA, 6BEAB, 6BEABA, 6BEABB, 6BEABM, 6BEAM, 6BEB11A, 6BEB11B, 6BEB11M, 6BEB22A, 6BEB22B, 6BEB22M, 6BEB2A, 6BEB2B, 6BEB2M, 6BEB3A, 6BEB3B, 6BEB3M, 6BEB4A, 6BEB4B, 6BEB4M, 6BEBA, 6BEBB, 6BEBBA, 6BEBBB, 6BEBBM, 6BEBM, 6BEC11A, 6BEC11B, 6BEC11M, 6BEC22A, 6BEC22B, 6BEC22M, 6BEC2A, 6BEC2B, 6BEC2M, 6BEC33A, 6BEC33B, 6BEC33M, 6BEC3A, 6BEC3B...(Otros modelos se puede ver en la tienda web)		

sensores específicos del fabricante

código	379652	referencia	32Z3310
descripción	sensor de temperatura Pt100 cable fibra de vidrio sonda -200 a +600°C cable -50 a +350°C empalme de dos hilos rosca 1/4" bulbo ø6x40mm longitud de cable 1.4m		



código	379932	referencia	32Z6041
descripción	sensor de temperatura Pt100 cable silica sonda -100 a 450°C cable -50 a +180°C empalme de tres hilos rosca M10x1 bulbo ø3x130mm longitud de cable 1.5m		
Para modelos:	FCV101DM, FCV101DM-CSA, FCV101DS, FCV101DS-CSA, FCV101EDM, FCV101EDM-UL, FCV101EDS, FCV101EDS-UL, FCV141DM, FCV141DM-CSA, FCV141DS, FCV141DS-CSA, FCV141EDM, FCV141EDS, FCV241DM, FCV241DS, FCV241EDM, FCV241EDM-UL, FCV241EDS, FCV241EDS-UL, FCV241GDM, FCV241GDM-CSA, FCV241GDS, FCV241GDS-CSA, FCV401DM, FCV401DM-CSA, FCV401EDM, FCV401EDM-UL, FCV61DM, FCV61DM-CSA, FCV61DS, FCV61DS-CSA, FCV61EDM, FCV61EDM-UL, FCV61EDS, FCV61EDS-UL, FCV72EDM-UL, FCV72EDS-UL		

código	379934	referencia	32Z6191
descripción	sensor de temperatura Pt100 cable silica sonda -100 a 450°C cable -50 a +180°C empalme de tres hilos rosca M10x1 bulbo ø3x65mm longitud de cable 0.65m		
Para modelos:	FCV101, FCV101-CSA, FCV101DM, FCV101DM-CSA, FCV101DS, FCV101DS-CSA, FCV101E, FCV101EDM, FCV101EDM-UL, FCV101EDS, FCV101EDS-UL, FCV101E-UL, FCV141, FCV141-CSA, FCV141DM, FCV141DM-CSA, FCV141DS, FCV141DS-CSA, FCV141E, FCV141EDM, FCV141EDS, FCV241, FCV241DM, FCV241DS, FCV241E, FCV241EDM, FCV241EDM-UL, FCV241EDS, FCV241EDS-UL, FCV241E-UL, FCV241G, FCV241G-CSA, FCV241GDM, FCV241GDM-CSA, FCV241GDS, FCV241GDS-CSA, FCV3EM, FCV401DM, FCV401DM-CSA, FCV401EDM, FCV401EDM-UL, FCV4E, FCV4EDS, FCV4EM, FCV61, FCV61-CSA, FCV61DM, FCV61DM-CSA, FCV61DS, FCV61DS-CSA...(Otros modelos se puede ver en la tienda web)		

código	379892	referencia	32Z7410
descripción	sensor de temperatura Pt100 cable Vetrotex sonda -200 a +600°C cable -50 a +350°C empalme de dos hilos rosca bulbo ø6x80mm longitud de cable 1.5m		

código	379931	referencia	32Z6780
descripción	sensor de temperatura Pt100 cable Vetrotex sonda -200 a +600°C cable -50 a +350°C empalme de tres hilos rosca M10x1 bulbo ø4x85mm longitud de cable 0.8m		
Para modelos:	FCV4E, FCV4EDS		

código	379331	referencia	32V5750
descripción	sensor de temperatura Pt1000 cable PTFE sonda -70 a +500°C cable -40 a +250°C empalme de dos hilos rosca M10x1 bulbo ø3x60mm longitud de cable 0.7m		
Para modelos:	091FR1EX, 091FR1IA, 091FR1ID, 091FR1ID-VERS.052012, 10CP1EA, 10CP1GA, 10CP1IA, 12CP1EA, 12CP1GA, 12CP1IA, 18CP2EA, 18CP2GA, 18CP2IA, 191FR2ED, 191FR2ID, 191FR2ID-VERS.092012, BX101E, BX101E-VERS.122013, BX101G, BX101G-VERS.122013, BX122E, BX122E-VERS.122013, BX122G, BX122G-VERS.122013, BX61E, BX61E-VERS.122013, BX61G, BX61G-VERS.122013, BX82E, BX82E-VERS.122013, BX82G, BX82G-VERS.122013, FM1011E1, FM1011E1-VERS.2006, FM1011E2, FM1011E2-VERS.2006, FM1011E3, FM1011E3-VERS.2006, FM1011G1, FM1011G1-VERS.2006, FM1011G2, FM1011G2-VERS.2006, FM1011G3, FM1011G3-VERS.2006, FM1221E1, FM1221E1-VERS.2006, FM1221E2, FM1221E2-VERS.2006, FM1221E3, FM1221E3-VERS.2006...(Otros modelos se puede ver en la tienda web)		

código	378647	referencia	32V5760
descripción	sensor de temperatura Pt1000 cable Vetrotex sonda -70 a +500°C cable -50 a +350°C empalme de dos hilos rosca M10x1 bulbo ø3x100mm longitud de cable 1m		
Para modelos:	091FR1EA, 091FR1ED, 091FR7GS, 091FR7GX, 191FR2ED, FM1011E1, FM1011E1-VERS.2006, FM1011E2, FM1011E2-VERS.2006, FM1011E3, FM1011E3-VERS.2006, FM1011G1, FM1011G1-VERS.2006, FM1011G2, FM1011G2-VERS.2006, FM1011G3, FM1011G3-VERS.2006, FM1221E1, FM1221E1-VERS.2006, FM1221E2, FM1221E2-VERS.2006, FM1221E3, FM1221E3-VERS.2006, FM1221G1, FM1221G1-VERS.2006, FM1221G2, FM1221G2-VERS.2006, FM1221G3, FM1221G3-VERS.2006, FM2011E2-VERS.2006, FM2011E3-VERS.2006, FM2011G2-VERS.2006, FM2011G3-VERS.2006, FM2021E1, FM2021E2, FM2021E2-VERS.2006, FM2021E3, FM2021E3-VERS.2006, FM2021G1, FM2021G2, FM2021G2-VERS.2006, FM2021G3, FM2021G3-VERS.2006, FM611E1, FM611E1-VERS.2006, FM611E2, FM611E2-VERS.2006, FM611E3, FM611E3-VERS.2006, FM611G1...(Otros modelos se puede ver en la tienda web)		

código	379789	referencia	3104950
descripción	sensor de temperatura termopar J (Fe-CuNi) cable fibra de vidrio sonda -50 a +750°C cable -50 a +350°C empalme conector Faston 2,8mm rosca bulbo ø4x40mm longitud de cable 1m		
Para modelos:	04WPPEBV, 08WPPEBV, 08WTPEV, 090PEB, 091PEB, 190PEB, 190TPE, 191PEB, 191TPE		

código	379910	referencia	32V0030
descripción	sensor de temperatura termopar J (Fe-CuNi) cable silica sonda -50 a 1150°C cable -50 a +180°C empalme conector Faston 2,8mm rosca M10x1 bulbo ø4/6x72mm longitud de cable 0.6m		
Para modelos:	04WFR3ED, 06WFR3GD, 091FR1ED, 091FR1GD, 091FR3ED, 091FR3GD, 0A1FR1ED, 0A1FR1GD, 0A1FR1GD-VERS.2004, 0A1FR3ED, 0A1FR3GD, 0B1FR1GD, 0D1FR1ED, 0D1FR1GD, 0D1FR1GD-VERS.2004, 0D1FR3ED, 0D1FR3GD, 0G0FR3ED, 0G1FR3GD, 10WFR4GD, 191FR2ED, 191FR2G, 191FR2GD, 191FR4ED, 191FR4GD, 1A1FR2ED, 1A1FR2GD, 1A1FR2GD-VERS.2004, 1A1FR4ED, 1A1FR4GD, 1D1FR2ED, 1D1FR2GD, 1D1FR2GD-VERS.2004, 1D1FR4ED, 1D1FR4GD, 1G1FR4GD, 6FR		

sondas al corazón

código	378550	referencia	32V8360
descripción	sensor al corazón NTC 10kOhm cable silica sonda -40 a +120°C cable -50 a +180°C empalme de dos hilos bulbo ø4,5x100mm rosca longitud de cable 3.8m asidero ø 16mm longitud de asidero 120mm		
Para modelos:	DS31, DS31A, DS31C, DS31M, DS351H, DS51, DS51A, DS51C, DS51M		



código	379890	referencia	32Z6010
descripción	sensor al corazón Pt100 cable inox flexible ondulado sonda -40 a +250°C cable -40 a +250°C empalme de dos hilos bulbo ø4x100mm rosca M16x1,5 longitud de cable 1.6m asidero ø 8.5mm longitud de asidero 100mm		



código	379933	referencia	32Z1982 32Z1983
descripción	sensor al corazón Pt100 cable PTFE sonda -40 a +250°C cable -40 a +250°C empalme de tres hilos bulbo ø2,5x100mm rosca longitud de cable 2.75m asidero ø 15mm longitud de asidero 90mm		
Para modelos:	FCV101DM, FCV101DM-CSA, FCV101DS, FCV101DS-CSA, FCV101EDM, FCV101EDM-UL, FCV101EDS, FCV101EDS-UL, FCV141DM, FCV141DM-CSA, FCV141DS, FCV141DS-CSA, FCV141EDM, FCV141EDS, FCV241DM, FCV241DS, FCV241EDM, FCV241EDM-UL, FCV241EDS, FCV241EDS-UL, FCV241GDM, FCV241GDS, FCV241GDS-CSA, FCV401DM, FCV401DM-CSA, FCV401EDM, FCV401EDM-UL, FCV4EDS, FCV61DM, FCV61DM-CSA, FCV61DS, FCV61DS-CSA, FCV61EDM, FCV61EDM-UL, FCV61EDS, FCV61EDS-UL, FCV72EDM-UL, FCV72EDS-UL		

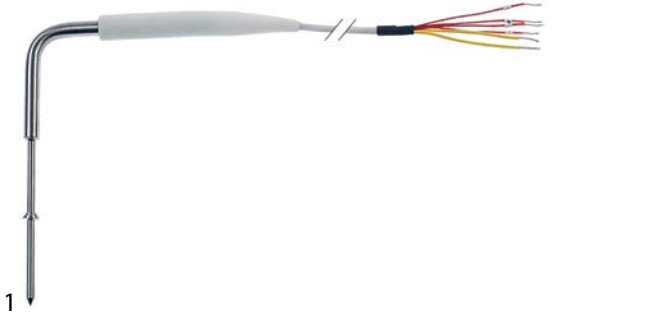

código	378402 ¹	referencia	32V7960
descripción	sensor al corazón Pt100 cable silicona sonda -40 a +120°C cable -50 a +180°C empalme de cinco hilos bulbo ø5x175mm rosca longitud de cable 3.5m asidero ø 16mm longitud de asidero 125mm		
Para modelos:	FS611, IA101L, IA101S, IA51, IA51A, IA51C, IA51M, IA72S, IS101L, IS101LR, IS101LW, IS101S, IS101SR, IS101SW, IS102S, IS102SR, IS102SR-ONR01, IS102SW, IS51, IS51A, IS51AR, IS51C, IS51CR, IS51H, IS51HW, IS51M, IS51MR, IS51R, IS51W, IS51WA, IS51WC, IS51WM, IS72S, IS72SR, IS72SW, ISFEB, ISFEB-OPR01, ISFEN, ISFEN-OPR01, ISP202R, ISR201R, ISR202R		

¹sensor multipunto



código	379891	referencia	32Z6830
descripción	sensor al corazón Pt100 cable silicona sonda -40 a +120°C cable -50 a +180°C empalme de tres hilos bulbo ø3,5-5,5x100mm rosca longitud de cable 1.85m asidero ø 12mm longitud de asidero 100mm		



código	378264	referencia	3159510 3159511 3200361
descripción	sensor al corazón Pt1000 cable PTFE sonda -40 a +250°C cable -40 a +250°C empalme de cinco hilos bulbo ø3x100mm rosca longitud de cable 2.7m asidero ø 13mm longitud de asidero 75mm		
Para modelos:	FM101E3, FM101G3, FM1221E3, FM1221G3, FM2021E3, FM2021G3, FM611E3, FM611G3, FM721E3, FM721G3		



código	403452	referencia	6300643
descripción	sensor al corazón Pt1000 cable PTFE sonda -40 a +250°C cable -40 a +250°C empalme de dos hilos bulbo ø3x100mm rosca longitud de cable 3.2m asidero ø 13mm longitud de asidero 60mm		
Para modelos:	FM1011E2-VERS.2006, FM1011G2-VERS.2006, FM1221E2-VERS.2006, FM1221G2-VERS.2006, FM2011E2-VERS.2006, FM2011G2-VERS.2006, FM2021E2-VERS.2006, FM2021G2-VERS.2006, FM611E2-VERS.2006, FM611G2-VERS.2006, FM721E2-VERS.2006, FM721G2-VERS.2006		

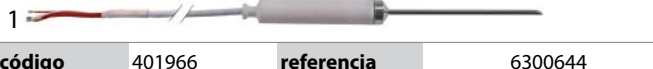

código	401966	referencia	6300644
descripción	sensor al corazón Pt1000 cable PTFE sonda -40 a +250°C cable -40 a +250°C empalme de tres hilos bulbo ø3x100mm rosca longitud de cable 1.5m asidero ø 13mm longitud de asidero 75mm		
Para modelos:	FM1011E3-VERS.2006, FM1011G3-VERS.2006, FM1221E3-VERS.2006, FM1221G3-VERS.2006, FM2011E3-VERS.2006, FM2011G3-VERS.2006, FM2021E3-VERS.2006, FM2021G3-VERS.2006, FM611E3-VERS.2006, FM611G3-VERS.2006, FM721E3-VERS.2006, FM721G3-VERS.2006		



código	379588	referencia	3139610 32V5940
descripción	sensor al corazón Pt1000 cable termoplástico sonda -40 a +250°C cable -40 a +110°C empalme de dos hilos bulbo ø3x110mm rosca longitud de cable 3.1m asidero ø 13mm longitud de asidero 70mm		
Para modelos:	FM1011E2, FM1011G2, FM1221E2, FM1221G2, FM2021E2, FM2021G2, FM423E2, FM611E2, FM611G2, FM721E2, FM721G2, FX101E2, FX101E2C, FX101E2C-VERS.032014, FX101E2R, FX101E2R-VERS.032014, FX101E2-VERS.032014, FX101G2, FX101G2C, FX101G2C-VERS.032014, FX101G2R, FX101G2R-VERS.032014, FX101G2-VERS.032014, FX10E2CR, FX10E2CR-VERS.032014, FX10G2CR, FX10G2CR-VERS.032014, FX122E2, FX122E2C, FX122E2T, FX122E2T-VERS.032014, FX122G2, FX122G2C, FX122G2T, FX122G2T-VERS.032014, FX201E2, FX201E2P, FX201E2P-VERS.032014, FX201E2-VERS.032014, FX201G2, FX201G2P, FX201G2P-VERS.032014, FX201G2-VERS.032014, FX202E2, FX202E2-VERS.032014, FX202G2, FX202G2-VERS.032014, FX61E2, FX61E2C, FX61E2CR...(Otros modelos se puede ver en la tienda web)		



código	381511	referencia	72378
descripción	sensor al corazón Pt1000 empalme de seis hilos bulbo ø3,2x100mm longitud de cable 3.1m asidero ø 13mm longitud de asidero 70mm horno a vapor combinado		

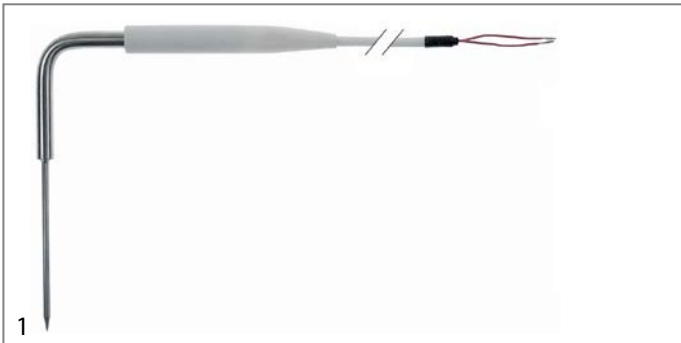

código	378186	referencia	32V0010 32V0441 32V8600
descripción	sensor al corazón PTC 1kOhm cable silicona sonda -40 a +120°C cable -50 a +180°C empalme de dos hilos bulbo ø4x90mm rosca longitud de cable 3.8m asidero ø 15mm longitud de asidero 120mm L1 175mm L2 190mm		
Para modelos:	ART1LD, ART1LD7, ART1LD7A, ART1LD7M, ART1LDA, ART2LD, ART2SD, ART3SD, SM14SR, SM1L, SM1L7, SM1L7A, SM1L7FCV, SM1L7M, SM1LA, SM1LAR, SM1LAT, SM1LAW, SM1LR, SM1LT, SM1LT7, SM1LT7A, SM1LT7M, SM1LW, SM2L, SM2LR, SM2LW, SM2S, SM2SR, SM2SW, SM3S, SM3SR, SM4SR, SM7SR		



código	519385	referencia	3150220
descripción	junta para sensor de temperatura al corazón ø ext. 8mm int.ø 4mm espesor 5mm		
Para modelos:	FCV101DM, FCV101DM-CSA, FCV101DS, FCV101DS-CSA, FCV101EDM, FCV101EDM-UL, FCV101EDS, FCV101EDS-UL, FCV141DM, FCV141DM-CSA, FCV141DS, FCV141DS-CSA, FCV141EDM, FCV141EDS, FCV241DM, FCV241DS, FCV241EDM, FCV241EDM-UL, FCV241EDS, FCV241EDS-UL, FCV241GDM, FCV241GDM-CSA, FCV241GDS, FCV241GDS-CSA, FCV401DM, FCV401DM-CSA, FCV401EDM, FCV401EDM-UL, FCV4EDS, FCV61DM, FCV61DM-CSA, FCV61DS, FCV61DS-CSA, FCV61EDM, FCV61EDM-UL, FCV61EDS, FCV61EDS-UL, FCV72EDM-UL, FCV72EDS-UL, FM1011E2, FM1011E3, FM1011G2, FM1011G3, FM1221E2, FM1221E3, FM1221G2, FM1221G3, FM2021E2, FM2021E3, FM2021G2... (Otros modelos se puede ver en la tienda web)		

accesorios

uniones roscadas



código	401967	referencia	3004870
descripción	unión roscada para sensor de temperatura al corazón		
Para modelos:	FM1011E2, FM1011E2-VERS.2006, FM1011E3, FM1011E3-VERS.2006, FM1011G2, FM1011G2-VERS.2006, FM1011G3, FM1011G3-VERS.2006, FM1221E2, FM1221E2-VERS.2006, FM1221E3, FM1221E3-VERS.2006, FM1221G2, FM1221G2-VERS.2006, FM1221G3, FM1221G3-VERS.2006, FM2011E2-VERS.2006, FM2011E3-VERS.2006, FM2011G2-VERS.2006, FM2011G3-VERS.2006, FM2021E2, FM2021E2-VERS.2006, FM2021E3, FM2021E3-VERS.2006, FM2021G2, FM2021G2-VERS.2006, FM2021G3, FM2021G3-VERS.2006, FM611E2, FM611E2-VERS.2006, FM611E3, FM611E3-VERS.2006, FM611G2, FM611G2-VERS.2006, FM611G3, FM611G3-VERS.2006, FM721E2, FM721E2-VERS.2006, FM721E3, FM721E3-VERS.2006, FM721G2, FM721G2-VERS.2006, FM721G3, FM721G3-VERS.2006, FX101E2, FX101E2C, FX101E3, FX101E3C, FX101E3R, FX101G2... (Otros modelos se puede ver en la tienda web)		

electrónicas

placas electrónicas

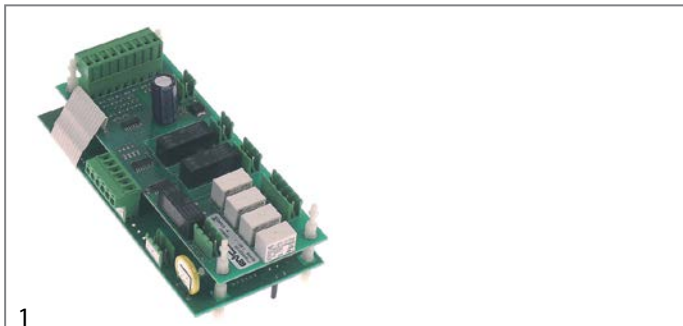

código	401747	referencia	32V8030
descripción	placa de potencia para abatidor de temperatura SERIE IM apto para SAGI		
Para modelos:	FS611, IS101L, IS101LW, IS101S, IS101SW, IS102S, IS102SR, IS102SW, IS51, IS51A, IS51C, IS51H, IS51HW, IS51M, IS51W, IS51WA, IS51WC, IS51WM, IS72S, IS72SW, ISFEB, ISFEB-OPRO1, ISFEN, ISFEN-OPRO1		

otros



código	691159	referencia	35Q6360
descripción	chapa protectora para sonda		
Para modelos:	FC101, FC101E, FC241, FC241E, FC241G, FC61, FC61E, FCV101, FCV101-CSA, FCV101DM, FCV101DM-CSA, FCV101DS, FCV101DS-CSA, FCV101E, FCV101EDM, FCV101EDM-UL, FCV101EDS, FCV101EDS-UL, FCV101E-UL, FCV141, FCV141-CSA, FCV141DM, FCV141DM-CSA, FCV141DS, FCV141DS-CSA, FCV141E, FCV141EDM, FCV141EDS, FCV241, FCV241DM, FCV241DS, FCV241E, FCV241EDM, FCV241EDM-UL, FCV241EDS, FCV241EDS-UL, FCV241E-UL, FCV241G, FCV241G-CSA, FCV241GDM, FCV241GDM-CSA, FCV241GDS, FCV241GDS-CSA, FCV401DM, FCV401DM-CSA, FCV401EDM, FCV401EDM-UL, FCV4E, FCV4EDS, FCV61... (Otros modelos se puede ver en la tienda web)		



código	401183	referencia	32Z6621 32Z6622
descripción	placa de teclado		
Para modelos:	FCV4E		



código	401184	referencia	32Z1081 32Z1082
descripción	placa de teclado		
Para modelos:	FCV4EDS		

1

código	401748	referencia	3049200
descripción	placa de teclado		
Para modelos:	IS101LR, IS101SR, IS102SR, IS102SR-0NR01, IS51AR, IS51CR, IS51MR, IS51R, IS72SR		



1

código	401218	referencia	32Z6210 32Z6211
descripción	placa electrónica		
Para modelos:	FCV101, FCV101E, FCV141, FCV141E, FCV241, FCV241E, FCV241G, FCV3EM, FCV4EM, FCV61, FCV61E		



1

código	401750	referencia	32Z8940
descripción	placa de teclado		
Para modelos:	SM2L, SM2LR, SM2LW, SM2S, SM2SR, SM2SW, SM3S, SM3SR, SM4SR		



1

código	401749	referencia	32Z9640
descripción	placa electrónica		
Para modelos:	SM1L, SM1LA, SM1LAR, SM1LAW, SM1LR, SM1LW, SM2L, SM2LR, SM2LW, SM2S, SM2SR, SM2SW, SM3S, SM3SR, SM4SR		





1

código	401751	referencia	32Z8240
descripción	placa de teclado		
Para modelos:	SM1L, SM1LA, SM1LAR, SM1LAW, SM1LR, SM1LW		



1

código	400955	referencia	3019810	
descripción	placa electrónica cortadora de fiambre 230/400V			
Para modelos:	STV			
accesorios para	400955			
	código	401357	referencia	—
	pulsador medida de montaje ø22mm 1NO/1NC/lámpara 400V 4A lámpara 24V 0-l empalme atornillado temperatura ambiente máx. 125/55°C protección IP40			
	código	401709	referencia	—
	cubierta protectora dimensiones exteriores 57x32mm dimensión interior 47x22mm mate goma H 27.5mm			



1

código	402867	referencia	3018770 3018771
descripción	placa de teclado horno a vapor combinado FM1011 L 275mm An 100mm apto para ANGELO PO tazas 12		
Para modelos:	FM1011E1, FM1011E2, FM1011E3, FM1011G1, FM1011G2, FM1011G3, FM1221E1, FM1221E2, FM1221E3, FM1221G1, FM1221G2, FM1221G3, FM2021E1, FM2021E2, FM2021E3, FM2021G1, FM2021G2, FM2021G3, FM611E1, FM611E2, FM611E3, FM611G1, FM611G2, FM611G3, FM721E1, FM721E2, FM721E3, FM721G1, FM721G2, FM721G3		



1

código	403575	referencia	32Z7090
descripción	placa electrónica cortadora de fiambre L 128mm An 43mm aliment. 230-400V		
Para modelos:	AFC30MS, AFC30S, AFC35, AFT30S, AFT30VMS, AFT30VS, AFT33S, AFT35, AFT35VS		



1

código	400954	referencia	3069870
descripción	placa electrónica cortadora de fiambre/cúter 50/60Hz 230V		
Para modelos:	SC9VV, STV		



1

código	400678	referencia	32Z9090
descripción	placa electrónica freidora 091FR1 ED 230V		
Para modelos:	04WFR3ED, 06WFR3GD, 08WFR4ED, 091FR1ED, 091FR1GD, 091FR3ED, 091FR3GD, 0A1FR1ED, 0A1FR1GD, 0A1FR1GD-VERS.2004, 0A1FR3ED, 0A1FR3GD, 0B1FR1GD, 0D1FR1ED, 0D1FR1GD, 0D1FR1GD-VERS.2004, 0D1FR3ED, 0D1FR3GD, 0G0FR3ED, 0G1FR3GD, 10WFR4GD, 191FR2ED, 191FR2GD, 191FR4ED, 191FR4GD, 1A1FR2ED, 1A1FR2GD, 1A1FR2GD-VERS.2004, 1A1FR4ED, 1A1FR4GD, 1D1FR2ED, 1D1FR2GD, 1D1FR2GD-VERS.2004, 1D1FR4ED, 1D1FR4GD, 1G1FR4GD		



1

código	402866	referencia	32V5360 32V5361
descripción	placa electrónica horno a vapor combinado FM1011 apto para ANGELO PO		
Para modelos:	FM1011E1, FM1011E1-VERS.2006, FM1011E2, FM1011E2-VERS.2006, FM1011E3, FM1011G1, FM1011G1-VERS.2006, FM1011G2, FM1011G2-VERS.2006, FM1011G3, FM1221E1, FM1221E1-VERS.2006, FM1221E2, FM1221E2-VERS.2006, FM1221E3, FM1221G1, FM1221G1-VERS.2006, FM1221G2, FM1221G2-VERS.2006, FM1221G3, FM2011E2-VERS.2006, FM2011G2-VERS.2006, FM2021E1, FM2021E2, FM2021E2-VERS.2006, FM2021G1, FM2021G2, FM2021G2-VERS.2006, FM611E1, FM611E1-VERS.2006, FM611E2, FM611E2-VERS.2006, FM611E3, FM611G1, FM611G1-VERS.2006, FM611G2, FM611G2-VERS.2006, FM611G3, FM721E1, FM721E1-VERS.2006, FM721E2, FM721E2-VERS.2006, FM721G1, FM721G1-VERS.2006, FM721G2, FM721G2-VERS.2006		



1

código	402978	referencia	3184480
descripción	placa electrónica L 73mm An 73mm temporizador		
Para modelos:	PG22C, PG23C, PG23CW, PG24CW, PG30C, PG31CW, PG42C, PG43CW, PG60C, PG61CW		

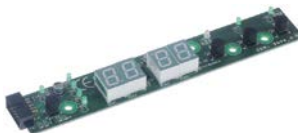

1

código	402675	referencia	3104130
descripción	placa electrónica lavavajillas KD60 L 185mm An 30mm tazas 4		
Para modelos:	KD40EPSD, KD40LEPS, KD40LUXE, KD60E, KD60EAT, KD60ME, KD85E, KD85EA, KD85EAT, KD85EPS, KD85EPSA, LP70		
accesorios para	402675		
	código	400066	referencia 3099170
	cable de cinta plana 10 polos L 1000mm tipo de conector FC-10P medida reticular 2.54mm		

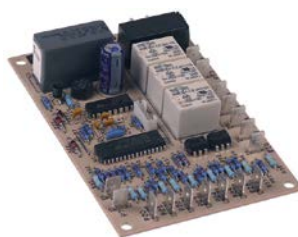

1

código	401029	referencia	3026600 3114850
descripción	placa electrónica lavavajillas LF 50 L 122mm An 80mm UE 1 pzs		
Para modelos:	LF50EM, LF50EMPS, LF50E-VERS.2007		



1

código	403255	referencia	3207870
descripción	placa electrónica lavavajillas N700/NE1300/S026/S030 L 135mm An 82mm		
Para modelos:	LF50EM, LF50EMPS, LF50EMPS-VERS.122012, LF50EM-VERS.122012, LF50E-VERS.122012, LF50E-VERS.2007		

			
código	404028	referencia	6300751
descripción	placa electrónica para horno a vapor combinado ANGELO PO L 140mm An 100mm		
Para modelos:	BX101G, BX101G-VERS.122013, BX122G, BX122G-VERS.122013, BX61G, BX61G-VERS.122013, BX82G, BX82G-VERS.122013, FX101G1, FX101G1R, FX101G2, FX101G2C, FX101G2C-VERS.032014, FX101G2R, FX101G2R-VERS.032014, FX101G2-VERS.032014, FX101G3, FX101G3C, FX101G3C-VERS.022014, FX101G3R, FX101G3R-VERS.022014, FX101G3-VERS.022014, FX10G2CR, FX10G2CR-VERS.032014, FX10G3CR, FX10G3CR-VERS.022014, FX122G1, FX122G2, FX122G2C, FX122G2T, FX122G2T-VERS.032014, FX122G3, FX122G3C, FX122G3T, FX122G3T-VERS.022014, FX12G3CT, FX12G3CT-VERS.022014, FX201G2, FX201G2P, FX201G2P-VERS.032014, FX201G2-VERS.032014, FX201G3P, FX201G3-VERS.022014, FX202G2, FX202G2-VERS.032014, FX202G3, FX202G3-VERS.022014, FX61G1, FX61G1R, FX61G2...(Otros modelos se puede ver en la tienda web)		

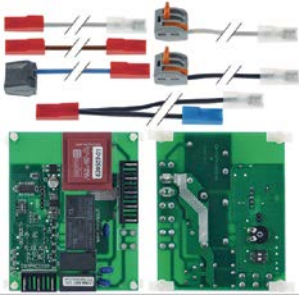
			
código	403687	referencia	3034260 32V4350
descripción	temporizador electrónico para máquina de hielo Simag medida de montaje 90x70mm 230		
Para modelos:	PG22C, PG23C, PG23CW, PG24CW, PG30C, PG31CW, PG42C, PG43CW, PG60C, PG61CW, PG80C, PG81CW, PGC132, PGC134W, PGC210, PGC212W		

			
código	400677	referencia	32V0780
descripción	platina de control freidora 091FR1 ED		
Para modelos:	04WFR3ED, 06WFR3GD, 08WFR4ED, 091FR1ED, 091FR1GD, 091FR3ED, 091FR3GD, 0A1FR1ED, 0A1FR1GD, 0A1FR1GD-VERS.2004, 0A1FR3ED, 0A1FR3GD, 0B1FR1GD, 0D1FR1ED, 0D1FR1GD, 0D1FR1GD-VERS.2004, 0D1FR3ED, 0D1FR3GD, 0G0FR3ED, 0G1FR3GD, 10WFR4GD, 191FR2ED, 191FR2GD, 191FR4ED, 191FR4GD, 1A1FR2ED, 1A1FR2GD, 1A1FR2GD-VERS.2004, 1A1FR4ED, 1A1FR4GD, 1D1FR2ED, 1D1FR2GD, 1D1FR2GD-VERS.2004, 1D1FR4ED, 1D1FR4GD, 1G1FR4GD		

teclados

membranas de teclado

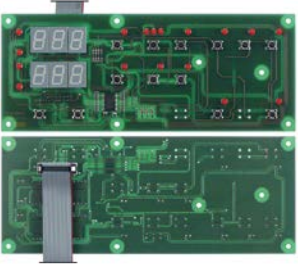
			
código	403729	referencia	32V3060
descripción	platina de control L 203mm An 80mm		
Para modelos:	SM2L, SM2LR, SM2LW, SM2S, SM2SR, SM2SW, SM3S, SM3SR, SM4SR, SM7SR		

			
código	401180	referencia	37M4201
descripción	membrana de teclado		
Para modelos:	FC101, FC101E, FC241, FC241E, FC241G, FC61, FC61E		

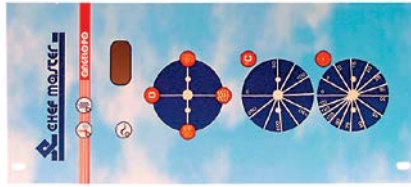
			
código	401181	referencia	37M9220
descripción	membrana de teclado		
Para modelos:	FCV3EM, FCV4EM		

			
código	401182	referencia	37M5641
descripción	membrana de teclado		
Para modelos:	FCV101, FCV101E, FCV141, FCV141E, FCV241, FCV241E, FCV241G, FCV61, FCV61E		



válvulas magnéticas

válvulas magnéticas agua

ELBI

recto



código	374053	referencia	3032680
descripción	válvula magnética simple recto 230VAC entrada 3/4" salida 11,5mm T máx 60°C ELBI plástico reducción salida naranja		
Para modelos:	BX101E, BX101E-VERS.122013, BX101G, BX101G-VERS.122013, BX122E, BX122E-VERS.122013, BX122G, BX122G-VERS.122013, BX61E, BX61E-VERS.122013, BX61G, BX61G-VERS.122013, BX82E, BX82E-VERS.122013, BX82G, BX82G-VERS.122013, FM1011E1, FM1011E1-VERS.2006, FM1011E2, FM1011E2-VERS.2006, FM1011E3, FM1011E3-VERS.2006, FM1011G1, FM1011G1-VERS.2006, FM1011G2, FM1011G2-VERS.2006, FM1011G3, FM1011G3-VERS.2006, FM1221E1, FM1221E1-VERS.2006, FM1221E2, FM1221E2-VERS.2006, FM1221E3, FM1221E3-VERS.2006, FM1221G1, FM1221G1-VERS.2006, FM1221G2, FM1221G2-VERS.2006, FM1221G3, FM1221G3-VERS.2006, FM2021E1, FM2021E2, FM2021G1, FM2021G2, FM423E2, FM611E1, FM611E1-VERS.2006, FM611E2, FM611E2-VERS.2006, FM611E3...(Otros modelos se puede ver en la tienda web)		



código	370431	referencia	33D2780
descripción	válvula magnética simple recto 230VAC entrada 3/4" salida 11,5mm reducción entrada Al/min reducción salida 2l/min DN10 T máx 90°C ELBI plástico		
Para modelos:	PGC132, PGC132-VERS.200911, PGC134W, PGC134W-VERS.200911, PGC210, PGC210-VERS.200911, PGC212W, PGC212W-VERS.200911		

MÜLLER

temperatura líquido: 90°C
ciclo de trabajo: 100%



código	370158	referencia	33D1710 33D2410
descripción	válvula magnética doble recto 230VAC entrada 3/4" salida 11,5mm DN10 T máx 90°C ciclo de trabajo 100% MÜLLER		
Para modelos:	FC101, FC101E, FC241E, FC241G, FC61, FC61E, FCV101, FCV101-CSA, FCV101DM, FCV101DM-CSA, FCV101DS, FCV101DS-CSA, FCV101E, FCV101EDM, FCV101EDM-UL, FCV101EDS, FCV101EDS-UL, FCV101E-UL, FCV141, FCV141-CSA, FCV141DM, FCV141DM-CSA, FCV141DS, FCV141DS-CSA, FCV141E, FCV141EDM, FCV141EDS, FCV241E, FCV241EDM, FCV241EDM-UL, FCV241EDS, FCV241EDS-UL, FCV241E-UL, FCV241G, FCV241G-CSA, FCV241GDM, FCV241GDM-CSA, FCV241GDS, FCV241GDS-CSA, FCV401DM, FCV401DM-CSA, FCV401EDM, FCV401EDM-UL, FCV61, FCV61-CSA, FCV61DM, FCV61DM-CSA, FCV61DS, FCV61DS-CSA, FCV61E...(Otros modelos se puede ver en la tienda web)		
repuestos para	370158		
	código	370195	referencia —
	cuerpo de válvula magnética doble recto entrada 3/4" salida 11,5mm DN10 T máx 90°C ciclo de trabajo 100% MÜLLER 230V		
	código	371002	referencia —
	soporte de válvula magnética MÜLLER portabridas		
	código	371009	referencia —
	resorte de compresión para solenoide		
	código	371011	referencia —
	kit de piezas de repuesto membrana con estrella larga anchura estrella 8mm MÜLLER		
	código	371017	referencia —
	bobina magnética MÜLLER 230VAC empalme conector Faston 6,3mm		
	código	371122	referencia —
	filtro de válvula magnética ø 19mm H 10mm apto para MÜLLER		
accesorios para	370158		
	código	371010	referencia —
	bobina magnética 230VAC empalme con cable longitud del cable 2000mm		
	código	371037	referencia —
	bobina magnética 24VAC 50/60Hz empalme conector Faston 6,3mm		
	código	371038	referencia —
	bobina magnética 230VAC empalme conector		

			
1			
código	370117	referencia	33D2460
descripción	válvula magnética simple recto 230VAC entrada 3/4" salida 11,5mm DN10T máx 90°C ciclo de trabajo 100% MÜLLER		
Para modelos:	FM1011E3, FM1011G3, FM1221E1, FM1221E2, FM1221E3, FM1221G1, FM1221G2, FM1221G3, FM611E3, FM611G3, FM721E1, FM721E2, FM721E3, FM721G1, FM721G2, FM721G3		
repuestos para	370117		
	código	referencia	—
	370133		
	cuerpo de válvula magnética simple recto entrada 3/4" salida 11,5mm DN10T máx 90°C ciclo de trabajo 100% MÜLLER 230V		
	371002		
	soporte de válvula magnética MÜLLER portabridas		
	371009		
	resorte de compresión para solenoide		
	371011		
	kit de piezas de repuesto membrana con estrella larga anchura estrella 8mm MÜLLER		
	371017		
	bobina magnética MÜLLER 230VAC empalme conector Faston 6,3mm		
	371122		
	filtro de válvula magnética ø 19mm H 10mm apto para MÜLLER		
	501161		
	montura para válvula magnética soporte para solenoides		
accesorios para	370117		
	código	referencia	—
	371010		
	bobina magnética 230VAC empalme con cable longitud del cable 2000mm		
	371037		
	bobina magnética 24VAC 50/60Hz empalme conector Faston 6,3mm		
	371038		
	bobina magnética 230VAC empalme conector		

ROBERTSHAW/INVENSYS

temperatura líquido: 90°C 90°C 60°C
 temperatura ambiente: 60°C 25°C 60°C
 ciclo de trabajo: 40% 100% 100%

recambios y accesorios

reducciones

salida















			
1			
código	371255	referencia	N/A
descripción	reducción tipo EATON (INVENSYS) velocidad de flujo 5l/min margen de presión 0 a 10bar tolerancia ±15/25% negro		





RPE













			
1			
código	374017	referencia	33D2310 33D3260
descripción	válvula magnética simple recto 230VAC entrada 3/4" salida 10mm reducción entrada A 6l/min DN10 RPE poliamida reducción entrada A blanco membrana NBR margen de presión 0,2-10bar		

			
1			
código	374015	referencia	33D3280
descripción	válvula magnética simple acodado 230VAC entrada 3/4" salida 10mm reducción entrada A 10-12l/min DN10 RPE reducción entrada A blanco		
Para modelos:	KD100, KD100A, KD100PSD, KD130, KD130A, KD130E, KD130EAT, KD85, KD85A, KD85PS, KD85PSA, KN1100, KN1100SD, KN11PSDD, KN800, KN800PSD, LP151		











TP			
 			
1			
código	370021	referencia	33D1640 33D1641 33D3250
descripción	válvula magnética doble recto 230VAC entrada 3/4" salida 11,5mm DN10 TP reducción entrada A blanco		
Para modelos:	FC101, FC101E, FC241, FC241E, FC241G, FC61, FC61E, FCV101, FCV101DM, FCV101DS, FCV101E, FCV101EDM, FCV101EDS, FCV141, FCV141DM, FCV141DS, FCV141E, FCV141EDM, FCV141EDS, FCV241, FCV241DM, FCV241DS, FCV241E, FCV241EDM, FCV241EDS, FCV241G, FCV241GDM, FCV241GDS, FCV3EM, FCV401DM, FCV401EDM, FCV4E, FCV4EDS, FCV4EM, FCV61, FCV61DM, FCV61DS, FCV61E, FCV61EDM, FCV61EDS, FM423E1, KD37, KD37PS, KD37-VERS.112009, KD40, KD40EPSD, KD40LEPS, KD40LSPS, KD40LUX, KD40LUXE... (Otros modelos se puede ver en la tienda web)		
accesorios para	370021		
	código	371220	referencia —
		reducción TP velocidad de flujo 3l/min rojo tolerancia ±15%	
	código	371221	referencia —
		reducción TP velocidad de flujo 5.5l/min amarillo tolerancia ±15%	
	código	371222	referencia —
		reducción TP velocidad de flujo 6l/min gris tolerancia ±15%	
	código	371223	referencia —
		reducción TP velocidad de flujo 10l/min blanco tolerancia ±15%	
	código	371224	referencia —
		reducción TP velocidad de flujo 12l/min bronce tolerancia ±15%	
	código	371225	referencia —
		reducción TP velocidad de flujo 16l/min marrón claro tolerancia ±15%	
	código	371226	referencia —
		reducción TP velocidad de flujo 20l/min rojo tolerancia ±15%	
	código	371230	referencia —
		reducción TP velocidad de flujo 0.25l/min rojo tolerancia ±25%	
	código	371231	referencia —
		reducción TP velocidad de flujo 0.35l/min violeta tolerancia ±25%	
	código	371232	referencia —
		reducción TP velocidad de flujo 0.5l/min naranja tolerancia ±25%	
	código	371233	referencia —
		reducción TP velocidad de flujo 0.8l/min blanco tolerancia ±25%	
	código	371234	referencia —
		reducción TP velocidad de flujo 1l/min azul claro tolerancia ±25%	
	código	371235	referencia —
		reducción TP velocidad de flujo 1.2l/min marrón tolerancia ±25%	













accesorios para 370021			
	código	371236	referencia —
		reducción TP velocidad de flujo 1.5l/min marrón claro tolerancia ±25%	
	código	371237	referencia —
		reducción TP velocidad de flujo 2.5l/min amarillo tolerancia ±25%	
	código	371238	referencia —
		reducción TP velocidad de flujo 3.4l/min verde oscuro tolerancia ±25%	
	código	371239	referencia —
		reducción TP velocidad de flujo 5l/min negro tolerancia ±25%	
	código	371240	referencia —
		reducción TP velocidad de flujo 8l/min azul tolerancia ±20%	



TP			
 			
1			
código	370017	referencia	33D1370 33D2310
descripción	válvula magnética simple recto 230VAC entrada 3/4" salida 11,5mm DN10 TP p máx. 10bar		
repuestos para	370017		
	código	371013	referencia —
		bobina magnética TP 230VAC 50/60Hz	
accesorios para	370017		
	código	371220	referencia —
		reducción TP velocidad de flujo 3l/min rojo tolerancia ±15%	
	código	371221	referencia —
		reducción TP velocidad de flujo 5.5l/min amarillo tolerancia ±15%	
	código	371222	referencia —
		reducción TP velocidad de flujo 6l/min gris tolerancia ±15%	
	código	371223	referencia —
		reducción TP velocidad de flujo 10l/min blanco tolerancia ±15%	
	código	371224	referencia —
		reducción TP velocidad de flujo 12l/min bronce tolerancia ±15%	
	código	371225	referencia —
		reducción TP velocidad de flujo 16l/min marrón claro tolerancia ±15%	
	código	371226	referencia —
		reducción TP velocidad de flujo 20l/min rojo tolerancia ±15%	
	código	371230	referencia —
		reducción TP velocidad de flujo 0.25l/min rojo tolerancia ±25%	
	código	371231	referencia —
		reducción TP velocidad de flujo 0.35l/min violeta tolerancia ±25%	

Continúa en la página siguiente

accesorios para		370017	
	código	371232	referencia —
reducción TP velocidad de flujo 0.5l/min naranja tolerancia ±25%			
	código	371233	referencia —
reducción TP velocidad de flujo 0.8l/min blanco tolerancia ±25%			
	código	371234	referencia —
reducción TP velocidad de flujo 1l/min azul claro tolerancia ±25%			
	código	371235	referencia —
reducción TP velocidad de flujo 1.2l/min marrón tolerancia ±25%			
	código	371236	referencia —
reducción TP velocidad de flujo 1.5l/min marrón claro tolerancia ±25%			
	código	371237	referencia —
reducción TP velocidad de flujo 2.5l/min amarillo tolerancia ±25%			
	código	371238	referencia —
reducción TP velocidad de flujo 3.4l/min verde oscuro tolerancia ±25%			
	código	371239	referencia —
reducción TP velocidad de flujo 5l/min negro tolerancia ±25%			
	código	371240	referencia —
reducción TP velocidad de flujo 8l/min azul tolerancia ±20%			

















			
1			
código	370019	referencia	33D0290
descripción	válvula magnética doble acodado 230VAC entrada 3/4" salida 11,5mm DN10 TP plástico		
repuestos para	370019		
	código	371013	referencia —
bobina magnética TP 230VAC 50/60Hz			
accesorios para	370019		
	código	371220	referencia —
reducción TP velocidad de flujo 3l/min rojo tolerancia ±15%			
	código	371221	referencia —
reducción TP velocidad de flujo 5.5l/min amarillo tolerancia ±15%			
	código	371222	referencia —
reducción TP velocidad de flujo 6l/min gris tolerancia ±15%			
	código	371223	referencia —
reducción TP velocidad de flujo 10l/min blanco tolerancia ±15%			
	código	371224	referencia —
reducción TP velocidad de flujo 12l/min bronce tolerancia ±15%			

















accesorios para		370019	
	código	371225	referencia —
reducción TP velocidad de flujo 16l/min marrón claro tolerancia ±15%			
	código	371226	referencia —
reducción TP velocidad de flujo 20l/min rojo tolerancia ±15%			
	código	371230	referencia —
reducción TP velocidad de flujo 0.25l/min rojo tolerancia ±25%			
	código	371231	referencia —
reducción TP velocidad de flujo 0.35l/min violeta tolerancia ±25%			
	código	371232	referencia —
reducción TP velocidad de flujo 0.5l/min naranja tolerancia ±25%			
	código	371233	referencia —
reducción TP velocidad de flujo 0.8l/min blanco tolerancia ±25%			
	código	371234	referencia —
reducción TP velocidad de flujo 1l/min azul claro tolerancia ±25%			
	código	371235	referencia —
reducción TP velocidad de flujo 1.2l/min marrón tolerancia ±25%			
	código	371236	referencia —
reducción TP velocidad de flujo 1.5l/min marrón claro tolerancia ±25%			
	código	371237	referencia —
reducción TP velocidad de flujo 2.5l/min amarillo tolerancia ±25%			
	código	371238	referencia —
reducción TP velocidad de flujo 3.4l/min verde oscuro tolerancia ±25%			
	código	371239	referencia —
reducción TP velocidad de flujo 5l/min negro tolerancia ±25%			
	código	371240	referencia —
reducción TP velocidad de flujo 8l/min azul tolerancia ±20%			

			
1			
código	370015	referencia	33D1370 33D1371
descripción	válvula magnética simple acodado 230VAC entrada 3/4" salida 11,5mm DN10 TP		
accesorios para	370015		
	código	371220	referencia —
reducción TP velocidad de flujo 3l/min rojo tolerancia ±15%			
	código	371221	referencia —
reducción TP velocidad de flujo 5.5l/min amarillo tolerancia ±15%			

Continúa en la página siguiente





accesorios para	370015			
	código	371222	referencia	—
	reducción TP velocidad de flujo 6l/min gris tolerancia ±15%			
	código	371223	referencia	—
	reducción TP velocidad de flujo 10l/min blanco tolerancia ±15%			
	código	371224	referencia	—
	reducción TP velocidad de flujo 12l/min bronce tolerancia ±15%			
	código	371225	referencia	—
	reducción TP velocidad de flujo 16l/min marrón claro tolerancia ±15%			
	código	371226	referencia	—
	reducción TP velocidad de flujo 20l/min rojo tolerancia ±15%			
	código	371230	referencia	—
	reducción TP velocidad de flujo 0.25l/min rojo tolerancia ±25%			
	código	371231	referencia	—
	reducción TP velocidad de flujo 0.35l/min violeta tolerancia ±25%			
	código	371232	referencia	—
	reducción TP velocidad de flujo 0.5l/min naranja tolerancia ±25%			
	código	371233	referencia	—
	reducción TP velocidad de flujo 0.8l/min blanco tolerancia ±25%			
	código	371234	referencia	—
	reducción TP velocidad de flujo 1l/min azul claro tolerancia ±25%			
	código	371235	referencia	—
	reducción TP velocidad de flujo 1.2l/min marrón tolerancia ±25%			
	código	371236	referencia	—
	reducción TP velocidad de flujo 1.5l/min marrón claro tolerancia ±25%			
	código	371237	referencia	—
	reducción TP velocidad de flujo 2.5l/min amarillo tolerancia ±25%			
	código	371238	referencia	—
	reducción TP velocidad de flujo 3.4l/min verde oscuro tolerancia ±25%			
	código	371239	referencia	—
	reducción TP velocidad de flujo 5l/min negro tolerancia ±25%			
	código	371240	referencia	—
	reducción TP velocidad de flujo 8l/min azul tolerancia ±20%			

				
1				
código	370031	referencia	N/A	
descripción	válvula magnética simple acodado 24VAC entrada 3/4" salida 14mm DN10 TP			
repuestos para	370031			
	código	371035	referencia	—
	bobina magnética 24VAC			
accesorios para	370031			
	código	371220	referencia	—
	reducción TP velocidad de flujo 3l/min rojo tolerancia ±15%			
	código	371221	referencia	—
	reducción TP velocidad de flujo 5.5l/min amarillo tolerancia ±15%			
	código	371222	referencia	—
	reducción TP velocidad de flujo 6l/min gris tolerancia ±15%			
	código	371223	referencia	—
	reducción TP velocidad de flujo 10l/min blanco tolerancia ±15%			
	código	371224	referencia	—
	reducción TP velocidad de flujo 12l/min bronce tolerancia ±15%			
	código	371225	referencia	—
	reducción TP velocidad de flujo 16l/min marrón claro tolerancia ±15%			
	código	371226	referencia	—
	reducción TP velocidad de flujo 20l/min rojo tolerancia ±15%			
	código	371230	referencia	—
	reducción TP velocidad de flujo 0.25l/min rojo tolerancia ±25%			
	código	371231	referencia	—
	reducción TP velocidad de flujo 0.35l/min violeta tolerancia ±25%			
	código	371232	referencia	—
	reducción TP velocidad de flujo 0.5l/min naranja tolerancia ±25%			
	código	371233	referencia	—
	reducción TP velocidad de flujo 0.8l/min blanco tolerancia ±25%			
	código	371234	referencia	—
	reducción TP velocidad de flujo 1l/min azul claro tolerancia ±25%			
	código	371235	referencia	—
	reducción TP velocidad de flujo 1.2l/min marrón tolerancia ±25%			
	código	371236	referencia	—
	reducción TP velocidad de flujo 1.5l/min marrón claro tolerancia ±25%			
	código	371237	referencia	—
	reducción TP velocidad de flujo 2.5l/min amarillo tolerancia ±25%			

Continúa en la página siguiente



accesorios para	370031		
	código	371238	referencia —
	reducción TP velocidad de flujo 3.4l/min verde oscuro tolerancia ±25%		
	código	371239	referencia —
	reducción TP velocidad de flujo 5l/min negro tolerancia ±25%		
	código	371240	referencia —
	reducción TP velocidad de flujo 8l/min azul tolerancia ±20%		

válvulas magnéticas con reducciones



código	370648	referencia	3032670
descripción	válvula magnética doble recto 220-240VAC entrada 3/4" reducción entrada A 10l/min DN10 TP salida 11.5mm reducción salida A 3.4l/min reducción salida A verde		
Para modelos:	10CP1EA, 10CP1GA, 10CP1IA, 12CP1EA, 12CP1GA, 12CP1IA, 18CP2EA, 18CP2GA, 18CP2IA, FC1011E, FC1011G, FC1221E, FC1221G, FC611E, FC611G, FM1011E2-VERS.2006, FM1011E3, FM1011E3-VERS.2006, FM1011G2-VERS.2006, FM1011G3, FM1011G3-VERS.2006, FM1221E2-VERS.2006, FM1221E3, FM1221E3-VERS.2006, FM1221G2-VERS.2006, FM1221G3, FM1221G3-VERS.2006, FM2011E2-VERS.2006, FM2011E3-VERS.2006, FM2011G2-VERS.2006, FM2011G3-VERS.2006, FM2021E1, FM2021E2, FM2021E2-VERS.2006, FM2021E3, FM2021E3-VERS.2006, FM2021G1, FM2021G2, FM2021G2-VERS.2006, FM2021G3, FM2021G3-VERS.2006, FM423E2, FM611E2-VERS.2006, FM611E3, FM611E3-VERS.2006, FM611G2-VERS.2006, FM611G3, FM611G3-VERS.2006, FM721E1-VERS.2006, FM721E2-VERS.2006...(Otros modelos se puede ver en la tienda web)		

metal





ASCO

recambios y accesorios

enchufe



código	371093	referencia	32A2330
descripción	enchufe tipo de conector compacto longitud del cable 1100mm pequeño		
Para modelos:	0A1FR1G, 0A1FR1GD, 0A1FR1GD-VERS.2004, 0A1FR1G-VERS.2004, 0B1FR1G, 0B1FR1GD, 0D1FR1G, 0D1FR1GD, 0D1FR1GD-VERS.2004, 0D1FR1G-VERS.2004, 1A1BR1G, 1A1BR1GA, 1A1BR2G, 1A1BR2GA, 1A1FR2G, 1A1FR2GD, 1A1FR2GD-VERS.2004, 1A1FR2G-VERS.2004, 1D1BR1G, 1D1BR1GA, 1D1BR2G, 1D1BR2GA, 1D1FR2G, 1D1FR2GD, 1D1FR2GD-VERS.2004, 1D1FR2G-VERS.2004, 2A1BR1G, 2A1BR1GA, 2A1BR2G, 2A1BR2GA, 2D1BR1G, 2D1BR1GA, 2D1BR2G, 2D1BR2GA		

SIRAI			
2 vías			
serie L140-B			
			
código	370320	referencia	33D1060
descripción	válvula magnética latón 2vías 24VAC entrada 1/2" salida 1/2" empalme 1/2" L 41 mm DN 10mm conector hembra compacto -10 a +90°C SIRAI serie L140-B tipo de bobina Z610A membrana NBR (Wasser) p máx. 12bar p mín. 0.35bar		
Para modelos:	C165D, C165S, C207D, C207D-VERS.2006, C207S, C207S-VERS.2006, C207VD, C207VD-VERS.2006, C207VS, C207VS-VERS.2006, C304AD, C304AD-VERS.2006, C304AS, C304AS-VERS.2006, C304AVD, C304AVD-VERS.2006, C304AVS, C304AVS-VERS.2006, C304D, C304D-VERS.2006, C304S, C304S-VERS.2006, C304VD, C304VD-VERS.2006, C304VS, C304VS-VERS.2006, C92D-VERS.2006, C92S-VERS.2006, C92VD-VERS.2006, C92VS-VERS.2006, CS243D, CS243D-VERS.2006, CS243S, CS243S-VERS.2006, CS243VD, CS243VD-VERS.2006, CS243VS, CS243VS-VERS.2006, CS370AD, CS370AD-VERS.2006, CS370AS, CS370AS-VERS.2006, CS370AVD, CS370AVD-VERS.2006, CS370AVS, CS370AVS-VERS.2006, CS370D, CS370D-VERS.2006, CS370S, CS370S-VERS.2006...(Otros modelos se puede ver en la tienda web)		
repuestos para	370320		
	código	371070	referencia N/A
	bobina magnética 24VAC 10VA SIRAI tipo de bobina Z610A soporte ø 10mm		
	código	371163	referencia N/A
	membrana empalme 1/2" serie L140-B tipo de membrana NBR (Wasser)		
accesorios para	370320		
	código	371091	referencia N/A
	enchufe tipo de conector DIN 43650B longitud del cable mm pequeño		



serie L180-B



1

código	370391	referencia	33D1050	
descripción	válvula magnética 2vías 24VAC empalme 3/4" L 79mm DN 18mm -10 a +90°C tipo de bobina Z610A membrana NBR (Wasser) p máx. 12bar p mín. 0.35bar			
Para modelos:	C165D, C165S, C207D, C207D-VERS.2006, C207S, C207S-VERS.2006, C207VD-VERS.2006, C207VS-VERS.2006, C304AD, C304AD-VERS.2006, C304AS, C304AS-VERS.2006, C304AVD-VERS.2006, C304AVS-VERS.2006, C304D, C304D-VERS.2006, C304S, C304S-VERS.2006, C304VD-VERS.2006, C304VS-VERS.2006, C92D-VERS.2006, C92S-VERS.2006, C92VD-VERS.2006, C92VS-VERS.2006, CS243D, CS243D-VERS.2006, CS243S, CS243S-VERS.2006, CS243VD, CS243VD-VERS.2006, CS243VS, CS243VS-VERS.2006, CS370AD, CS370AD-VERS.2006, CS370AS, CS370AS-VERS.2006, CS370AVD, CS370AVD-VERS.2006, CS370AVS, CS370AVS-VERS.2006, CS370D, CS370D-VERS.2006, CS370S, CS370S-VERS.2006, CS370VD, CS370VD-VERS.2006, CS370VS, CS370VS-VERS.2006, CS466AD, CS466AD-VERS.2006...(Otros modelos se puede ver en la tienda web)			
accesorios para	370391			
	código	371091	referencia	N/A
	enchufe tipo de conector DIN 43650B longitud del cable mm pequeño			



1

código	370329	referencia	N/A	
descripción	válvula magnética 2vías 24VAC entrada 1/2" salida 1/2" empalme 1/2" L 66mm DN 13.5mm conector hembra compacto -10 a +90°C SIRAI serie L180-B tipo de bobina Z610A membrana NBR (Wasser) p máx. 12bar p mín. 0.35bar			
repuestos para	370329			
	código	371070	referencia	N/A
	bobina magnética 24VAC 10VA SIRAI tipo de bobina Z610A soporte ø 10mm			
	código	371171	referencia	N/A
	membrana serie L180-B tipo de membrana NBR (Wasser)			
accesorios para	370329			
	código	371091	referencia	N/A
	enchufe tipo de conector DIN 43650B longitud del cable mm pequeño			



1

código	370047	referencia	33D0070 33D1460	
descripción	válvula magnética latón 2vías 230VAC entrada 1/2" salida 1/2" empalme 1/2" L 66mm DN 13.5mm conector hembra compacto -10 a +90°C SIRAI serie L180-B tipo de bobina Z610A membrana NBR (Wasser) p máx. 12bar p mín. 0.35bar 50/60Hz			
repuestos para	370047			
	código	371085	referencia	—
	bobina magnética 230VAC 4VA SIRAI tipo de bobina ZB10A soporte ø 10mm 50/60Hz			
	código	371171	referencia	N/A
	membrana serie L180-B tipo de membrana NBR (Wasser)			
accesorios para	370047			
	código	371091	referencia	N/A
	enchufe tipo de conector DIN 43650B longitud del cable mm pequeño			

válvulas magnéticas vapor (agua)

2 vías



serie L145-R



1

código	370085	referencia	33D1420	
descripción	válvula magnética 230VAC empalme 1" L 105mm DN 18.5mm conector hembra DIN -60 a +170°C SIRAI serie L145-R tipo de bobina Z534A membrana PTFE (vapor) p máx. 8bar p mín. 0.4bar			
repuestos para	370085			
	código	371067	referencia	N/A
	bobina magnética 230VAC 14VA SIRAI tipo de bobina Z534A soporte ø 12mm			
	código	371166	referencia	—
	membrana empalme 1" serie L145-R tipo de membrana PTFE			
accesorios para	370085			
	código	371090	referencia	N/A
	enchufe tipo de conector DIN 43650A atornillado			



código	370318	referencia	33D0570
descripción	válvula magnética 2vías 24VAC entrada 1/2" salida 1/2" empalme 1/2" L 66mm DN 10mm conector hembra compacto -60 a +170°C SIRAI serie L145-R tipo de bobina Z614A membrana PTFE (vapor) p máx. 8bar p mín. 0.4bar		
repuestos para	370318		
	código	371158	referencia N/A
	bobina magnética 24VAC 10VA SIRAI tipo de bobina Z614A soporte ø 10mm		
	código	371164	referencia N/A
	membrana empalme 3/8"-1/2" serie L145-R tipo de membrana PTFE		
accesorios para	370318		
	código	371091	referencia N/A
	enchufe tipo de conector DIN 43650B longitud del cable mm pequeño		

serie L153-D



código	370326	referencia	33D0560
descripción	válvula magnética 2vías 230VAC empalme 1" L 105mm DN 22mm conector hembra DIN -10 a 140°C SIRAI serie L153-D tipo de bobina Z914A membrana EPDM (vapor/agua) p máx. 8bar p mín. 0.1bar		
repuestos para	370326		
	código	371161	referencia N/A
	bobina magnética 230VAC 27VA SIRAI tipo de bobina Z923A soporte ø 16mm 50Hz		

recambios y accesorios

solenoides



código	371071	referencia	32Z5470
descripción	bobina magnética 230VAC 10VA SIRAI tipo de bobina Z610A soporte ø 10mm H 33mm L 33mm An 25mm 50/60Hz		
accesorios para	371071		
	código	371091	referencia N/A
	enchufe tipo de conector DIN 43650B longitud del cable mm pequeño		



código	371067	referencia	N/A
descripción	bobina magnética 230VAC 14VA SIRAI tipo de bobina Z534A soporte ø 12mm		



código	371161	referencia	N/A
descripción	bobina magnética 230VAC 27VA SIRAI tipo de bobina Z923A soporte ø 16mm 50Hz		



código	371070	referencia	N/A
descripción	bobina magnética 24VAC 10VA SIRAI tipo de bobina Z610A soporte ø 10mm		
accesorios para	371070		



código	371091	referencia	N/A
	enchufe tipo de conector DIN 43650B longitud del cable mm pequeño		



código	371158	referencia	N/A
descripción	bobina magnética 24VAC 10VA SIRAI tipo de bobina Z614A soporte ø 10mm		
accesorios para	371158		



código	371091	referencia	N/A
	enchufe tipo de conector DIN 43650B longitud del cable mm pequeño		



código	371099	referencia	N/A
descripción	bobina magnética 24VDC 5.5VA SIRAI tipo de bobina ZB10A soporte ø 10mm		
accesorios para	371099		



código	371091	referencia	N/A
	enchufe tipo de conector DIN 43650B longitud del cable mm pequeño		



membranas

1 

código	371163	referencia	N/A
descripción	membrana empalme 1/2" serie L140-B tipo de membrana NBR (Wasser)		

1 

código	371172	referencia	N/A
descripción	membrana empalme 3/4" serie L180-B tipo de membrana NBR (Wasser)		

1 

código	371164	referencia	N/A
descripción	membrana empalme 3/8"-1/2" serie L145-R tipo de membrana PTFE		

1 

código	371170	referencia	N/A
descripción	membrana serie L180-B tipo de membrana NBR (Wasser)		

1 

código	371171	referencia	N/A
descripción	membrana serie L180-B tipo de membrana NBR (Wasser)		

válvulas magnéticas gas

BRAHMA
válvulas magnéticas

1 

código	101948 ¹	referencia	33A1650	
descripción	válvula magnética 230VAC DN 15mm empalme 1/2" L 72mm BRAHMA tipo de bobina 18811003 p máx. 0.5bar N° reg. CE 63AQ0626			
Para modelos:	1A1PI2G, 1A1PI2GA, 1D1PI2G, 1D1PI2GA, 291PI3G, 2A1PI3G, 2D1PI3G			
repuestos para	101948			
	código	101968	referencia	—
	válvula magnética 230VAC 20VA soporte ø 17mm tipo de bobina 13902001 BRAHMA			

¹carcasa de aluminio

recambios y accesorios

solenoides

1 

código	106242	referencia	32V3640
descripción	bobina magnética 230VAC 20VA soporte ø 17mm		
Para modelos:	1A1PI2G, 1A1PI2GA, 1D1PI2G, 1D1PI2GA, 291PI3G, 2A1PI3G, 2D1PI3G		

válvulas magnéticas refrigeración

CASTEL
recambios y accesorios

1 

código	371090	referencia	N/A
descripción	enchufe tipo de conector DIN 43650A atornillado		



PARKER

válvulas



1	código	370611	referencia	33A0510
	descripción	válvula magnética 2 vías 230V 1.9 tubo ø6mm tipo de bobina ZB09 50/60Hz		
	Para modelos:	120, 120NN, 120PV, 135, 135-4, 135BN, 135BNX, 135CPX, 135NN, 135NNX, 135PVX, 135X, 135X-3, 135X-4, 40CP, 40CPX, 55, 55PV, 65, 65NB, 65NBX, 65NN, 65NNX, 65PVX, 65X, 65X-2, 6BEA11A, 6BEA11B, 6BEA11M, 6BEA11Z, 6BEA2A, 6BEA2B, 6BEA2M, 6BEA2Z, 6BEA3A, 6BEA3B, 6BEA3M, 6BEA3Z, 6BEAA, 6BEAB, 6BEAM, 6BEAZ, 6BEB11A, 6BEB11B, 6BEB11M, 6BEB11Z, 6BEB22A, 6BEB22B, 6BEB22M, 6BEB22Z...(Otros modelos se puede ver en la tienda web)		

Válvulas magnéticas - accesorios

filtros

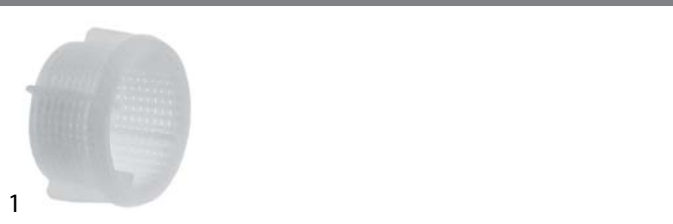

1	código	370467	referencia	N/A
	descripción	filtro de válvula magnética apto para ELBI		



1	código	371091	referencia	N/A
	descripción	enchufe tipo de conector DIN 43650B longitud del cable mm pequeño		

presostatos

para sistemas de lavado

ø58mm con conector Faston 6,3mm

con empalme horizontal



1	código	541192	referencia	32Z7190
	descripción	presostato		
	Para modelos:	LT10R, LT20F, LT25F		



1	código	541017	referencia	32Z8930
	descripción	presostato con abrazadera de montaje margen de presión 40/20mbar empalme 6mm ø 58mm conexión de presión horizontal sistemas de lavado		
	Para modelos:	CS243S, CS243VS, CS370AS, CS370AVS, CS370S, CS370VS, CS466AS, CS466AVS, CS466VS, LF50, LF50E, LF50EM, LF50E-VERS.2007, N303D, N303S, N303VD, N303VS, N354D, N354S, N354VD, N354VS, N506D, N506S, N506VD, N506VS, N607D, N607S, N607VD, N607VS, N760D, N760S, N760VD, N760VS, N886D, N886S, N886VD, N886VS		



1	código	541011	referencia	32Z4690
	descripción	presostato margen de presión 110/70mbar empalme 6mm ø 58mm conexión de presión horizontal sistemas de lavado		



1	código	541331	referencia	32Z0860
	descripción	presostato margen de presión 225/70mbar empalme 6mm ø 58mm conexión de presión horizontal sistemas de lavado		
	Para modelos:	L100, L80, LCV		

1

código	541314	referencia	32V7060
descripción	presostato margen de presión 46/26mbar empalme 6mm ø 58mm conexión de presión horizontal sistemas de lavado empalme presión ø 6mm		
Para modelos:	KD100, KD100A, KD100PSD, KD130A, KD130E, KD130EAT, KD37, KD37PS, KD37-VERS.112009, KD40, KD40EPSD, KD40LEPS, KD40LSPS, KD40LUX, KD40LUXE, KD40PS, KD40-VERS.112009, KD60, KD60E, KD60EAT, KD60M, KD60MA, KD60ME, KD60MPS, KD60MPSA, KD60PS, KD60PSD, KD6EATSD, KD85A, KD85EA, KD85EAT, KD85EATS, KD85EPSA, KD85PSA, KN1100, KN1100SD, KN11PSDD, KN35, KN37, KN37PS, KN40, KN40PS, KN40PSD, KN50, KN50M, KN50MPS, KN50PS, KN50PSD, KN50PSDD, KN80...(Otros modelos se puede ver en la tienda web)		



1

código	541330	referencia	32Z4740 32Z4741
descripción	presostato margen de presión 70/30mbar empalme 6mm ø 58mm conexión de presión horizontal sistemas de lavado empalme presión ø 6mm		
Para modelos:	F60P, F60PR, F60T, F80P, F80PR, L40, L40S, L45, L60, LCV		



1

código	541010	referencia	32Z4700
descripción	presostato margen de presión 50/30mbar empalme 6mm ø 58mm conexión de presión horizontal sistemas de lavado		



1

código	541311	referencia	32Z0070
descripción	presostato margen de presión 76/38mbar empalme 6mm ø 58mm conexión de presión horizontal sistemas de lavado empalme presión ø 6mm		



1

código	541194	referencia	32Z2170
descripción	presostato margen de presión 50/32mbar empalme conector Faston 6,3mm ø 58mm conexión de presión horizontal sistemas de lavado empalme presión ø 6mm		



1

código	541312	referencia	32V7080
descripción	presostato margen de presión 86/59mbar empalme 6mm ø 58mm conexión de presión horizontal sistemas de lavado empalme presión ø 6mm		
Para modelos:	KD100, KD100A, KD100PSD, KD40EPSD, KD40LEPS, KD40LUXE, LP151		



1

código	541140	referencia	32V7060 32Z2170
descripción	presostato margen de presión 55/30mbar empalme 6mm ø 58mm conexión de presión horizontal sistemas de lavado		



1

código	541168	referencia	32V1870 32Z8880
descripción	presostato margen de presión 90/35mbar empalme 6mm ø 58mm conexión de presión horizontal sistemas de lavado empalme presión ø 6mm		
Para modelos:	C165D, C165S, C165VD, C165VS, C207D, C207S, C207VD, C207V-VERS.2006, C207VS, C207VS-VERS.2006, C304AD, C304AS, C304AVD, C304AVD-VERS.2006, C304AVS, C304AVS-VERS.2006, C304D, C304S, C304VD, C304VD-VERS.2006, C304VS, C304VS-VERS.2006, C92VD-VERS.2006, C92VS-VERS.2006, LC100, LC100-VERS.2001, LC130, LC130-VERS.2001, LC80, N303S, N303VD, N303VS, N354D, N354VD, N354VS, N506D, N506VD, N506VS, N607D, N607VD, N607VS, N760S, N760VD, N760VS, N886D, N886VD, N886VS		



1

código	541012	referencia	32Z0280
descripción	presostato margen de presión 68/40mbar empalme 6mm ø 58mm conexión de presión horizontal sistemas de lavado empalme presión ø 6mm		



			
1			
código	541199	referencia	6300569
descripción	presostato margen de presión 0,2-3,0mbar ø 74mm empalme presión ø 6.3mm		
Para modelos:	FC1011G, FC1221G, FC611G, FM1011G1, FM1011G1-VERS.2006, FM1011G2, FM1011G2-VERS.2006, FM1011G3, FM1011G3-VERS.2006, FM1221G1, FM1221G1-VERS.2006, FM1221G2, FM1221G2-VERS.2006, FM1221G3, FM1221G3-VERS.2006, FM2011G2-VERS.2006, FM2011G3-VERS.2006, FM2021G1, FM2021G2, FM2021G2-VERS.2006, FM2021G3, FM2021G3-VERS.2006, FM611G1, FM611G1-VERS.2006, FM611G2, FM611G2-VERS.2006, FM611G3, FM611G3-VERS.2006, FM721G1, FM721G1-VERS.2006, FM721G2, FM721G2-VERS.2006, FM721G3, FM721G3-VERS.2006		

ø79mm con conector codificado

			
1			
código	541332	referencia	32Z2840
descripción	presostato 2 márgenes de presión margen de presión 70/40 90/70mbar empalme conector codificado ø 78mm conexión de presión horizontal sistemas de lavado empalme presión ø 6mm a 250 V 16A		
Para modelos:	F60PR, F60T, F80P, F80PR		

para hornos a vapor combinado

			
1			
código	541806	referencia	3041830 32Z5870 32Z5871 32Z5872
descripción	presostato ø 38mm margen de presión 0,2-3,0bar empalme 1/8" 250V 10A GP600 empalme de presión 1/8"		
Para modelos:	BX101E, BX101E-VERS.122013, BX101G, BX101G-VERS.122013, BX122E, BX122E-VERS.122013, BX122G, BX122G-VERS.122013, BX61E, BX61E-VERS.122013, BX61G, BX61G-VERS.122013, BX82E, BX82E-VERS.122013, BX82G, BX82G-VERS.122013, FCV101, FCV101-CSA, FCV101DM, FCV101DM-CSA, FCV101DS, FCV101DS-CSA, FCV101E, FCV101EDM, FCV101EDM-CSA, FCV101EDS, FCV101EDS-CSA, FCV101E-UL, FCV101E-UL-CSA, FCV101EDM, FCV101EDM-CSA, FCV101EDS, FCV101EDS-CSA, FCV101E-UL, FCV101E-UL-CSA, FCV101EDM, FCV101EDM-CSA, FCV101EDS, FCV101EDS-CSA, FCV241, FCV241DM, FCV241DS, FCV241E, FCV241EDM, FCV241EDM-UL, FCV241EDS, FCV241EDS-UL, FCV241E-UL, FCV241G, FCV241G-CSA, FCV241GDM, FCV241GDM-CSA...(Otros modelos se puede ver en la tienda web)		
accesorios para	541806		
	código	541814	referencia —
tapa de protección para presóstato EPDM XP600			

			
1			
código	541575	referencia	3004460 3004461
descripción	presostato ø 45.5mm margen de presión 400/200mbar 1CO conexión de presión vertical vaporizador combinado empalme conector Faston 6,3mm apto para ANGELO PO 250V p máx. 1bar 6A empalme de presión 1/8"		
Para modelos:	FM1011E3, FM1011E3-VERS.2006, FM1011G3, FM1011G3-VERS.2006, FM1221E3, FM1221E3-VERS.2006, FM1221G3, FM1221G3-VERS.2006, FM2011E3-VERS.2006, FM2011G3-VERS.2006, FM2021E3, FM2021E3-VERS.2006, FM2021G3, FM2021G3-VERS.2006, FM611E3, FM611E3-VERS.2006, FM611G3, FM611G3-VERS.2006, FM721E3, FM721E3-VERS.2006, FM721G3, FM721G3-VERS.2006		

para cuecepastas

			
1			
código	541980	referencia	6300988
descripción	kit de modificación para bomba de desagüe margen de presión 300/245 385/300bar 0G1CP1G		

			
1			
código	542229	referencia	3160100 3253760
descripción	presostato margen de presión 350/265mbar empalme 5.5		
Para modelos:	04WCP1EM, 06WCP1GM, 08WCP1GM, 091CP1E, 091CP1G, 191CP1G, 191CP2G, 1G1CP1G-VERS.2004, 6040090, 6040310		

			
1			
código	541482	referencia	3017600
descripción	presostato margen de presión 385/325mbar empalme 6mm		
Para modelos:	04WCP1EM, 06WCP1GM, 08WCP1GM, 091CP1E, 091CP1G, 0G1CP1EC, 0G1CP1E-VERS.2004, 0G1CP1G-VERS.2004, 191CP1G, 191CP2G, 1G1CP1G-VERS.2004, 1G1CP2G-VERS.2004		



para marmitas



1

código	541510	referencia	32V1790
descripción	presostato EGO		
Para modelos:	1A1PI2G, 1A1PI2GA, 1D1PI2G, 1D1PI2GA, 291PI3E, 291PI3G, 2A1PI3E, 2A1PI3G, 2D1PI3G, MCF20E, MCF20V, MCF40E, MCF40V		

para refrigeración

RANCO

serie G60



1

código	541195	referencia	32Z6350
descripción	presostato RANCO G60H1129401		
Para modelos:	120NN, 65NB, 65NBX, 65NN, 65NNX, SP65NB, SP65NN		

compresores

ACC/ZEL

R134a

HMBP monofásico

Temperatura alta/media de evaporación superior a -20/-15 °C



1

código	605007	referencia	34D6390
descripción	compresor refrigerante R134a tipo GL60TB 220-240V 50Hz HMBP completamente hermético 9.5kg 1/5HP consumo 437W capacidad cilindro 5.7 cm ³ CSIR H 175.5mm 95W 128W 170W 222W 284W 355W 437W 528W metodo de test ASHRAE temperatura ambiente máx. 43°C		
Para modelos:	40CP, 40CPX, 65A, 65XE, 6FMA11A, 6FMA11B, 6FMA11M, 6FMA11Z, 6FMA2A, 6FMA2B, 6FMA2M, 6FMA2Z, 6FMA4A, 6FMA4B, 6FMA4M, 6FMA4Z, 6FMAA, 6FMAB, 6FMAM, 6FMAZ, 6TRA, 6TRA2, 6TRA2A, 6TRA2M, 6TRA2Z, 6TRA4, 6TRA4A, 6TRA4M, 6TRA4Z, 6TRAA, 6TRAM, 6TRAZ, CX140CP, CX150CP, CX65NB, CX65NCP, CX65NN, CX70NB, CX70NN, FM1A, FM1A-11, FM1A-2, FM1A-4, S60, S60-2, S60E, S60X, S60X-2, SA87		



código	605008	referencia	34D6500
descripción	compresor refrigerante R134a tipo GL80TB 220-240V 50Hz HMBP completamente hermético 9.5kg 1/5HP consumo 554W capacidad cilindro 7.6 cm ³ CSIR H 175.5mm 165W 215W 290W 390W 500W 615W 727W 840W metodo de test ASHRAE temperatura ambiente máx. 43°C		
Para modelos:	55, 55PV, 6JB, 6JB2, 6JB2A, 6JB2M, 6JB4A, 6JB4M, 6JBA, 6JBM, 6SMB, 6SMB2, 6SMB2A, 6SMB2B, 6SMB2M, 6SMB2Z, 6SMB4, 6SMB4A, 6SMB4B, 6SMB4M, 6SMB4Z, 6SMB6Z, 6SMB6A, 6SMB6B, 6SMB6M, 6SMB6Z, PE1633, PE1633V, PZ20, PZ2033A, PZ2033B, PZ2037A, PZ2037B		



código	605009	referencia	34D6510
descripción	compresor refrigerante R134a tipo GL90TB 220-240V 50Hz HMBP completamente hermético 10.8kg 1/4HP consumo 293W capacidad cilindro 8.8 cm ³ CSIR H 175.5mmW 143W 194W 259W 339W 432W 539W 661W 796W metodo de test ASHRAE		
Para modelos:	6FMB11A, 6FMB11B, 6FMB11M, 6FMB11Z, 6FMB2A, 6FMB2B, 6FMB2M, 6FMB2Z, 6FMB4A, 6FMB4B, 6FMB4M, 6FMB4Z, 6FMB6A, 6FMB6B, 6FMB6M, 6FMB6Z, 6FMC11A, 6FMC11B, 6FMC11M, 6FMC11Z, 6FMC2A, 6FMC2B, 6FMC2M, 6FMC2Z, 6FMC4A, 6FMC4B, 6FMC4M, 6FMC4Z, 6FMCA, 6FMCB, 6FMCM, 6FM CZ, 6TRB, 6TRB11, 6TRB11A, 6TRB11M, 6TRB11Z, 6TRB2, 6TRB2A, 6TRB2M, 6TRB2Z, 6TRB4, 6TRB4A, 6TRB4M, 6TRB4Z, 6TRB6, 6TRB6A, 6TRB6M, 6TRB6Z, 6TRBA...(Otros modelos se puede ver en la tienda web)		



1

código	605010	referencia	34D6520 34D6760
descripción	compresor refrigerante R134a tipo GP12TB 220-240V 50Hz HMBP completamente hermético 11.2kg 3/8HP consumo 661W capacidad cilindro 12 cm ³ CSIR H 203.6mmW 143W 194W 259W 339W 432W 539W 661W 796W metodo de test ASHRAE temperatura ambiente máx. 43°C		
Para modelos:	120, 120NN, 120PV, 135, 135-4, 135A, 135NN, 135NNX, 135PVX, 135X, 135X-3, 135X-4, 135XE, 65NN, 65NNX, 65PVX, 6SMC, 6SMC2, 6SMC2A, 6SMC2B, 6SMC2M, 6SMC2Z, 6SMC4, 6SMC4A, 6SMC4B, 6SMC4M, 6SMC4Z, 6SMC6, 6SMC6A, 6SMC6B, 6SMC6M, 6SMC6Z, 6SMC8Z, 6SMCA, 6SMCB, 6SMCM, 6SMCZ, 6TRC, 6TRC11, 6TRC11A, 6TRC11M, 6TRC11Z, 6TRC2, 6TRC2A, 6TRC2M, 6TRC2Z, 6TRC4, 6TRC4A, 6TRC4M, 6TRC4Z...(Otros modelos se puede ver en la tienda web)		

CUBIGEL

accesorios



1

código	380091	referencia	32Z6920
descripción	relé de arranque MTRP0027 120/240V tensión AC 8A 1NO		
Para modelos:	135CPX, 55, 55PV, 6BEA11A, 6BEA11B, 6BEA11M, 6BEA2A, 6BEA2B, 6BEA2M, 6BEA3A, 6BEA3B, 6BEA3M, 6BEAA, 6BEAB, 6BEAM, 6BEB11A, 6BEB11B, 6BEB11M, 6BEB22A, 6BEB22B, 6BEB22M, 6BEB2A, 6BEB2B, 6BEB2M, 6BEB3A, 6BEB3B, 6BEB3M, 6BEB4A, 6BEB4B, 6BEB4M, 6BEBA, 6BEBA, 6BEBA, 6BMA11A, 6BMA11B, 6BMA11M, 6BMA2A, 6BMA2B, 6BMA2M, 6BMA3A, 6BMA3B, 6BMA3M, 6BMAA, 6BMAB, 6BMAM, 6FMA11A, 6FMA11B, 6FMA11M, 6FMA2A, 6FMA2B...(Otros modelos se puede ver en la tienda web)		

EMBRACO / ASPERA

R134A

HBP monofásico

Temperatura alta de evaporación superior a -15°C



1

código	605209	referencia	34D5490
descripción	compresor refrigerante R134a tipo NEK6187Z-A 220-240V 50Hz HBP 11kg 1/3HP capacidad cilindro 10 cm ³ CSIR H 200mmWWW 365W 482W 624W 791W 983W 1201W metodo de test EN 12900 temperatura ambiente máx. 55°C		
Para modelos:	6BEC11A, 6BEC11B, 6BEC11M, 6BEC11Z, 6BEC22A, 6BEC22B, 6BEC22M, 6BEC22Z, 6BEC2A, 6BEC2B, 6BEC2M, 6BEC2Z, 6BEC33A, 6BEC33B, 6BEC33M, 6BEC33Z, 6BEC3A, 6BEC3B, 6BEC3M, 6BEC3Z, 6BEC4A, 6BEC4B, 6BEC4M, 6BEC4Z, 6BEC6A, 6BEC6B, 6BEC6M, 6BEC6Z, 6BECA, 6BECB, 6BECM, 6BECZ, 6BMB11A, 6BMB11B, 6BMB11M, 6BMB11Z, 6BMB22A, 6BMB22B, 6BMB22M, 6BMB22Z, 6BMB2A, 6BMB2B, 6BMB2M, 6BMB2Z, 6BMB3A, 6BMB3B, 6BMB3M, 6BMB3Z, 6BMB4A, 6BMB4B...(Otros modelos se puede ver en la tienda web)		

accesorios

relé de arranque

Klixons



1

código	380094	referencia	32Z1050
descripción	relé de arranque 120/240V tensión AC 8A 1NO 1NO 1 polos		

interrupor térmico (klixon)



1



código	390597	referencia	32Z1030
descripción	interrupor térmico para protección de motor térmica MRP77A-MN_3001 con cable T máx 150°C reinicio automático		



			
1			
código	390599	referencia	32Z6930
descripción	interruptor térmico para protección de motor térmica T0318/22 con cable T máx 150°C reinicio automático		
Para modelos:	135CPX, 55, 55PV, 6BEA11A, 6BEA11B, 6BEA11M, 6BEA2A, 6BEA2B, 6BEA2M, 6BEA3A, 6BEA3B, 6BEA3M, 6BEAA, 6BEAB, 6BEAM, 6BEB11A, 6BEB11B, 6BEB11M, 6BEB22A, 6BEB22B, 6BEB22M, 6BEB2A, 6BEB2B, 6BEB2M, 6BEB3A, 6BEB3B, 6BEB3M, 6BEB4A, 6BEB4B, 6BEB4M, 6BEBA, 6BEBB, 6BEBM, 6BMA11A, 6BMA11B, 6BMA11M, 6BMA2A, 6BMA2B, 6BMA2M, 6BMA3A, 6BMA3B, 6BMA3M, 6BMAA, 6BMAB, 6BMAM, 6FMA11A, 6FMA11B, 6FMA11M, 6FMA2A, 6FMA2B...(Otros modelos se puede ver en la tienda web)		

bandejas de agua condensada y cubetas de evaporación

cubetas de evaporación con resistencia

universal			
cartuchos calentadores			
			
1			
código	418892	referencia	32G3310
descripción	cartucho calentador 300W 230V ø 12mm L 240mm rosca 3/8" longitud del cable 2000mm resistencia de inmersión		
Para modelos:	AF1N, AF1N-OPR01, AF2N, AF2N-OPR01, CX120, CX120NN, CX130, CX130NN, CX140, CX140BN, CX140BR, CX140CP, CX140NN, CX140PV, CX140R, CX150, CX150BN, CX150BR, CX150CP, CX150NN, CX150PV, CX150R, CX55, CX60, CX65, CX652, CX65BR, CX65NB, CX65NCP, CX65NN, CX65PV, CX65R, CX70, CX702, CX70BR, CX70NB, CX70NN, CX70PV, CX70R, FSD1N, FSD2N, FSD2N2, FSDR1B-OPR01, FSDR1N-OPR01, FSDR2B-OPR01, FSDR2B2-OPR01, FSDR2N, FSDR2N-OPR01, FSDR2N2-OPR01, FSE2N...(Otros modelos se puede ver en la tienda web)		
accesorios para	418892		
	código	511472	referencia —
	tuerca rosca 3/8" H 4mm latón EC 21 UE 1 pzs		
	código	518393	referencia —
	junta plana FIBER ø ext. 24mm int.ø 17mm espesor 2mm UE 1 pzs		

ventiladores

ventilador axial

ebm-papst

			
1			
código	601082 ¹	referencia	3076620
descripción	ventilador axial L 92mm An 92mm H 25mm 230VAC 50/60Hz 9/11W cojinete rodamiento de bolas N° fabricante 3956 metal empalme conector Faston 2,8mm ebm-papst rodete ventilador ø 85mm resis.a la temp. 80°C		
Para modelos:	04WPEBV, 08WPEBV, 08WTPEV, 090PEB, 091FR1EX, 091FR11A, 091FR7G, 091FR7GS, 091FR7GX, 190PEB, 190TPE, 6BM, 6BR, 6CP, 6FR, 6FTL, 6FTR, 6PC, 6VTR, 6VTR2		
accesorios para	601082		
	código	691103	referencia —
	rejilla de protección ø 90mm distancia de sujeción 83mm para ventilador axial 92mm		



¹con rodamiento de bolas

importación

			
1			
código	601604 ¹	referencia	32M7130 32V5790
descripción	ventilador axial L 119mm An 119mm H 38mm 230VAC 50/60Hz 17/15W cojinete cojinete de fricción N° fabricante AA1282HS-AT empalme cable 300mm rodete ventilador ø 110mm resis.a la temp. 70°C consumo de corriente 0.1A caudal 130m³/h 2600rev/min		

¹con cojinete de fricción



código	601055 ¹	referencia	3113740 3205930
descripción	ventilador axial L 92mm An 92mm H 25mm 230VAC 50/60Hz 14.5/14W cojinete rodamiento de bolas empalme conector Faston 2,8mm metal ADDA rodete ventilador ø 85mm resis.a la temp. 70°C		
Para modelos:	08WPEBV, 08WTPPEV, 090PEB, 091FR1I, 091FR1ID, 091PEB, 10CP1EA, 10CP1IA, 12CP1EA, 12CP1IA, 18CP2EA, 18CP2IA, 190PEB, 190TPE, 191FR2I, 191FR2ID, 191PEB, 191TPE, 2091SCP, FX101E1, FX101E1R, FX101E2, FX101E2C, FX101E2C-VERS.032014, FX101E2R, FX101E2R-VERS.032014, FX101E2-VERS.032014, FX101E3, FX101E3C, FX101E3C-VERS.022014, FX101E3R, FX101E3R-VERS.022014, FX101E3-VERS.022014, FX101G1, FX101G1R, FX101G2, FX101G2C, FX101G2C-VERS.032014, FX101G2R, FX101G2R-VERS.032014, FX101G2-VERS.032014, FX101G3, FX101G3C, FX101G3C-VERS.022014, FX101G3R, FX101G3R-VERS.022014, FX101G3-VERS.022014, FX10E2CR, FX10E2CR-VERS.032014, FX10E3CR...(Otros modelos se puede ver en la tienda web)		
accesorios para	601055		
	código	550898	referencia —
	cable de conexión longitud del cable 2000mm empalme F 2,8 distancia de empalme 7.9mm para ventilador axial		
	código	691103	referencia —
	rejilla de protección ø 90mm distancia de sujeción 83mm para ventilador axial 92mm		

¹con rodamiento de bolas

ventiladores para frigoríficos



motores refrigeración universales

ELCO





serie N - multianclaje



código	601427	referencia	32M4041 32M6870
descripción	motor de ventilador ELCO 10W 230V 50/60Hz cojinete cojinete de fricción L1 49mm L2 59mm L3 86.5mm An 83mm empalme cable 500mm 1300/1550rev/min 5 opciones de montaje VNT10-20/028		
Para modelos:	120, 120B, 120NN, 120PV, 135, 135-4, 135A, 135B, 135BA, 135BN, 135BNX, 135BX, 135BXE, 135BXR, 135CPX, 135NN, 135NNX, 135PVX, 135X, 135X-3, 135X-4, 135XE, 135XR, 3G6SA, 3G6SA2, 3G6SA4, 40B, 40CP, 40CPX, 4G6SB, 4G6SB2, 4G6SB4, 4G6SB6, 55, 55B, 55PV, 65, 65A, 65B, 65BA, 65BX, 65BX-2, 65BXE, 65BXR, 65NB, 65NBX, 65NN, 65NNX, 65PVX, 65X...(Otros modelos se puede ver en la tienda web)		
repuestos para	601427		
	código	560140	referencia —
	tuerca hexagonal rosca M4 H 4.8mm inox EC 7 UE 20 pzs DIN/ISO DIN 985 autobloqueo		

repuestos para	601427		
	código	560332	referencia —
	arandela int.ø 4.3mm ø ext. 9mm espesor 0.8mm inox UE 1 pzs		
	código	560340	referencia —
	tuerca hexagonal rosca M4 H 3.2mm EC 7 inox DIN/ISO DIN 934 / ISO 4032/8673 UE 1 pzs		
	código	601413	referencia —
	placa de sujeción apto para rodete ventilador ø ext. 32mm eje ø 7 distancia de sujeción 26mm		



código	601430	referencia	32M4351
descripción	motor de ventilador ELCO 5W 230V 50/60Hz cojinete cojinete de fricción L1 48mm L2 52mm L3 79.5mm An 83mm empalme cable 500mm 1300/1550rev/min 5 opciones de montaje VNT5-13/027		
repuestos para	601430		
	código	560140	referencia —
	tuerca hexagonal rosca M4 H 4.8mm inox EC 7 UE 20 pzs DIN/ISO DIN 985 autobloqueo		
	código	560332	referencia —
	arandela int.ø 4.3mm ø ext. 9mm espesor 0.8mm inox UE 1 pzs		
	código	560340	referencia —
	tuerca hexagonal rosca M4 H 3.2mm EC 7 inox DIN/ISO DIN 934 / ISO 4032/8673 UE 1 pzs		
	código	601413	referencia —
	placa de sujeción apto para rodete ventilador ø ext. 32mm eje ø 7 distancia de sujeción 26mm		

serie N - estándar



código	601708 ¹	referencia	32M7020
descripción	motor de ventilador ELCO 10W 230V 50/60Hz cojinete cojinete de fricción L3 82.5mm An 66mm empalme Plug In longitud del cable mm 1300/1550rev/min VN10-20/1124		
Para modelos:	3G6SA, 3G6SA2, 3G6SA4, 40B, 40B-OPR01, 40BX-OPR01, 40CP-OPR01, 40CPX-OPR01, 4G6SB, 4G6SB2, 4G6SB4, 4G6SB6, 6BR15V, 6BR15VC, 6BR19V, 6BR19VC, 6EA, 6EA11, 6EA11A, 6EA11M, 6EA13, 6EA13A, 6EA13M, 6EA2, 6EA2A, 6EA2M, 6EAA, 6EAB, 6EABA, 6EABM, 6EAM, 6EB, 6EB11, 6EB11A, 6EB11M, 6EB13, 6EB13A, 6EB13M, 6EB2, 6EB22, 6EB22A, 6EB22M, 6EB2A, 6EB2M, 6EB4, 6EB4A, 6EB4M, 6EBA, 6EBM, 6EC...(Otros modelos se puede ver en la tienda web)		
repuestos para	601708		
		código	601413 referencia —
	placa de sujeción apto para rodete ventilador ø ext. 32mm eje ø 7 distancia de sujeción 26mm		
accesorios para	601708		
		código	601892 referencia —
	cable conector ELCO longitud del cable 1500mm 0.75mm ² protección IP42 para Plug-In		

¹con conexión codificado

serie RE



código	602051	referencia	32M7240
descripción	motor de ventilador 18/62W 230V 50/60Hz 2600rev/min		
Para modelos:	AGL6B, B151H, BF51H, FSD2B-OPR01, FSD2B2-OPR01, FSDR2B-OPR01, FSDR2B2-OPR01, FSE2B-OPR01, FSE2B2-OPR01, FSER2B-OPR01, FSER2B2-OPR01, IS51H, XS51H		

serie BT - motores de condensadores



código	601820 ¹	referencia	32M4701
descripción	motor de ventilador 35W 230V 50/60Hz L2 89mm L3 110mm An 82mm longitud del cable 2150mm 1300/1550rev/min ELCO con condensador condensador 2.5µF		
Para modelos:	ART2LD, ART2SD, DS51, DS51A, DS51C, DS51M, GR135BT, GR1A, GR2A, IA101L, IA101S, IS101L, IS101S, IS51, IS51A, IS51C, IS51M, ISFEB, ISFEB-OPR01, ISFEN, ISFEN-OPR01, SM1L, SM1L7, SM1L7A, SM1L7FCV, SM1L7M, SM1LA, SM1LAM, SM1LAT, SM1LM, SM1LT, SM1LT7, SM1LT7A, SM1LT7M, SM2L, SM2S, SM3S		

¹con condensador

IMPORTACIÓN

motores multianclaje



código	601022	referencia	32M0220 32M1060 32M4371
descripción	motor de ventilador 10W 230V 50-60Hz L1 44mm L2 54mm L3 85mm An 84mm longitud del cable 500mm 1300rev/min YZF10-20-18/26 5 opciones de montaje cojinete cojinete de fricción		
Para modelos:	120, 120B, 120NN, 120PV, 135, 135BN, 135NN, 55, 55B, 55PV, 65, 65B, 65NB, 65NN, 6BEABA, 6BEABB, 6BEABM, 6BEABZ, BRPR, BRPR218, BRVR, BRVR218, PGA20, PGA30, PGA40, PGA60, PGA80, PGW20, PGW30, PGW40, PGW60, PGW80, S125X, S60B, S60BX, S60X, SA87, SP120, SP120B, SP120BN, SP120NN, SP135, SP135BN, SP135CP, SP135NN, SP55, SP55B, SP65, SP65B, SP65NB...(Otros modelos se puede ver en la tienda web)		



código	601020	referencia	32M4350
descripción	motor de ventilador 5W 230V 50-60Hz L1 44mm L2 48mm L3 79mm An 84mm longitud del cable 500mm 1300rev/min YZF5-13-18/26 5 opciones de montaje cojinete cojinete de fricción		
Para modelos:	135BN, 135NN, 40CP, 40CPX, 65, 65NB, 65NN, S125B, S125BX, S125X, S60B, S60X, SP120BN, SP120NN, SP135BN, SP135CP, SP135NN, SP55, SP55B, SP65, SP65NB, SP65NN		



accesorios

rodetes de ventilador

aluminio

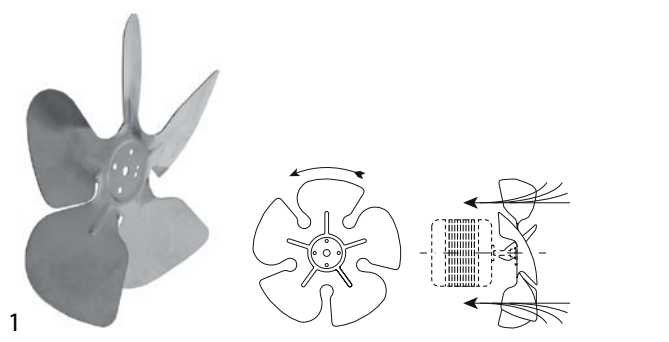

código	601070	referencia	32M3280
descripción	rodete ventilador aspirante ø 200mm fijación asta 25.4mm inclinación de la pala 28° An 38mm aluminio		
Para modelos:	135BN, 135BNX, 135CPX, 135NN, 135NNX, 3G6SA, 3G6SA2, 3G6SA4, 40B-OPR01, 40BX-OPR01, 40CP, 40CP-OPR01, 40CPX, 40CPX-OPR01, 4G6SB, 4G6SB2, 4G6SB4, 4G6SB6, 55B, 65, 65A, 65NB, 65NBX, 65NN, 65NNX, 65PVX, 65X, 65X-2, 65XE, 65XR, 6BR15V, 6BR15VC, 6BR19V, 6BR19VC, 6EA, 6EA11, 6EA11A, 6EA11M, 6EA13, 6EA13A, 6EA13M, 6EA2, 6EA2A, 6EA2M, 6EAA, 6EAM, 6JA, 6JA2, 6JA2A, 6JA2M...(Otros modelos se puede ver en la tienda web)		

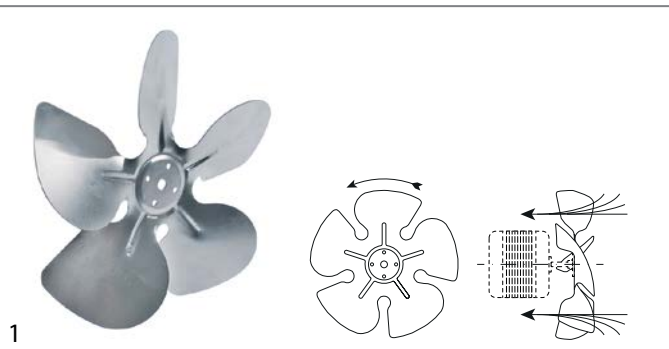

código	601282	referencia	32M1550
descripción	rodete ventilador aspirante ø 200mm fijación asta 25.4mm inclinación de la pala 34° An 44mm aluminio		
Para modelos:	135BN, 135BNX, 65B, 65BA, 65BX, 65BX-2, 65BXE, 65BXR, ART1L, ART1L7, ART1L7A, ART1L7M, ART1LA, CX120B, CX130, CX130B, CX130NN, CX60, CX60B, DA51, DA51A, DA51M, FX150, FX150B, FX150NN, FX70, FX70B, GD150B, ISFEB-OPR01, ISFEN-OPR01, MD130, MD130B, MD130BN, MD130NN, MD150, MD1504, MD150B, MD150B4, MD150BB, MD150BN, MD150BPV, MD150BR, MD150NCP, MD150NN, MD150PV, MD150R, MD60, MD60B, MD70, MD702...(Otros modelos se puede ver en la tienda web)		

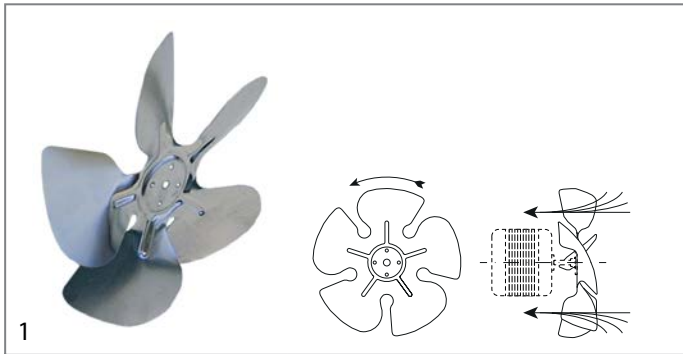

código	601072	referencia	32M1080
descripción	rodete ventilador aspirante ø 250mm fijación asta 25.4mm inclinación de la pala 25° An 50mm aluminio		
Para modelos:	120, 120B, 120NN, 120PV, 135, 135-4, 135A, 135B, 135BA, 135BN, 135BNX, 135BX, 135BXE, 135BXR, 135NN, 135NNX, 135PVX, 135X, 135X-3, 135X-4, 135XE, 135XR, 65B, 65BX, 65BX-2, 65NB, 65NBX, 65NN, 65NNX, 65PVX, AF1N, AF1N-OPR01, CX120, CX120NN, CX130, CX130B, CX140, CX140BN, CX140CP, CX140NN, CX140PV, CX150, CX150BN, CX150CP, CX150PV, CX55, CX55B, CX60B, CX65, CX652...(Otros modelos se puede ver en la tienda web)		

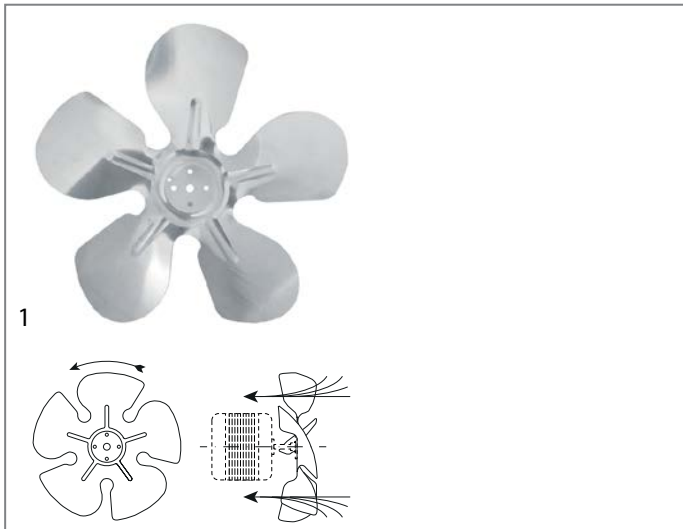



código	601387	referencia	32M2260
descripción	rodete ventilador aspirante ø 254mm fijación asta 25.4mm inclinación de la pala 34° An 50mm aluminio		
Para modelos:	135B, 135BX, AF2B, AF2B-OPR01, ART1LD, ART1LDA, BRPR, BRPR218, BRPR21C, BRPRV, BRVR, BRVR218, BRVR21C, BRVRV, CX120B, CX130B, CX140B, CX150B, D12Q1M, D12Q2, D12Q2M, FG2B, FSD2B, FSE2B, FSE2B2, GD150B, ISFEB, ISFEB-OPR01, ISFEN, ISFEN-OPR01, MD130B, MD150B, MD150B4, MD150BPV, MDE150B, MX120B, MX140B, PD130B, PD150B, PDG150B, S125B, S125B-4, S125BX, S125BX-4, SE14PRV, SE14PRW, SE14VRV, SE14VRW, SI14PRV, SI14PRW...(Otros modelos se puede ver en la tienda web)		

ventiladores de refrigeración

ebm-papst

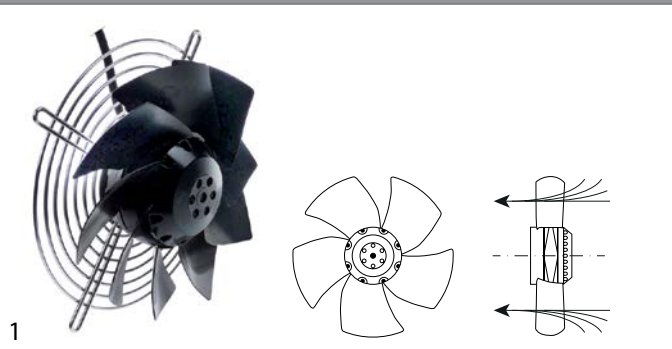
serie A2E



código	601663 ¹	referencia	32M6610
descripción	ventilador A2E200-AI38-10 rodete ventilador ø 200mm palas 9 230V 50/60Hz 64W 2600rev/min longitud del cable 450mm ebm-papst aspirante condensador apropiado 1.5µF con rejilla de protección		
Para modelos:	ART1L, ART1L7, ART1L7A, ART1L7M, ART1LA, ART2LD, ART2SD, ART3SD, DA51, DA51A, DA51M, DS31, DS31A, DS31C, DS31M, DS351H, SM03LT7, SM03LT7A, SM03LT7M		
repuestos para	601663		
	código	365171	referencia —
	condensador capacidad 1.5µF 400V tolerancia 5% 50/60Hz temperatura ambiente máx. -40 a +85°C ø 25mm L 50mm M8 plástico empalme cable 250mm MLR25PRL		
	código	601958	referencia —
	rejilla de protección ø 210mm para ventilador dist. del agujero 258mm		

¹con condensador y rejilla de protección

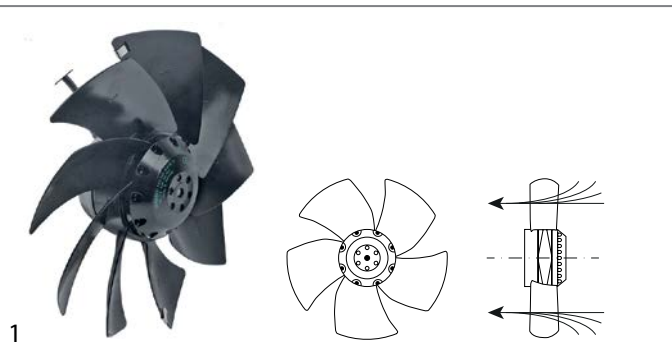

código	601964	referencia	32M4720 32M6850
descripción	ventilador A2E250AM06-12 rodete ventilador ø 250mm palas 9 230V 50/60Hz 115/150W ø 250mm 2450rev/min longitud del cable 1400mm aspirante condensador apropiado 3µF		
Para modelos:	ART1LD, ART1LD7, ART1LD7A, ART1LD7M, ART1LDA, DS51, DS51A, DS51C, DS51M, IA101L, IA101S, IA51, IA51A, IA51C, IA51M, IA72S, IS101L, IS101LR, IS101LW, IS101S, IS101SR, IS101SW, IS51, IS51A, IS51AR, IS51C, IS51CR, IS51H, IS51HW, IS51M, IS51MR, IS51R, IS51W, IS51WA, IS51WC, IS51WM, IS72S, IS72SR, IS72SW, ISFEB, ISFEB-OPR01, ISFEN, ISFEN-OPR01, SM1LAM, SM1LAT, SM1LM, SM1LT, SM1LT7, SM1LT7A, SM1LT7M...(Otros modelos se puede ver en la tienda web)		
repuestos para	601964		
	código	365137	referencia —
	condensador capacidad 3µF 450V tolerancia 5% 50/60Hz temperatura ambiente máx. -25 a + 85°C ø 25mm L 56mm M8 plástico empalme cable 250mm 416.17.77GF protección		

otros



código	601810	referencia	32M6220
descripción	ventilador 230V 50Hz ø 278mm condensador apropiado 4µF ECOFIT tipo 2VRE35 H 90mm rodete ventilador ø 250mm longitud del cable 2000mm		
Para modelos:	SM1L, SM1L7, SM1L7A, SM1L7FCV, SM1L7M, SM1LA, SM1LAR, SM1LAW, SM1LR, SM1LW, SM2L, SM2LR, SM2LW, SM2S, SM2SR, SM2SW, SM3S, SM3SR		

ventiladores tangenciales

COPREL

con bobina estándar



código	601032	referencia	32M2090
descripción	ventilador tangencial COPREL TFL(FN) rodillo ø 60mm L rodillo 180mm espesor de núcleo laminado 15mm posición del motor izquierdo 230V/50Hz 19W cojinete goma empalme conector Faston 6,3mm tipo de bobina caudal 107m ³ /h -10 a +60°C refrigeración		



código	601452	referencia	32M0050 32M0521 32M5920
descripción	ventilador tangencial TFL 180 rodillo ø 60mm L rodillo 180mm espesor de núcleo laminado 20mm posición del motor izquierdo 230V/50Hz 19W universal cojinete silicona empalme conector Faston 6,3mm caudal 100m ³ /h -30 a +100°C 230V 50Hz		
Para modelos:	120, 120NN, 120PV, 135CPX, 3G6SA, 3G6SA2, 3G6SA4, 40, 40-OPR01, 40PL, 40PV, 40PV-OPR01, 40X, 40X-OPR01, 40XPV, 4G6SB, 4G6SB2, 4G6SB4, 4G6SB6, 55, 55PV, 6BEA11A, 6BEA11B, 6BEA11M, 6BEA11Z, 6BEA2A, 6BEA2B, 6BEA2M, 6BEA2Z, 6BEA3A, 6BEA3B, 6BEA3M, 6BEA3Z, 6BEAA, 6BEAB, 6BEAM, 6BEAZ, 6BEB11A, 6BEB11B, 6BEB11M, 6BEB11Z, 6BEB22A, 6BEB22B, 6BEB22M, 6BEB22Z, 6BEB2A, 6BEB2B, 6BEB2M, 6BEB2Z, 6BEB3A...(Otros modelos se puede ver en la tienda web)		



ventiladores dobles



código	601026	referencia	32M1220 32M2210
descripción	ventilador tangencial COPREL TFD(FD) rodillo ø 60mm L rodillo 2x180mm espesor de núcleo laminado 35mm posición del motor centrado 230V/50-60Hz 42W refrigeración cojinete goma empalme conector Faston 6,3mm tipo de bobina caudal 255m³/h -10 a +60°C		

accesorios para ventiladores tangenciales

registros de calefacción



código	415122	referencia	32G1990
descripción	registro de calefacción distancia de sujeción 185mm An 40mm H 35mm 2000W 230V limitación de temperatura 105°C espirales 2 empalme cable longitud del cable 340mm L 197mm para soplador transversal		

motores de aire caliente



código	550687	referencia	33Q6320
descripción	brida para motor de ventilador		
Para modelos:	FCV3EM, FCV4E, FCV4EDS, FCV4EM		



código	552005	referencia	36E3160
descripción	brida para motor de ventilador ø ext. 56mm ø int. 1 38mm ø int. 2 20mm espesor 8mm latón		
Para modelos:	BX101E, BX101E-VERS.122013, BX101G, BX101G-VERS.122013, BX122E, BX122E-VERS.122013, BX122G, BX122G-VERS.122013, BX61E, BX61E-VERS.122013, BX61G, BX61G-VERS.122013, BX82E, BX82E-VERS.122013, BX82G, BX82G-VERS.122013, FC1011E, FC1011G, FC1221E, FC1221G, FC611E, FC611G, FM1011E1, FM1011E1-VERS.2006, FM1011E2, FM1011E2-VERS.2006, FM1011E3, FM1011E3-VERS.2006, FM1011G1, FM1011G1-VERS.2006, FM1011G2, FM1011G2-VERS.2006, FM1011G3, FM1011G3-VERS.2006, FM1221E1, FM1221E1-VERS.2006, FM1221E2, FM1221E2-VERS.2006, FM1221E3, FM1221E3-VERS.2006, FM1221G1, FM1221G1-VERS.2006, FM1221G2, FM1221G2-VERS.2006, FM1221G3, FM1221G3-VERS.2006, FM2011E2-VERS.2006, FM2011E3-VERS.2006, FM2011G2-VERS.2006, FM2011G3-VERS.2006...(Otros modelos se puede ver en la tienda web)		



código	552006	referencia	33Q5381
descripción	brida para motor de ventilador ø ext. 57.5mm ø int. 1 35mm ø int. 2 23mm espesor 2mm		
Para modelos:	FC101, FC101E, FC241, FC241E, FC241G, FC61, FC61E, FCV101, FCV101-CSA, FCV101DM, FCV101DM-CSA, FCV101DS, FCV101DS-CSA, FCV101E, FCV101EDM, FCV101EDM-UL, FCV101EDS, FCV101EDS-UL, FCV101E-UL, FCV141, FCV141-CSA, FCV141DM, FCV141DM-CSA, FCV141DS, FCV141DS-CSA, FCV141E, FCV141EDM, FCV141EDS, FCV241, FCV241DM, FCV241DS, FCV241E, FCV241EDM, FCV241EDM-UL, FCV241EDS, FCV241EDS-UL, FCV241E-UL, FCV241G, FCV241G-CSA, FCV241GDM, FCV241GDM-CSA, FCV241GDS, FCV241GDS-CSA, FCV401DM, FCV401DM-CSA, FCV401EDM, FCV401EDM-UL, FCV61, FCV61-CSA, FCV61DM...(Otros modelos se puede ver en la tienda web)		



código	697866	referencia	33Q5690
descripción	brida para motor de ventilador ø ext. 58mm ø int. 1 38.8mm ø int. 2 19/23mm latón		
Para modelos:	FC101, FC101E, FC241, FC241E, FC241G, FC61, FC61E, FCV101, FCV101-CSA, FCV101DM, FCV101DM-CSA, FCV101DS, FCV101DS-CSA, FCV101E, FCV101EDM, FCV101EDM-UL, FCV101EDS, FCV101EDS-UL, FCV101E-UL, FCV141, FCV141-CSA, FCV141DM, FCV141DM-CSA, FCV141DS, FCV141DS-CSA, FCV141E, FCV141EDM, FCV141EDS, FCV241, FCV241DM, FCV241DS, FCV241E, FCV241EDM, FCV241EDM-UL, FCV241EDS, FCV241EDS-UL, FCV241E-UL, FCV241G, FCV241G-CSA, FCV241GDM, FCV241GDM-CSA, FCV241GDS, FCV241GDS-CSA, FCV401DM, FCV401DM-CSA, FCV401EDM, FCV401EDM-UL, FCV61, FCV61-CSA, FCV61DM...(Otros modelos se puede ver en la tienda web)		



código	550688	referencia	3151490 3151490
descripción	cojinete para motor de ventilador		
Para modelos:	FC101, FC101E, FC241, FC241E, FC241G, FC61, FC61E, FCV101, FCV101-CSA, FCV101DM, FCV101DM-CSA, FCV101DS, FCV101DS-CSA, FCV101E, FCV101EDM, FCV101EDM-UL, FCV101EDS, FCV101EDS-UL, FCV101E-UL, FCV141, FCV141-CSA, FCV141DM, FCV141DM-CSA, FCV141DS, FCV141DS-CSA, FCV141E, FCV141EDM, FCV141EDS, FCV241, FCV241DM, FCV241DS, FCV241E, FCV241EDM, FCV241EDM-UL, FCV241EDS, FCV241EDS-UL, FCV241E-UL, FCV241G, FCV241G-CSA, FCV241GDM, FCV241GDM-CSA, FCV241GDS, FCV241GDS-CSA, FCV401DM, FCV401DM-CSA, FCV401EDM, FCV401EDM-UL, FCV61, FCV61-CSA, FCV61DM...(Otros modelos se puede ver en la tienda web)		



1

código	550686	referencia	37Q0250
descripción	junta para motor de ventilador int.ø 12mm ø ext. 58mm espesor 1mm con 3 orificios roscados		
Para modelos:	BX101E, BX101E-VERS.122013, BX101G, BX101G-VERS.122013, BX122E, BX122E-VERS.122013, BX122G, BX122G-VERS.122013, BX61E, BX61E-VERS.122013, BX61G, BX61G-VERS.122013, BX82E, BX82E-VERS.122013, BX82G, BX82G-VERS.122013, FC1011E, FC1011G, FC1221E, FC1221G, FC611E, FC611G, FCV3EM, FCV4E, FCV4EDS, FCV4EM, FM1011E1, FM1011E1-VERS.2006, FM1011E2, FM1011E2-VERS.2006, FM1011E3, FM1011E3-VERS.2006, FM1011G1, FM1011G1-VERS.2006, FM1011G2, FM1011G2-VERS.2006, FM1011G3, FM1011G3-VERS.2006, FM1221E1, FM1221E1-VERS.2006, FM1221E2, FM1221E2-VERS.2006, FM1221E3, FM1221E3-VERS.2006, FM1221G1, FM1221G1-VERS.2006, FM1221G2, FM1221G2-VERS.2006, FM1221G3, FM1221G3-VERS.2006...(Otros modelos se puede ver en la tienda web)		



2

código	550689	referencia	37Q3011
descripción	junta para motor de ventilador int.ø 40mm ø ext. 58mm espesor 1mm con 3 orificios roscados		
Para modelos:	FC101, FC101E, FC241, FC241E, FC241G, FC61, FC61E, FCV101, FCV101-CSA, FCV101DM, FCV101DM-CSA, FCV101DS, FCV101DS-CSA, FCV101E, FCV101EDM, FCV101EDM-UL, FCV101EDS, FCV101EDS-UL, FCV101E-UL, FCV141, FCV141-CSA, FCV141DM, FCV141DM-CSA, FCV141DS, FCV141DS-CSA, FCV141E, FCV141EDM, FCV141EDS, FCV241, FCV241DM, FCV241DS, FCV241E, FCV241EDM, FCV241EDM-UL, FCV241EDS, FCV241EDS-UL, FCV241E-UL, FCV241G, FCV241G-CSA, FCV241GDM, FCV241GDM-CSA, FCV241GDS, FCV241GDS-CSA, FCV3EM, FCV401DM, FCV401DM-CSA, FCV401EDM, FCV401EDM-UL, FCV4E, FCV4EDS...(Otros modelos se puede ver en la tienda web)		



1

código	550690	referencia	3150900
descripción	junta de árbol para motor de ventilador		
Para modelos:	FC101, FC101E, FC241, FC241E, FC241G, FC61, FC61E, FCV101, FCV101-CSA, FCV101DM, FCV101DM-CSA, FCV101DS, FCV101DS-CSA, FCV101E, FCV101EDM, FCV101EDM-UL, FCV101EDS, FCV101EDS-UL, FCV101E-UL, FCV141, FCV141-CSA, FCV141DM, FCV141DM-CSA, FCV141DS, FCV141DS-CSA, FCV141E, FCV141EDM, FCV141EDS, FCV241, FCV241DM, FCV241DS, FCV241E, FCV241EDM, FCV241EDM-UL, FCV241EDS, FCV241EDS-UL, FCV241E-UL, FCV241G, FCV241G-CSA, FCV241GDM, FCV241GDM-CSA, FCV241GDS, FCV241GDS-CSA, FCV401DM, FCV401DM-CSA, FCV401EDM, FCV401EDM-UL, FCV61, FCV61-CSA, FCV61DM...(Otros modelos se puede ver en la tienda web)		

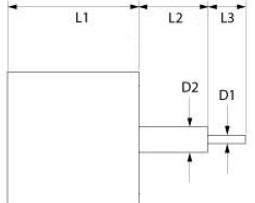
1

código	601104	referencia	32M4301
descripción	motor de ventilador 220-240V fases 1 50/60Hz 0,045/0,0765kW 2800/3400rev/min velocidades 1 L1 97mm L2 41mm L3 19mm D1 ø 8mm D2 ø 10mm 0.35A condensador apropiado 2µF/400V consumo 45W a 50 Hz 2800/3400rev/min		
Para modelos:	1G1FA0EV, 1G1FA0GV, 1G1PE1EV, 1G1PE2EV, 2G1FA0GV, 2G1PE1EV, 2G1PE2EV, 31GE, 31TC, 31TCE, 32TC, 32TCE		

1

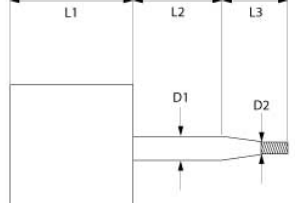
código	601043	referencia	32M1500
descripción	motor de ventilador 220-240V fases 1 50Hz 0,37/0,07kW 0,1/0,5PS 1400/2700rev/min velocidades 2 L1 123mm L2 107mm L3 15mm D1 ø 15mm D2 ø 12mm M10I M 2/0,7A condensador apropiado 20µF/250V a 50 Hz 1400/2700rev/min tipo 1057		
accesorios para	601043	código	365019
		referencia	—
		condensador de servicio capacidad 20µF 400V tolerancia 5% 50/60Hz temperatura ambiente máx. -25 a + 85°C ø 39,5mm L 70mm M8 plástico empalme conector Faston 6,3mm 16.10.25. protección	



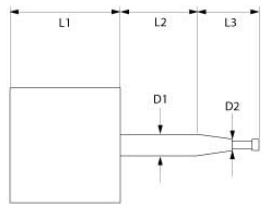

1

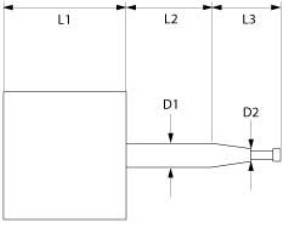
código	601210	referencia	32M4260
descripción	motor de ventilador 220-240V fases 1 50Hz 0.075kW 2800rev/min velocidades 1 L1 120mm L2 38mm L3 36mm D1 ø 12mm D2 ø 8mm M5D F 0.55A condensador apropiado 2,5µF/400V a 50 Hz 2800rev/min tipo 1074		
Para modelos:	FCV3EM, FCV4E, FCV4EDS, FCV4EM, FM423E1, FM423E2		

1

código	601211	referencia	32M3820
descripción	motor de ventilador 230/400-415V fases 3 50/60Hz 0.25kW 1400/1600rev/min velocidades 1 L1 175mm L2 70mm L3 27mm D1 ø 17mm D2 ø 12mm M8D F 1,4/0,8A a 50 Hz 1400rev/min a 60 Hz 1600rev/min tipo 10464530		
Para modelos:	FC101, FC101E, FC241, FC241E, FC241G, FC61, FC61E, FCV101, FCV101DS, FCV101E, FCV101EDS, FCV141, FCV141DS, FCV141E, FCV141EDS, FCV241, FCV241DS, FCV241E, FCV241EDS, FCV241G, FCV241GDS, FCV61, FCV61DS, FCV61E, FCV61EDS		
accesorios para	601211		
		código	550690 referencia 3150900
	junta de árbol para motor de ventilador		

1

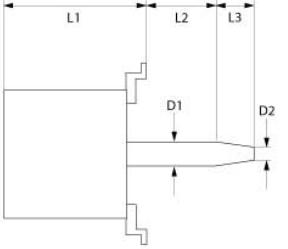
código	601713	referencia	32M6722
descripción	motor de ventilador 230/400V fases 1 50/60Hz 0.55kW 0.75PS 1400rev/min velocidades 1 L1 200mm L2 53mm L3 32mm D1 ø 18mm D2 ø 15mm M10x1 condensador apropiado 31,5µF Cos(fi) 0.72 a 50 Hz 1400rev/min a 60 Hz 1700rev/min tipo 3065A4051		
Para modelos:	FC1011E, FC1011G, FC1221E, FC1221G, FC611E, FC611G, FM1011E1, FM1011E1-VERS.2006, FM1011E2, FM1011E2-VERS.2006, FM1011E3, FM1011G1, FM1011G1-VERS.2006, FM1011G2, FM1011G2-VERS.2006, FM1011G3, FM1221E1, FM1221E1-VERS.2006, FM1221E2, FM1221E2-VERS.2006, FM1221E3, FM1221G1, FM1221G2, FM1221G3, FM2011E2-VERS.2006, FM2011G2-VERS.2006, FM2021E1, FM2021E2, FM2021E2-VERS.2006, FM2021E3, FM2021G1, FM2021G2, FM2021G3, FM611E1, FM611E1-VERS.2006, FM611E2, FM611E2-VERS.2006, FM611E3, FM611G1, FM611G1-VERS.2006, FM611G2, FM611G2-VERS.2006, FM611G3, FM721E1, FM721E1-VERS.2006, FM721E2, FM721E2-VERS.2006, FM721E3, FM721G1, FM721G1-VERS.2006...(Otros modelos se puede ver en la tienda web)		



1

código	602175	referencia	3103750
descripción	motor de ventilador 230/400V fases 3 50/60Hz 0.7kW 1400/1700rev/min L1 150mm L2 80mm L3 32mm D1 ø 18mm D2 ø 15mm M8 condensador apropiado 3µF400V tipo 3042P4050		
Para modelos:	BX101E, BX101E-VERS.122013, BX101G, BX101G-VERS.122013, BX61E, BX61E-VERS.122013, BX61G, BX61G-VERS.122013, BX82E, BX82E-VERS.122013, BX82G, BX82G-VERS.122013, FX101E1, FX101E1R, FX101E2, FX101E2C, FX101E2C-VERS.032014, FX101E2R, FX101E2R-VERS.032014, FX101E2-VERS.032014, FX101E3, FX101E3C, FX101E3C-VERS.022014, FX101E3R, FX101E3R-VERS.022014, FX101E3-VERS.022014, FX101G3, FX101G3C, FX101G3C-VERS.022014, FX101G3R, FX101G3R-VERS.022014, FX101G3-VERS.022014, FX10E2CR, FX10E2CR-VERS.032014, FX10E3CR, FX10E3CR-VERS.022014, FX10G3CR, FX10G3CR-VERS.022014, FX201E2, FX201E2P, FX201E2P-VERS.032014, FX201E2-VERS.032014, FX201E3, FX201E3P, FX201E3P-VERS.022014, FX201E3-VERS.022014, FX201G2P, FX201G2P-VERS.032014, FX201G3P, FX201G3-VERS.022014...(Otros modelos se puede ver en la tienda web)		

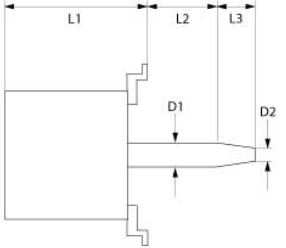
1

código	601598	referencia	3001182
descripción	motor de ventilador 230V fases 1 50Hz 0,22/0,55kW 960/1430rev/min velocidades 2 L1 175mm L2 52mm L3 32mm D1 ø 15mm D2 ø 18mm M10D F 1,7/3,7A condensador apropiado 36/25 Cos(fi) 0.96 a 50 Hz 960/1430rev/min tipo LM/FB 100L		
Para modelos:	FM1011G1, FM1011G2, FM1011G3, FM1011G3-VERS.2006, FM2011G3-VERS.2006, FM611G1, FM611G2, FM611G3, FM611G3-VERS.2006, FM721G1, FM721G2, FM721G3, FM721G3-VERS.2006		

1

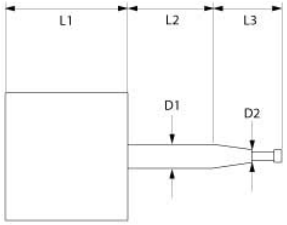
código	601212	referencia	32M3880
descripción	motor de ventilador 380-400-415V fases 3 50Hz 0,04/0,33PS 700/1400rev/min velocidades 2 L1 180mm L2 70mm L3 27mm D1 ø 17mm D2 ø 12mm M8D F 0,4/0,9A a 50 Hz 700/1400rev/min tipo 1046/4-8		
Para modelos:	FCV101DM, FCV101EDM, FCV141DM, FCV141EDM, FCV241DM, FCV241EDM, FCV241GDM, FCV401EDM, FCV61DM, FCV61EDM		



1

código	601109	referencia	32M0370
descripción	rodete ventilador D1 ø 160mm H1 35mm palas 12 D2 ø 8mm D3 ø 8mm H2 15mm		
Para modelos:	1G1FA0EV, 1G1FA0GV, 1G1PE1EV, 1G1PE2EV, 2G1FA0GV, 2G1PE1EV, 2G1PE2EV, 31GE, 31TC, 31TCE, 32TC, 32TCE		



1

código	514449	referencia	32M6741
descripción	rodete ventilador D1 ø 283mm H1 140mm palas 8 D2 ø 15mm D3 ø 18mm		
Para modelos:	FC611E, FC611G, FM611E1, FM611E1-VERS.2006, FM611E2, FM611E2-VERS.2006, FM611E3, FM611E3-VERS.2006, FM611G1, FM611G1-VERS.2006, FM611G2, FM611G2-VERS.2006, FM611G3, FM611G3-VERS.2006		



1

código	601221	referencia	32M4270 32M4271
descripción	rodete ventilador D1 ø 180mm H1 60mm palas 12 D2 ø 9mm D3 ø 12.5mm H2 35mm		
Para modelos:	FCV3EM, FCV4E, FCV4EDS, FCV4EM, FM423E1, FM423E2		



1

código	601208	referencia	32M2561
descripción	rodete ventilador D1 ø 335mm H1 135mm palas 12 D2 ø 12mm D3 ø 18mm H2 56mm		
Para modelos:	FC101, FC101E, FCV101, FCV101-CSA, FCV101DM, FCV101DM-CSA, FCV101DS, FCV101DS-CSA, FCV101E, FCV101EDM, FCV101EDM-UL, FCV101EDS, FCV101EDS-UL, FCV101E-UL, FCV141, FCV141-CSA, FCV141DM, FCV141DM-CSA, FCV141DS, FCV141DS-CSA, FCV141E, FCV141EDM, FCV141EDS, FCV72EDM-UL, FCV72EDS-UL, FCV72E-UL		



1

código	601060	referencia	32M1570
descripción	rodete ventilador D1 ø 180mm H1 60mm palas 16 D2 ø 11mm D3 ø 16mm H2 30mm		



1

código	601209	referencia	32M3992
descripción	rodete ventilador D1 ø 400mm H1 135mm palas 20 D2 ø 12mm D3 ø 18mm H2 54mm		
Para modelos:	FC241E, FC241G, FCV241E, FCV241EDM, FCV241EDM-UL, FCV241EDS, FCV241EDS-UL, FCV241E-UL, FCV241G, FCV241G-CSA, FCV241GDM, FCV241GDM-CSA, FCV241GDS, FCV241GDS-CSA, FCV401EDM, FCV401EDM-UL		



1

código	601207	referencia	32M3811 32M3812
descripción	rodete ventilador D1 ø 280mm H1 135mm palas 12 D2 ø 12mm D3 ø 18mm H2 55mm		
Para modelos:	FC61, FC61E, FCV61, FCV61-CSA, FCV61DM, FCV61DM-CSA, FCV61DS, FCV61DS-CSA, FCV61E, FCV61EDM, FCV61EDM-UL, FCV61EDS, FCV61EDS-UL, FCV61E-UL		



código	602173	referencia	32M6760 32M6761
descripción	rodete ventilador palas 12 D1 ø 365mm D2 ø 14mm D3 ø 18mm H1 140mm H2 23mm		
Para modelos:	FC1221E, FC1221G, FM1221E1, FM1221E1-VERS.2006, FM1221E2, FM1221E2-VERS.2006, FM1221E3, FM1221E3-VERS.2006, FM1221G1, FM1221G1-VERS.2006, FM1221G2, FM1221G2-VERS.2006, FM1221G3, FM1221G3-VERS.2006, FM2021E1, FM2021E2, FM2021E2-VERS.2006, FM2021E3, FM2021E3-VERS.2006, FM2021G1, FM2021G2, FM2021G2-VERS.2006, FM2021G3, FM2021G3-VERS.2006		

ventiladores de aire caliente

otros

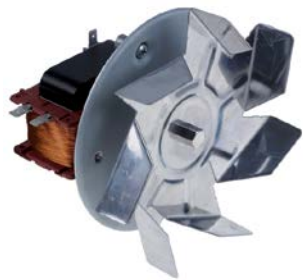

1

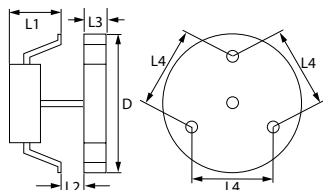

código	601011	referencia	32M0360 32M2320 32M2420 32M5690
descripción	ventilador de aire caliente 220-240V 40W 50/60Hz L1 65mm L2 15mm L3 25mm L4 87mm rodete ventilador ø 150mm FIME tipo C25R8023CLH		
Para modelos:	A12A1E, A12B1E, A12B2E, A12M1E, A12Z1E, A12Z2E, A14A1E, A14B1E, A14B2E, A14M1E, A14Z1E, A14Z2E, A16A1E, A16B1E, A16B2E, A16M1E, A16Z1E, A16Z2E, A18A1E, A18B1E, A18B2E, A18M1E, A18Z1E, A18Z2E, A20A1E, A20B1E, A20B2E, A20M1E, A20Z1E, A20Z2E, ACBM, ACBM218, ACPN, ACPN218, AJ12AE, AJ12ME, AJ14AE, AJ14ME, AJ16AE, AJ16ME, AJ18AE, AJ18ME, AJ20AE, AJ20ME, SL14CPN, SL14CVB, SL21CPN, SL21CVB		
accesorios para	601011		
	código	550879	referencia —
	aislamiento ø 130mm espesor 3mm agujero ø 20mm para ventilador aire caliente		

accesorios para	601011		
	código	601260	referencia —
	tuerca rosca M6I F para ventilador aire caliente		

accesorios

rodetes de ventilador para ventiladores de aire caliente



1

código	601710	referencia	32M2510
descripción	rodete ventilador ø 225mm soporte de eje ø 7mm aluminio palas 5		
Para modelos:	120, 120NN, 135A, 135BN, 135BNX, 135CPX, 135XE, 40B, 40CP, 40CPX, 55B, 65, 65A, 65BA, 65BXE, 65NB, 65NBX, 65NN, 65NNX, 65PVX, 65X, 65X-2, 65XE, 6BEA11A, 6BEA11B, 6BEA11M, 6BEA11Z, 6BEA2A, 6BEA2B, 6BEA2M, 6BEA2Z, 6BEA3A, 6BEA3B, 6BEA3M, 6BEA3Z, 6BEAA, 6BEAB, 6BEABA, 6BEABB, 6BEABM, 6BEABZ, 6BEAM, 6BEAZ, 6BEB11A, 6BEB11B, 6BEB11M, 6BEB11Z, 6BEB22A, 6BEB22B, 6BEB22M...(Otros modelos se puede ver en la tienda web)		

ventiladores radiales

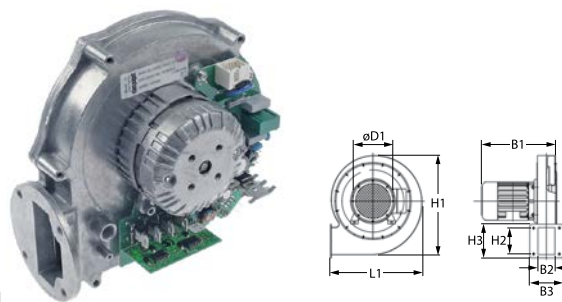

1

código	601870	referencia	32V6840
descripción	ventilador radial 230/240V tensión AC 50/60Hz H1 180mm L1 175mm D1 ø 75mm B1 80mm B2 50mm H2 50mm B3 83mm H3 83mm		
Para modelos:	FC1221G, FM1221G1, FM1221G1-VERS.2006, FM1221G2, FM1221G2-VERS.2006, FM1221G3, FM1221G3-VERS.2006, FM2021G1, FM2021G2, FM2021G2-VERS.2006, FM2021G3, FM2021G3-VERS.2006		

código	601599	referencia	32V5830
descripción	ventilador radial 230V tensión AC 50Hz 60W H1 175mm L1 205mm D1 ø 109mm B1 135mm B2 58mm H2 58mm vaporizador combinado		
Para modelos:	FC1011G, FC611G, FM1011G1, FM1011G1-VERS.2006, FM1011G2, FM1011G2-VERS.2006, FM1011G3, FM1011G3-VERS.2006, FM2011G2-VERS.2006, FM2011G3-VERS.2006, FM611G1, FM611G1-VERS.2006, FM611G2, FM611G2-VERS.2006, FM611G3, FM611G3-VERS.2006, FM721G1, FM721G1-VERS.2006, FM721G2, FM721G2-VERS.2006, FM721G3, FM721G3-VERS.2006		

accesorios en general

código	801197	referencia	3018670 6003060
descripción	extractora para rodetes de ventilador soporte ø 27-33mm rosca M16x1,5 EC 17		
Para modelos:	FM1011E1, FM1011E2, FM1011E3, FM1011G1, FM1011G2, FM1011G3, FM1221E1, FM1221E2, FM1221E3, FM1221G1, FM1221G2, FM1221G3, FM611E1, FM611E2, FM611E3, FM611G1, FM611G2, FM611G3		
repuestos para	801197		
	código	referencia	3019160
	801198		
	tornillo para extractora rosca M16x1,5 L 63mm EC 17		

bombas

bombas de lavado y aclarado

ALBA (C&A)

bombas

código	500180	referencia	32M2950
descripción	bomba entrada ø 28mm salida ø 28mm tipo C7670 230V 50Hz fases 1 0.11kW 0.15PS L 190mm dirección de rodadura derecho condensador 6.3µF ALBA PUMPS (C&A)		
Para modelos:	LT10R		
repuestos para	500180		
	código	referencia	—
	365012		
	condensador de servicio capacidad 6.3µF 450V tolerancia 5% 50Hz temperatura ambiente máx. -25 a + 85°C ø 30mm L 61mm M8 plástico empalme conector Faston 6,3mm protección		
	código	referencia	—
	510692		
	sello mecánico para árbol ø 11mm anillo deslizante ø ext. 24mm anillo deslizante H 13mm contraarandela montaje ø 26mm altura contraarandela 8mm contraarandela ø int. 14mm		
	código	referencia	—
	521222		
	rotor ø 72mm H 19mm rosca M7L árbol ø 11mm longitud árbol 29mm palas 3		
	código	referencia	—
	521518		
	cubierta de bomba ALBA PUMPS (C&A) entrada ø 28mm salida ø 28mm sentido de rotación derecho ø 93mm int.ø 76mm altura interior 31mm		
	código	referencia	—
	532490		
	junta tórica EPDM espesor 2.62mm int.ø 72.69mm UE 1 pzs		



1

código	500181	referencia	32M2940
descripción	bomba entrada ø 45mm salida ø 40mm tipo C7675 230V 50Hz fases 1 0.29kW 0.4PS L 175mm dirección de rodadura derecho condensador 10µF ALBA PUMPS (C&A)		
Para modelos:	LT20F, LT25F		
repuestos para	500181		
	código	365015	referencia —
	condensador de servicio capacidad 10µF 400V tolerancia 5%Hz temperatura ambiente máx. -25 a + 85°C ø 35.5mm L 59mm M8 plástico empalme conector Faston 6,3mm protección		
	código	509018	referencia —
	junta tórica EPDM espesor 3.53mm int.ø 107.5mm UE 1 pzs		
	código	509028	referencia —
	rotor ø 87mm H 21mm dirección de rodadura derecho rosca M7L árbol ø 12mm		
	código	510693	referencia 3036790 3152080
	sello mecánico para árbol ø 12mm anillo deslizante ø ext. 24mm anillo deslizante H 15.5mm anillo deslizante ø int. 11mm contraarandela montaje ø 24mm altura contraarandela 8mm contraarandela ø int. 13.5mm		
	código	521528	referencia 36G8080
	cubierta de bomba ALBA PUMPS (C&A) entrada ø 45mm salida ø 40mm sentido de rotación derecho ø 129mm int.ø 105mm altura interior 19mm		

FIR

bombas







1

código	500010	referencia	32M2140
descripción	bomba entrada ø 45mm salida ø 40mm tipo 2292.1506 230V 50Hz fases 1 0.55kW 0.75PS L 238mm dirección de rodadura derecho condensador 12.5µF FIR		
Para modelos:	L40, L40S		
repuestos para	500010		
	código	365014	referencia 32Z1310
	condensador de servicio capacidad 12.5µF 450V tolerancia 5%Hz temperatura ambiente máx. -25 a + 85°C ø 35mm L 70mm M8 plástico empalme conector Faston 6,3mm 45S.C3DS.12,5 protección		
	código	510600	referencia 32G0260
	rotor ø 102mm H 29mm soporte de eje ø 9/8mm dirección de rodadura derecho palas 6		
	código	510692	referencia —
	sello mecánico para árbol ø 11mm anillo deslizante ø ext. 24mm anillo deslizante H 13mm contraarandela montaje ø 26mm altura contraarandela 8mm contraarandela ø int. 14mm		
	código	521023	referencia —
	cubierta de rondete de ventilador ø ext. 150mm H 70mm para bomba de lavado		
	código	521506	referencia —
	cubierta de bomba FIR entrada ø 45mm salida ø 40mm sentido de rotación derecho ø 160mm int.ø 125mm altura interior 25mm		
	código	521702	referencia —
	junta de tapa de bomba espesor 3,5x4,5mm UE 1 pzs		



1

código	500023	referencia	32M3660
descripción	bomba entrada ø 63mm salida ø 47mm tipo 1225.2725 230/400V 50Hz fases 3 1.1kW 1.5PS L 335mm dirección de rodadura derecho FIR		
repuestos para	500023		
	código	510602	referencia —
	rotor ø 110mm H 34mm dirección de rodadura derecho rosca M8L árbol ø 28mm soporte ø 12.2mm palas 6		
	código	510693	referencia 3036790 3152080
	sello mecánico para árbol ø 12mm anillo deslizando ø ext. 24mm anillo deslizando H 15.5mm anillo deslizando ø int. 11mm contraarandela montaje ø 24mm altura contraarandela 8mm contraarandela ø int. 13.5mm		
	código	521513	referencia 36D8510
	cubierta de bomba FIR entrada ø 63mm salida ø 47mm sentido de rotación derecho int.ø 150mm altura interior 32mm		
	código	524416	referencia —
	junta de tapa de bomba espesor 4x4mm UE 1 pzs		

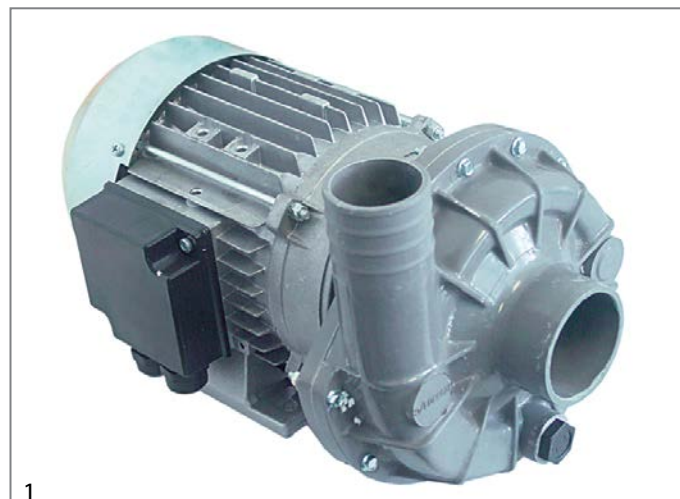

1

código	500323	referencia	32M1480
descripción	bomba entrada ø 63mm salida ø 47mm tipo 1227.2721 230/400V 50Hz fases 3 2kW 2.7PS L 335mm dirección de rodadura derecho FIR		
Para modelos:	L100		
repuestos para	500323		
	código	510599	referencia —
	rotor ø 123mm H 34mm M8L		
	código	510693	referencia 3036790 3152080
	sello mecánico para árbol ø 12mm anillo deslizando ø ext. 24mm anillo deslizando H 15.5mm anillo deslizando ø int. 11mm contraarandela montaje ø 24mm altura contraarandela 8mm contraarandela ø int. 13.5mm		
	código	521513	referencia 36D8510
	cubierta de bomba FIR entrada ø 63mm salida ø 47mm sentido de rotación derecho int.ø 150mm altura interior 32mm		
	código	524416	referencia —
	junta de tapa de bomba espesor 4x4mm UE 1 pzs		



1

código	500742	referencia	32M1590
descripción	bomba entrada ø 63mm salida ø 47mm tipo 1226.2602 230/400V 50Hz fases 3 1.5kW 2PS L 333mm dirección de rodadura izquierdo FIR		
Para modelos:	L80		





1





código	500117	referencia	32M0020
descripción	bomba entrada ø 63mm salida ø 47mm tipo 4225.22725 230/400V 50Hz fases 3 1.4kW 2PS L 280mm dirección de rodadura derecho FIR		
Para modelos:	L80		
repuestos para	500117		
	código	510602	referencia —
	rotor ø 110mm H 34mm dirección de rodadura derecho rosca M8L árbol ø 28mm soporte ø 12.2mm palas 6		

Continúa en la página siguiente

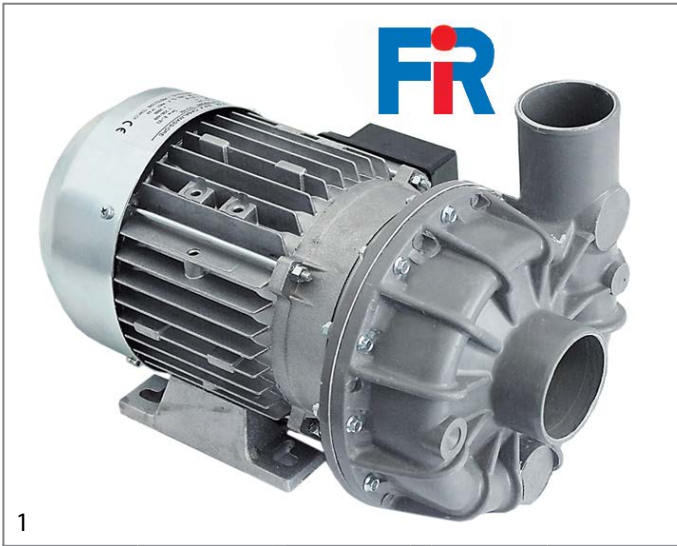





repuestos para 500117			
	código	510693	referencia 3036790 3152080
sello mecánico para árbol ø 12mm anillo deslizando ø ext. 24mm anillo deslizando H 15.5mm anillo deslizando ø int. 11mm contraarandela montaje ø 24mm altura contraarandela 8mm contraarandela ø int. 13.5mm			
	código	521513	referencia 36D8510
cubierta de bomba FIR entrada ø 63mm salida ø 47mm sentido de rotación derecho int.ø 150mm altura interior 32mm			
	código	524416	referencia —
junta de tapa de bomba espesor 4x4mm UE 1 pzs			



código	500111	referencia	32M4820
descripción	bomba entrada ø 63mm salida ø 53mm tipo 1241.2500 230/400V 50Hz fases 3 1.1kW 1.5PS L 330mm dirección de rodadura izquierdo FIR		
Para modelos:	C304AD, C304AD-VERS.2006, C304AS, C304AS-VERS.2006, C304AVD, C304AVD-VERS.2006, C304AVS, C304AVS-VERS.2006, C304D, C304D-VERS.2006, C304S, C304S-VERS.2006, C304VD, C304VD-VERS.2006, C304VS, C304VS-VERS.2006, CS243S-VERS.2006, CS370AD, CS370AD-VERS.2006, CS370AS, CS370AS-VERS.2006, CS370AVD, CS370AVD-VERS.2006, CS370AVS, CS370AVS-VERS.2006, CS370D, CS370D-VERS.2006, CS370S, CS370S-VERS.2006, CS370VD, CS370VD-VERS.2006, CS370VS, CS370VS-VERS.2006, CS466AD, CS466AD-VERS.2006, CS466AS, CS466AS-VERS.2006, CS466AVD, CS466AVD-VERS.2006, CS466AVS, CS466AVS-VERS.2006, CS466D, CS466D-VERS.2006, CS466S, CS466S-VERS.2006, CS466VD, CS466VD-VERS.2006, CS466VS, CS466VS-VERS.2006		
repuestos para 500111			
	código	510531	referencia —
cubierta de bomba FIR entrada ø 63mm salida ø 53mm presión secundaria M16x1,5mm presión secundaria abierto sentido de rotación izquierdo ø 185mm int.ø 150mm altura interior 37mm			
	código	510612	referencia —
rotor ø 110mm H 34mm M8R			
	código	510693	referencia 3036790 3152080
sello mecánico para árbol ø 12mm anillo deslizando ø ext. 24mm anillo deslizando H 15.5mm anillo deslizando ø int. 11mm contraarandela montaje ø 24mm altura contraarandela 8mm contraarandela ø int. 13.5mm			
	código	524416	referencia —
junta de tapa de bomba espesor 4x4mm UE 1 pzs			





LGB



código	500094	referencia	32M2920
descripción	bomba entrada ø 28mm salida ø 26mm tipo ZF131SX 230V 50Hz fases 1 0.2kW 0.15PS L 195mm dirección de rodadura izquierdo condensador 6.3µF LGB		
Para modelos:	F60PR, F60T, F80P, F80PR		
repuestos para 500094			
	código	365012	referencia —
condensador de servicio capacidad 6.3µF 450V tolerancia 5% 50Hz temperatura ambiente máx. -25 a + 85°C ø 30mm L 61mm M8 plástico empalme conector Faston 6,3mm protección			
	código	502266	referencia —
cubierta de bomba entrada ø 28mm salida ø 26mm			
	código	510703	referencia —
sello mecánico para árbol ø 13mm anillo deslizando H 13mm altura contraarandela 5.5mm ø ext. 26mm			
	código	521085	referencia —
rotor ø 72mm H 17mm rosca M7L árbol ø 13mm longitud árbol 12mm palas 3			
	código	528800	referencia —
junta tórica EPDM espesor 2.62mm int.ø 75.87mm UE 1 pzs			



1

código	500508	referencia	32M2910 32M4760
descripción	bomba entrada ø 45mm salida ø 38mm tipo ZF320VSX 230V 50Hz fases 1 0.75kW 1PS L 230mm dirección de rodadura derecho condensador 12.5µF LGB		
Para modelos:	F60P, F60PR, F60T, F80P, F80PR, L45		
repuestos para	500508		
	código	365014	referencia 32Z1310
	condensador de servicio capacidad 12.5µF 450V tolerancia 5%Hz temperatura ambiente máx. -25 a + 85°C ø 35mm L 70mm M8 plástico empalme conector Faston 6,3mm 45S.C3DS.12,5 protección		
	código	510702	referencia 3152680
	sello mecánico altura contraarandela 5.5mm int.ø 12mm		
	código	521247	referencia —
	rotor ø 90mm H 27mm dirección de rodadura derecho rosca M8L palas 6		
	código	521542	referencia —
	cubierta de bomba LGB entrada ø 45mm salida ø 40mm presión secundaria 13mm presión secundaria abierto ø 150mm int.ø 120mm altura interior 25mm		
	código	521714	referencia —
	junta de tapa de bomba espesor 4x4mm UE 1 pzs		





1

código	500984	referencia	32M5770
descripción	bomba entrada ø 45mm salida ø 39mm tipo ZF270VSX 230V 50Hz fases 1 0.4kW L 209mm dirección de rodadura derecho condensador 10µF LGB		
Para modelos:	LF50, LF50E, LF50EM, LF50EMPS, LF50EMPS-VERS.122012, LF50EM-VERS.122012, LF50E-VERS.122012, LF50E-VERS.2007, LP70		







1

código	500377	referencia	32M4830
descripción	bomba entrada ø 61mm salida ø 52mm tipo ZF800DX 230/400V 50Hz fases 3 2kW 2.72PS L 330mm dirección de rodadura izquierdo LGB		
Para modelos:	C165D, C165S, C165VD, C165VS, C207D, C207D-VERS.2006, C207S, C207S-VERS.2006, C207VD, C207VD-VERS.2006, C207VS, C207VS-VERS.2006, C304AD, C304AD-VERS.2006, C304AS, C304AS-VERS.2006, C304AVD, C304AVD-VERS.2006, C304AVS, C304AVS-VERS.2006, C304D, C304D-VERS.2006, C304S, C304S-VERS.2006, C304VD, C304VD-VERS.2006, C304VS, C304VS-VERS.2006, C92D-VERS.2006, C92S-VERS.2006, C92VD-VERS.2006, C92VS-VERS.2006, CS243D, CS243D-VERS.2006, CS243S, CS243S-VERS.2006, CS243VD, CS243VD-VERS.2006, CS243VS, CS243VS-VERS.2006, CS370AD, CS370AD-VERS.2006, CS370AS, CS370AS-VERS.2006, CS370AVD, CS370AVD-VERS.2006, CS370AVS, CS370AVS-VERS.2006, CS370D, CS370D-VERS.2006...(Otros modelos se puede ver en la tienda web)		
repuestos para	500377		
	código	510551	referencia 3FL1123
	junta de tapa de bomba int.ø 158.3mm tipo bomba 1214/1293/1225 /2243/1226/1204/3473/1241 espesor 3.53mm EPDM UE 1 pzs		
	código	510694	referencia —
	sello mecánico para árbol ø 13mm altura contraarandela 8mm int.ø 11.5mm H 16mm montaje ø 24/26mm ø int. 1 14mm		
	código	521276	referencia —
	rotor ø 120mm H 39mm tipo bomba ZF800DX soporte de eje ø 12mm dirección de rodadura izquierdo rosca M8R bomba para ZF800DX palas 6		





Continúa en la página siguiente

repuestos para	500377			
	código	521516	referencia	—
	cubierta de bomba LGB entrada ø 62mm salida ø 52mm presión secundaria 12mm presión secundaria cerrado sentido de rotación izquierdo ø 190mm int.ø 150mm altura interior 40mm			



código	500376	referencia	32M6180	
descripción	bomba entrada ø 62mm salida ø 50mm tipo AM5225SX 230V 50Hz fases 1 0.9kW 1.2PS L 300mm dirección de rodadura derecho condensador 16µF LGB			
Para modelos:	LC80			
repuestos para	500376			
	código	365021	referencia	32Z6080
	condensador de servicio capacidad 16µF 425V tolerancia 5% 50/60Hz temperatura ambiente máx. -25 a + 85°C ø 35mm L 73mm simple M8 plástico empalme conector Faston 6,3mm 416.10.99 protección			
	código	510551	referencia	3FL1123
	junta de tapa de bomba int.ø 158.3mm tipo bomba 1214/1293/1225 /2243/1226/1204/3473/1241 espesor 3.53mm EPDM UE 1 pzs			
	código	510694	referencia	—
	sello mecánico para árbol ø 13mm altura contraarandela 8mm int.ø 11.5mm H 16mm montaje ø 24/26mm ø int. 1 14mm			
	código	512029	referencia	—
	rotor ø 103mm H 26mm rosca M8L árbol ø 19mm longitud árbol 15mm soporte ø 8.2mm			
	código	521536	referencia	—
	cubierta de bomba ALBA / LGB entrada ø 62mm salida ø 50mm presión secundaria 12mm presión secundaria cerrado sentido de rotación derecho ø 180mm int.ø 150mm altura interior 38mm			



código	500379	referencia	32M5740	
descripción	bomba entrada ø 62mm salida ø 50mm tipo ZF650SX 230/400V 50Hz fases 3 1.35kW 1.8PS L 335mm dirección de rodadura derecho LGB			
Para modelos:	LC100, N354D, N354S, N354VD, N354VS, N506D, N506S, N506VD, N506VS, N607D, N607S, N607VD, N607VS, N760D, N760S, N760VD, N760VS, N886D, N886S, N886VD, N886VS			
repuestos para	500379			
	código	510551	referencia	3FL1123
	junta de tapa de bomba int.ø 158.3mm tipo bomba 1214/1293/1225 /2243/1226/1204/3473/1241 espesor 3.53mm EPDM UE 1 pzs			
	código	510694	referencia	—
	sello mecánico para árbol ø 13mm altura contraarandela 8mm int.ø 11.5mm H 16mm montaje ø 24/26mm ø int. 1 14mm			
	código	521240	referencia	—
	rotor ø 110mm H 32mm dirección de rodadura izquierdo rosca M8L árbol ø 20mm longitud árbol 10mm soporte ø 8.2mm palas 6			
	código	521536	referencia	—
	cubierta de bomba ALBA / LGB entrada ø 62mm salida ø 50mm presión secundaria 12mm presión secundaria cerrado sentido de rotación derecho ø 180mm int.ø 150mm altura interior 38mm			



OLYMPIA

bombas



1

código	499257	referencia	3037780
descripción	bomba entrada \varnothing 1" F salida \varnothing 30mm tipo L63.T45F_2V 230V 50Hz fases 1 0.33kW L 230mm dirección de rodadura izquierdo condensador 8 μ F OLYMPIA		
Para modelos:	KD40		
repuestos para	499257		
	código	365013	referencia 32Z2490
	condensador de servicio capacidad 8 μ F 400V tolerancia 5%Hz temperatura ambiente máx. -25 a + 85°C \varnothing 31.5mm L 55mm M8 plástico empalme conector Faston 6,3mm protección		
	código	509007	referencia —
	rotor \varnothing 85mm H 20mm dirección de rodadura izquierdo rosca M10R árbol \varnothing 12mm longitud árbol 7.5mm palas 12		
	código	510693	referencia 3036790 3152080
	sello mecánico para árbol \varnothing 12mm anillo deslizando \varnothing ext. 24mm anillo deslizando H 15.5mm anillo deslizando \varnothing int. 11mm contraarandela montaje \varnothing 24mm altura contraarandela 8mm contraarandela \varnothing int. 13.5mm		
	código	521167	referencia 3101190
	cubierta de bomba OLYMPIA entrada \varnothing 1"mm salida \varnothing 30/30mm int. \varnothing 94mm		
	código	521723	referencia 3116490
	junta de tapa de bomba EPDM espesor 2mm int. \varnothing 90mm UE 1 pzs		



1

código	500958	referencia	3034630
descripción	bomba entrada \varnothing 33mm salida \varnothing 30/28mm tipo T45 230V 50Hz fases 1 0.33kW 0.45PS L 215mm dirección de rodadura izquierdo condensador 8 μ F OLYMPIA		
Para modelos:	KD40, KD40LSPS, KD40LUX		
repuestos para	500958		
	código	365013	referencia 32Z2490
	condensador de servicio capacidad 8 μ F 400V tolerancia 5%Hz temperatura ambiente máx. -25 a + 85°C \varnothing 31.5mm L 55mm M8 plástico empalme conector Faston 6,3mm protección		
	código	510693	referencia 3036790 3152080
	sello mecánico para árbol \varnothing 12mm anillo deslizando \varnothing ext. 24mm anillo deslizando H 15.5mm anillo deslizando \varnothing int. 11mm contraarandela montaje \varnothing 24mm altura contraarandela 8mm contraarandela \varnothing int. 13.5mm		
	código	521257	referencia —
	rotor \varnothing 80mm H 12mm dirección de rodadura izquierdo rosca M10R árbol \varnothing 12mm longitud árbol 7.5mm palas 6		
	código	521551	referencia —
	cubierta de bomba OLYMPIA entrada \varnothing 33mm salida \varnothing 30mm salida 2 \varnothing 28 sentido de rotación izquierdo \varnothing 103mm int. \varnothing 93mm altura interior 30mm		
	código	521723	referencia 3116490
	junta de tapa de bomba EPDM espesor 2mm int. \varnothing 90mm UE 1 pzs		

bombas de aumento de presión I



código	500529	referencia	3234970
descripción	bomba entrada ø 60mm salida ø 48mm tipo T12 230V 50Hz fases 1 0.88kW 1.2PS L 270mm dirección de rodadura derecho condensador 16µF presión secundaria 10mm presión secundaria abierto OLYMPIA		
Para modelos:	KN80, KN800, KN800PSD, KN80PS		
repuestos para	500529		
	código	365021	referencia 32Z6080
	condensador de servicio capacidad 16µF 425V tolerancia 5% 50/60Hz temperatura ambiente máx. -25 a + 85°C ø 35mm L 73mm simple M8 plástico empalme conector Faston 6,3mm 416.10.99 protección		
	código	510693	referencia 3036790 3152080
	sello mecánico para árbol ø 12mm anillo deslizante ø ext. 24mm anillo deslizante H 15.5mm anillo deslizante ø int. 11mm contraarandela montaje ø 24mm altura contraarandela 8mm contraarandela ø int. 13.5mm		
	código	521010	referencia —
	rotor ø 98mm H 12mm M10L palas 8		
	código	521559	referencia —
	cubierta de bomba OLYMPIA entrada ø 60mm salida ø 48mm salida 2 ø 31 presión secundaria 10mm presión secundaria abierto sentido de rotación derecho ø 170mm int.ø 150mm altura interior 22mm		
	código	521727	referencia —
	junta de tapa de bomba EPDM espesor 1.78mm int.ø 145mm UE 1 pzs		



código	500358	referencia	3057760
descripción	bomba entrada ø 3/8" salida ø 3/8" tipo PS46 230V 50Hz 0.45kW ø 100mm L 200mm condensador 10µF LGB		
Para modelos:	KD100A, KD130A, KD60MA, KD60MPSA, KD85A, KD85PSA, LP151, LP70		
repuestos para	500358		
	código	510713	referencia —
	arandela fricción para árbol ø 12mm ø ext. 24mm H 16mm		
	código	510723	referencia —
	contraarandela H 8mm ø ext. 26mm int.ø 13.5mm per sello mecánico		
	código	698400	referencia —
	junta de tapa de bomba tipo bomba PS46 espesor 2mm int.ø 66mm UE 1 pzs		
accesorios para	500358		
	código	365015	referencia —
	condensador de servicio capacidad 10µF 400V tolerancia 5%Hz temperatura ambiente máx. -25 a + 85°C ø 35.5mm L 59mm M8 plástico empalme conector Faston 6,3mm protección		
	código	511279	referencia —
	empalme de tubo latón recto rosca 3/8" tubo ø 12mm UE 1 pzs		
	código	520202	referencia —
	empalme de tubo latón niquelado recto rosca 3/8" tubo ø 12mm UE 1 pzs		
	código	520677	referencia —
	empalme de tubo latón recto rosca 3/8" tubo ø 13mm UE 1 pzs		

bombas de salida

GRE			
código	500051	referencia	32M4430
descripción	bomba de desagüe entrada ø 22/25/30mm salida ø 22mm 100W 230V 50Hz GRE		
Para modelos:	PGA20, PGA30, PGA40, PGA60, PGA80, PGW20, PGW30, PGW40, PGW60, PGW80		





1

código	500980	referencia	32M5220
descripción	bomba de desagüe entrada ø 30mm salida ø 21mm 100W 230V 50Hz GRE		
Para modelos:	F60T, F80P		

otros



1

código	500201	referencia	N/A
descripción	bomba de desagüe entrada ø 24mm salida ø 22mm 230V 100W		

bombas de vibración



1

código	500972	referencia	32M7000 32M7001
descripción	bomba magnética 230V 47W 50Hz entrada ø 7 salida ø 1/8" F CEME tipo E507		
Para modelos:	FM1011E3, FM1011E3-VERS.2006, FM1011G3, FM1011G3-VERS.2006, FM1221E3, FM1221E3-VERS.2006, FM1221G3-VERS.2006, FM2011E3-VERS.2006, FM2011G3-VERS.2006, FM2021E3, FM2021E3-VERS.2006, FM2021G3, FM2021G3-VERS.2006, FM611E3, FM611E3-VERS.2006, FM611G3, FM611G3-VERS.2006, FM721E3, FM721E3-VERS.2006, FM721G3, FM721G3-VERS.2006		



1

código	520159	referencia	3007950
descripción	empalme de tubo latón niquelado recto rosca 1/8" tubo ø 6mm UE 1 pzs EC 12 longitud total 32mm rosca L 7.5mm boquilla ø 6mm longitud boquilla 19.5mm		
Para modelos:	FM1011E3, FM1011G3, FM1221E3, FM1221G3, FM2021E3, FM2021G3, FM423E2, FM611E3, FM611G3, FM721E3, FM721G3		

bombas para máquinas de cubitos de



1

código	501420	referencia	32M6430
descripción	bomba GRE 100W 230V 50Hz entrada ø 25mm salida ø 22mm L 150mm longitud total 230mm para máquina de hielo en cubitos		
Para modelos:	PG80C, PG81CW, PGC132, PGC132-VERS.200911, PGC134W, PGC134W-VERS.200911, PGC210, PGC210-VERS.200911, PGC212W, PGC212W-VERS.200911		
repuestos para	501420		
	código	695417	referencia
			aislamiento para bomba



1

código	500047	referencia	32M6310
descripción	bomba REBO tipo MH30F1 30W 230V 50Hz salida ø 12.7mm L 135mm dirección de rodadura izquierdo		
Para modelos:	PG22C, PG23C, PG23CW, PG24CW, PG30C, PG31CW, PG42C, PG43CW, PG60C, PG61CW		

condensadores y filtros antiparasitarios

condensadores de arranque

condensadores de arranque



1

código	365095	referencia	32V1490
descripción	condensador de arranque 43µF 330V 50/60Hz ciclo de trabajo 3 60A1D330043NXET ø 36mm L 80mm M8 plástico empalme cable 350mm 04P.5523CM		
Para modelos:	120, 120NN, 120PV, 135A, 135XE, 40, 40CP, 40CPX, 40EV, 40EVP, 40PV, 40X, 40XPV, 55, 55PV, 65A, 65XE, 6FMA11A, 6FMA11B, 6FMA11M, 6FMA11Z, 6FMA2A, 6FMA2B, 6FMA2M, 6FMA2Z, 6FMA4A, 6FMA4B, 6FMA4M, 6FMA4Z, 6FMAA, 6FMAB, 6FMAM, 6FMAZ, 6FMB11A, 6FMB11B, 6FMB11M, 6FMB11Z, 6FMB2A, 6FMB2B, 6FMB2M, 6FMB2Z, 6FMB4A, 6FMB4B, 6FMB4M, 6FMB4Z, 6FMBA, 6FMBB, 6FMBM, 6FMBZ, 6FMC11A...(Otros modelos se puede ver en la tienda web)		



condensadores de servicio

plástico



1

código	365014	referencia	32Z1310
descripción	condensador de servicio capacidad 12.5µF 450V tolerancia 5%Hz temperatura ambiente máx. -25 a + 85°C ø 35mm L 70mm M8 plástico empalme conector Faston 6,3mm 45S.C3DS.12,5 protección		
Para modelos:	L40, L40S		



1

código	365021	referencia	32Z6080
descripción	condensador de servicio capacidad 16µF 425V tolerancia 5% 50/60Hz temperatura ambiente máx. -25 a + 85°C ø 35mm L 73mm simple M8 plástico empalme conector Faston 6,3mm 416.10.99 protección		
Para modelos:	FC101, FC241, FC61, FCV101, FCV101DS, FCV141, FCV141DS, FCV141DS-CSA, FCV241, FCV241DS, FCV61, FCV61DS		



1

código	365224	referencia	32V6440
descripción	condensador de servicio capacidad 25µF 420V tolerancia 5% 50/60Hz ø 45mm L 75mm M8 plástico empalme conector Faston 6,3mm		
Para modelos:	FM1011G3, FM1011G3-VERS.2006, FM2011G3-VERS.2006, FM611G3, FM611G3-VERS.2006, FM721G3, FM721G3-VERS.2006, FX61G1, FX61G1R, FX61G2, FX61G2C, FX61G2CR, FX61G2R		



1

código	365225	referencia	32V5980
descripción	condensador de servicio capacidad 35µF 420V tolerancia 5% 50/60Hz temperatura ambiente máx. -25 a + 85°C ø 45mm L 95mm M8 plástico empalme conector Faston 6,3mm protección		
Para modelos:	FC1011G, FC611G, FM1011G1-VERS.2006, FM1011G2-VERS.2006, FM1011G3-VERS.2006, FM1221G1, FM1221G1-VERS.2006, FM1221G2, FM1221G2-VERS.2006, FM1221G3-VERS.2006, FM2011G2-VERS.2006, FM2011G3-VERS.2006, FM2021G2-VERS.2006, FM2021G3-VERS.2006, FM611G1-VERS.2006, FM611G2-VERS.2006, FM611G3-VERS.2006, FX101G1, FX101G1R, FX101G2, FX101G2C, FX101G2R, FX10G2CR, FX82G1, FX82G2, FX82G2C		



1

código	365022	referencia	32V6540
descripción	condensador de servicio capacidad 40µF 400V tolerancia 5%Hz temperatura ambiente máx. -25 a + 85°C ø 45mm L 95mm M8 plástico empalme conector Faston 6,3mm protección		
Para modelos:	BX101G, BX101G-VERS.122013, BX82G, BX82G-VERS.122013, FM1011G1, FM1011G2, FM1011G3, FM611G1, FM611G2, FM611G3, FM721G1, FM721G1-VERS.2006, FM721G2, FM721G2-VERS.2006, FM721G3, FM721G3-VERS.2006, FX101G1, FX101G1R, FX101G2, FX101G2C, FX101G2C-VERS.032014, FX101G2R, FX101G2R-VERS.032014, FX101G2-VERS.032014, FX10G2CR, FX10G2CR-VERS.032014, FX201G2, FX201G2P, FX201G2P-VERS.032014, FX201G2-VERS.032014, FX202G2, FX202G2-VERS.032014, FX82G1, FX82G2, FX82G2C, FX82G2T, FX82G2T-VERS.032014		



1

código	365013	referencia	32Z2490
descripción	condensador de servicio capacidad 8µF 400V tolerancia 5%Hz temperatura ambiente máx. -25 a + 85°C ø 31.5mm L 55mm M8 plástico empalme conector Faston 6,3mm protección		
Para modelos:	71AR		

filtros

filtros antiparasitarios

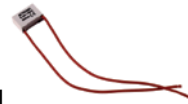

1

código	365065	referencia	32Z6100
descripción	filtro antiparasitario 1000Ohm capacidad 1µF		
Para modelos:	FCV101DM, FCV101DS, FCV101EDM, FCV101EDS, FCV141DM, FCV141DS, FCV141EDM, FCV141EDS, FCV241DM, FCV241DS, FCV241EDM, FCV241EDS, FCV241GDM, FCV241GDS, FCV401DM, FCV401EDM, FCV4E, FCV4EDS, FCV61DM, FCV61DM-CSA, FCV61DS, FCV61EDM, FCV61EDM-UL, FCV61EDS		



fusibles

fusibles finos

			
1			
código	358668	referencia	3201540
descripción	fusible fino medida ø5x20mm 0.5A rápido nominal 250V UE 10 pzs		
Para modelos:	04WFR3ED, 08WFR4ED, 08WGREV, 091FR3ED, 0A1FR1ED, 0A1FR3ED, 0D1FR1ED, 0D1FR3ED, 0G0FR3ED, 10CP1EA, 10CP1GA, 10CP1IA, 12CP1EA, 12CP1GA, 12CP1IA, 18CP2EA, 18CP2GA, 18CP2IA, 191FR4ED, 1A1FR2ED, 1A1FR4ED, 1D1FR2ED, 1D1FR4ED, 71RA, 91RA, FC101, FC101E, FC1011G, FC101E, FC1221E, FC1221G, FC241, FC241E, FC241G, FC61, FC61E, FC611G, FC61E, FCV101, FCV101DM, FCV101DS, FCV101E, FCV101EDM, FCV101EDS, FCV141, FCV141DM, FCV141DS, FCV141E, FCV141EDM, FCV141EDS...(Otros modelos se puede ver en la tienda web)		

			
2			
código	358671	referencia	3200020
descripción	fusible fino medida ø5x20mm 1A rápido nominal 250V UE 10 pzs		
Para modelos:	06WBR3E, 0G1BR3E, 191BR1E, 191BR1GA, 191BR2E, 191BR2EA, 191BR2GA, 1A1BR1E, 1A1BR1GA, 1A1BR2E, 1A1BR2EA, 1A1BR2GA, 1D1BR1E, 1D1BR1GA, 1D1BR2E, 1D1BR2EA, 1D1BR2GA, 1G1BR3E, 291BR1E, 291BR1GA, 291BR2E, 291BR2EA, 291BR2GA, 2A1BR1E, 2A1BR1GA, 2A1BR2E, 2A1BR2EA, 2A1BR2GA, 2D1BR1E, 2D1BR1GA, 2D1BR2E, 2D1BR2EA, 2D1BR2GA, 71ARE, 91ARE, FCV401DM, FCV401EDM		

			
1			
código	358031	referencia	32V6210
descripción	fusible fino medida ø10x38mm 10A nominal 500V tipo Gg rápido UE 1 pzs		
Para modelos:	BX101E, BX101E-VERS.122013, BX122E, BX122E-VERS.122013, BX61E, BX61E-VERS.122013, BX82E, BX82E-VERS.122013, FC1011E, FC1221E, FC611E, FM1011E1, FM1011E1-VERS.2006, FM1011E2, FM1011E2-VERS.2006, FM1011E3, FM1011E3-VERS.2006, FM1221E1, FM1221E1-VERS.2006, FM1221E2, FM1221E2-VERS.2006, FM1221E3-VERS.2006, FM2011E2-VERS.2006, FM2011E3-VERS.2006, FM2021E1, FM2021E2, FM2021E2-VERS.2006, FM2021E3, FM2021E3-VERS.2006, FM611E1, FM611E1-VERS.2006, FM611E2, FM611E2-VERS.2006, FM611E3, FM611E3-VERS.2006, FM721E1, FM721E1-VERS.2006, FM721E2, FM721E2-VERS.2006, FM721E3, FM721E3-VERS.2006, FX101E1, FX101E1R, FX101E2, FX101E2C, FX101E2C-VERS.032014, FX101E2R, FX101E2R-VERS.032014, FX101E2-VERS.032014, FX101E3...(Otros modelos se puede ver en la tienda web)		

accesorios eléctricos

cables

			
1			
cables de tierra			
código	100171	referencia	32A2400 32A2401
descripción	cable de tierra empalme F2,8mm / ojal M5 longitud del cable 1200mm		
Para modelos:	1A1FA1G, 1A1FA2G, 1A1FA4G, 1A1FA5G, 1A1FAAG, 1A1FABG, 1A1FAS2G, 1A1FASG, 1A1TP0G, 1A1TP0G-VERS.2002, 1B1FAS2G, 1B1FASG, 1D1FA1G, 1D1FA2G, 1D1FA4G, 1D1FA5G, 1D1FAAG, 1D1FABG, 1D1FAS2G, 1D1FASG, 1D1TP0G, 1D1TP0G-VERS.2002, 1G1BR1G, 2A1FA1G, 2A1FA4G, 2A1FAAG, 2A1FAS2G, 2A1FASG, 2A1TP3G, 2A1TP6G, 2A1TPCG, 2A1TPSG, 2D1FA1G, 2D1FA4G, 2D1FAAG, 2D1FAS2G, 2D1FASG, 2D1TP3G, 2D1TP6G, 2D1TPCG, 2D1TPSG, 3A1FA1G, 3A1FA4G, 3A1FAAG, 3A1FASG, 3D1FA1G, 3D1FA4G, 3D1FAAG, 3D1FASG, 60SM		

			
1			
código	104684	referencia	3113500
descripción	cable de tierra empalme F2,8mm / ojal M5 longitud del cable 350mm 1.5mm ²		
Para modelos:	BX101G, BX101G-VERS.122013, BX122G, BX122G-VERS.122013, BX61G, BX61G-VERS.122013, BX82G, BX82G-VERS.122013, FC1011G, FC611G, FM1011G1, FM1011G1-VERS.2006, FM1011G2, FM1011G2-VERS.2006, FM1011G3, FM1011G3-VERS.2006, FM2011G2-VERS.2006, FM2011G3-VERS.2006, FM611G1, FM611G1-VERS.2006, FM611G2, FM611G2-VERS.2006, FM611G3, FM611G3-VERS.2006, FM721G1, FM721G1-VERS.2006, FM721G2, FM721G2-VERS.2006, FM721G3, FM721G3-VERS.2006, FX101G1, FX101G1R, FX101G2, FX101G2C, FX101G2C-VERS.032014, FX101G2R, FX101G2R-VERS.032014, FX101G2-VERS.032014, FX101G3, FX101G3C, FX101G3C-VERS.022014, FX101G3R, FX101G3R-VERS.022014, FX101G3-VERS.022014, FX10G2CR, FX10G2CR-VERS.032014, FX10G3CR, FX10G3CR-VERS.022014, FX122G1, FX122G2...(Otros modelos se puede ver en la tienda web)		

			
1			
código	100173	referencia	32A0441
descripción	cable de tierra empalme F2,8mm / ojal M5 longitud del cable 620mm		
Para modelos:	031FT04, 031FT06, 070FT04, 070FT05, 071FT04, 071FT06, 090BM1G, 090FT04, 090FT05, 091FT04, 091FT06, 0A0FT1G, 0A0FT2G, 0A0FT4G, 0A0FT5G, 0A0GRG, 0B0FT1G, 0B0FT2G, 0B0FT4G, 0B0FT5G, 0D0FT1G, 0D0FT2G, 0D0FT4G, 0D0FT5G, 0D0GRG, 0G0FT1G, 0G0FT2G, 0G0FT4G, 0G0FT5G, 190BM2G, 1A0FT1G, 1A0FT2G, 1A0FT3G, 1A0FT4G, 1A0FT6G, 1A0GRG, 1B0FT1G, 1B0FT2G, 1B0FT3G, 1B0FT4G, 1B0FT6G, 1D0FT1G, 1D0FT2G, 1D0FT3G, 1D0FT4G, 1D0FT6G, 1D0GRG, 1G0FT1G, 1G0FT2G, 1G0FT3G...(Otros modelos se puede ver en la tienda web)		

			
1			
código	100183	referencia	32A2530
descripción	cable de tierra empalme F2,8mm / ojal M5 longitud del cable 900mm		
Para modelos:	08WCP1GM, 0A0BMG, 0A0FAVA, 0A1CP1G, 0B1CP1G, 0D0BMG, 0D0FAVA, 0D1CP1G, 0G1CP1G, 10WTPGE, 10WTPGV, 1A0BMG, 1A0FA2, 1A0FA5, 1A0FAB, 1A0FAS2, 1A0TP0, 1A1CP1G, 1A1CP2G, 1A1FA2G, 1A1FA5G, 1A1FABG, 1A1FAS2G, 1A1FASG, 1A1PD1G, 1A1PD2G, 1A1PI1G, 1A1PI1GA, 1A1TP0G, 1A1TP0G-VERS.2002, 1B0FAS2, 1B0TP0, 1B1FAS2G, 1D0BMG, 1D0FA2, 1D0FA5, 1D0FAB, 1D0FAS2, 1D0TP0, 1D1CP1G, 1D1CP2G, 1D1FA2G, 1D1FA5G, 1D1FABG, 1D1FAS2G, 1D1PD1G, 1D1PD2G, 1D1PI1G, 1D1PI1GA, 1D1TP0G...(Otros modelos se puede ver en la tienda web)		

componentes eléctricos



terminales de cable y conectores

aislado

conectores enchufables



1			
código	550326	referencia	32D0080
descripción	regleta de bornes 12 polos empalme conector Faston 6,3mm resis.a la temp. 140°C		
Para modelos:	0A1FR3G, 0A1FR3GD, 0D1FR3G, 0D1FR3GD, 0G1FR3G, 0G1FR3GD, 191BR1G, 191BR1GA, 191BR2G, 191BR2GA, 1A1BR1G, 1A1BR1GA, 1A1BR2G, 1A1BR2GA, 1A1FR4G, 1A1FR4GD, 1D1BR1G, 1D1BR1GA, 1D1BR2G, 1D1BR2GA, 1D1FR4G, 1D1FR4GD, 1G1FR4G, 1G1FR4GD, 291BR1G, 291BR1GA, 291BR2G, 291BR2GA, 2A1BR1G, 2A1BR1GA, 2A1BR2G, 2A1BR2GA, 2D1BR1G, 2D1BR1GA, 2D1BR2G, 2D1BR2GA		

conectores enchufables

1			
código	550171	referencia	32D0140
descripción	conector enchufable 10 polos STV 2/10		

1			
código	550952	referencia	32D0420
descripción	pieza de empalme 2 polos		

terminales

bornes de porcelana

1			
código	550112	referencia	3000060
descripción	conector de porcelana 2 polos 2.5mm ² máx. 10A máx. 250VT máx 200°C L 22mm An 17mm H 15mm distancia de sujeciónmm UE 1 pzs		

1			
código	104798	referencia	3113480
descripción	cable de tierra empalme F2,8mm/ojal M6 longitud del cable 600mm 1.5mm ²		
Para modelos:	FM1221G1, FM1221G1-VERS.2006, FM1221G2, FM1221G2-VERS.2006, FM1221G3, FM1221G3-VERS.2006, FM2021G1, FM2021G2, FM2021G2-VERS.2006, FM2021G3, FM2021G3-VERS.2006, FM721G1, FM721G2, FM721G3		

cables de cinta plana

grupo 1

1			
código	400066	referencia	3099170
descripción	cable de cinta plana 10 polos L 1000mm tipo de conector FC-10P medida reticular 2.54mm		
Para modelos:	KD85E, KD85EA, KD85EAT, KD85EPS, KD85EPSA, LP70		

1			
código	403293	referencia	32A2290
descripción	cable de cinta plana 16 polos L 1500mm tipo de conector 2 filas cifrado número de polos de conector 16		
Para modelos:	06WFR3GD, 08WFR4ED, 091FR1GD, 091FR3GD, 0A1FR1ED, 0A1FR1GD, 0A1FR1GD-VERS.2004, 0A1FR3GD, 0B1FR1GD, 0D1FR1ED, 0D1FR1GD, 0D1FR1GD-VERS.2004, 0D1FR3GD, 0G0FR3ED, 0G1FR3GD, 10WFR4GD, 191FR2GD, 191FR4GD, 1A1FR2ED, 1A1FR2GD, 1A1FR2GD-VERS.2004, 1D1FR2ED, 1D1FR2GD, 1D1FR2GD-VERS.2004, 1G1FR4GD		

cables de enlace

1			
código	579007	referencia	3116170
descripción	cable de datos L 1000mm 8 polos para horno a vapor combinado apto para ANGELO PO tipo de conector RJ45		
Para modelos:	BX122G, BX122G-VERS.122013, BX82G, BX82G-VERS.122013, FX101E1, FX101E1R, FX101E2, FX101E2C, FX101E2C-VERS.032014, FX101E2R, FX101E2R-VERS.032014, FX101E2-VERS.032014, FX101E3, FX101E3C, FX101E3C-VERS.022014, FX101E3R, FX101E3R-VERS.022014, FX101E3-VERS.022014, FX101G1, FX101G1R, FX101G2, FX101G2C, FX101G2C-VERS.032014, FX101G2R, FX101G2R-VERS.032014, FX101G2-VERS.032014, FX101G3, FX101G3C, FX101G3C-VERS.022014, FX101G3R, FX101G3R-VERS.022014, FX101G3-VERS.022014, FX10E2CR, FX10E2CR-VERS.032014, FX10E3CR, FX10E3CR-VERS.022014, FX10G2CR, FX10G2CR-VERS.032014, FX10G3CR, FX10G3CR-VERS.022014, FX122E1, FX122E2, FX122E2C, FX122E2T, FX122E2T-VERS.032014, FX122E3, FX122E3C, FX122E3T, FX122E3T-VERS.022014, FX122G1...(Otros modelos se puede ver en la tienda web)		



clemas



1

código	550232	referencia	32D1450
descripción	bornera 12 polos sección nominal 2.5mm ² máx. 32A máx. 450V resis.a la temp. 150°C		
Para modelos:	031FT04, 031FT06, 04WBMEV, 04WCP1EM, 04WFR3ED, 04WPE4V, 04WPEBV, 04WVT3RV, 06WBR3E, 06WFT1EV, 06WFT2EV, 06WFT3EV, 06WFT4EV, 06WFT6EV, 06WFT7EV, 070FT04, 070FT05, 071FT04, 071FT06, 08WFR4ED, 08WFT1EV, 08WFT2EV, 08WFT3EV, 08WFT4EV, 08WFT4GV, 08WFT6EV, 08WFT6GV, 08WFT7EV, 08WPE4V, 08WPEBV, 08WTPEV, 090BM1G, 090FT04, 090FT05, 090FT1G, 090FT2G, 090FT4G, 090FT5G, 090FT7G, 090GRG, 090PE4, 090VTR, 091CP1E, 091CP1G, 091FR1EA, 091FR1EX, 091FR3E, 091FR3ED, 091FT04, 091FT06...(Otros modelos se puede ver en la tienda web)		

regletas de bornes a tornillo



1

código	550507	referencia	32D1800
descripción	borne de conexión 4 polos máx. 40A máx. 400V empalme M6/M6 resis.a la temp. 150°C		

regletas de bornes con compensador de tracción



1

código	550951	referencia	32D0380
descripción	borne de conexión 3 polos sección nominal 2.5mm ² con compensador de tracción		
Para modelos:	030BME, 030EBM, 031BME, 031EBM, 090FAA, 090FAVA, 090GRG, 0M0BME, 0M0SP1E, 190FAA, 190FAB, 190GRG, 190TP0, 191FAAG, 191FABG, 191FADG, 191FAG, 191PD2G, 191PI1G, 191PI1GA, 191PI2G, 191PI2GA, 191TPG, 1G1FA0GV, 1MOBME, 291FAG, 291TPCG, 2G1FA0GV, 30F1, 30F1B, 30FS2, 30FS2B, 31TC, 32TC, 391FAG, 70F1, 70F1B, 71F2, 71F2B, 91F223B, G1FAGS, G1FAGST		

regletas de bornes a tornillo/con contactos de enchufe



1

código	550278	referencia	32D0171
descripción	borne de conexión 3 polos máx. 40A máx. 400V empalme ø6mm ² / F6,3 resis.a la temp. 150°C sección nominal 6mm ²		

regletas clemas enchufables



1

código	550950	referencia	32D0240
descripción	regleta clema enchufable 16 polos máx. 16A máx. 380V		



1

código	550349	referencia	32D1800
descripción	borne de conexión 4 polos máx. 40A máx. 400V empalme ø6mm ² / F6,3 resis.a la temp. 150°C sección nominal 6mm ²		

bloques de bornes

otros



1

código	550949	referencia	32D0480
descripción	borne seccionable amarillo/verde perfil C		
Para modelos:	030E, 030FE, 030FE1, 030FE1B, 030FTE, 030FTER, 031E, 031FTE, 031FTER, 031FTERL, 070BME, 070E, 070FTE, 070FTER, 071BME, 071E, 071FTE, 071FTER, 071FTERL, 090BME, 090E, 090FTE, 090FTER, 091BME, 091E, 091FE28, 091FE28B, 091FTE, 091FTER, 091FTERL, 30CPSE, 30FES, 30FES2, 30FES2B, 31GE, 31PIE6, 31RE, 70CPE, 70FE, 70FE1, 70FE1B, 70FES, 70FES2, 70FES2B, 71PIE15, 71PIE15A, 90CPE, 91PIE15, 91PIE15A, FS30E		



1

código	550411	referencia	32D0250 32D0251
descripción	borne de conexión 6 polos máx. 40A máx. 450V empalme ø6mm ² / F6,3 resis.a la temp. 150°C sección nominal 6mm ²		



1

código	550947	referencia	32D0470
descripción	borne seccionable perfil C		
Para modelos:	030E, 030FE, 030FE1, 030FE1B, 030FTE, 030FTE1, 030FTE2, 030FTE3, 030FTE4, 030FTE5, 030FTE6, 030FTE7, 030FTE8, 030FTE9, 030FTE10, 030FTE11, 030FTE12, 030FTE13, 030FTE14, 030FTE15, 030FTE16, 030FTE17, 030FTE18, 030FTE19, 030FTE20, 030FTE21, 030FTE22, 030FTE23, 030FTE24, 030FTE25, 030FTE26, 030FTE27, 030FTE28, 030FTE29, 030FTE30, 030FTE31, 030FTE32, 030FTE33, 030FTE34, 030FTE35, 030FTE36, 030FTE37, 030FTE38, 030FTE39, 030FTE40, 030FTE41, 030FTE42, 030FTE43, 030FTE44, 030FTE45, 030FTE46, 030FTE47, 030FTE48, 030FTE49, 030FTE50, 030FTE51, 030FTE52, 030FTE53, 030FTE54, 030FTE55, 030FTE56, 030FTE57, 030FTE58, 030FTE59, 030FTE60, 030FTE61, 030FTE62, 030FTE63, 030FTE64, 030FTE65, 030FTE66, 030FTE67, 030FTE68, 030FTE69, 030FTE70, 030FTE71, 030FTE72, 030FTE73, 030FTE74, 030FTE75, 030FTE76, 030FTE77, 030FTE78, 030FTE79, 030FTE80, 030FTE81, 030FTE82, 030FTE83, 030FTE84, 030FTE85, 030FTE86, 030FTE87, 030FTE88, 030FTE89, 030FTE90, 030FTE91, 030FTE92, 030FTE93, 030FTE94, 030FTE95, 030FTE96, 030FTE97, 030FTE98, 030FTE99, 030FTE100		

accesorios en general

bornes finales



1

código	550948	referencia	32D0490
descripción	barrera de aislamiento perfil C		
Para modelos:	030E, 030FE, 030FE1, 030FE1B, 030FTE, 030FTE1, 030FTE2, 030FTE3, 030FTE4, 030FTE5, 030FTE6, 030FTE7, 030FTE8, 030FTE9, 030FTE10, 030FTE11, 030FTE12, 030FTE13, 030FTE14, 030FTE15, 030FTE16, 030FTE17, 030FTE18, 030FTE19, 030FTE20, 030FTE21, 030FTE22, 030FTE23, 030FTE24, 030FTE25, 030FTE26, 030FTE27, 030FTE28, 030FTE29, 030FTE30, 030FTE31, 030FTE32, 030FTE33, 030FTE34, 030FTE35, 030FTE36, 030FTE37, 030FTE38, 030FTE39, 030FTE40, 030FTE41, 030FTE42, 030FTE43, 030FTE44, 030FTE45, 030FTE46, 030FTE47, 030FTE48, 030FTE49, 030FTE50, 030FTE51, 030FTE52, 030FTE53, 030FTE54, 030FTE55, 030FTE56, 030FTE57, 030FTE58, 030FTE59, 030FTE60, 030FTE61, 030FTE62, 030FTE63, 030FTE64, 030FTE65, 030FTE66, 030FTE67, 030FTE68, 030FTE69, 030FTE70, 030FTE71, 030FTE72, 030FTE73, 030FTE74, 030FTE75, 030FTE76, 030FTE77, 030FTE78, 030FTE79, 030FTE80, 030FTE81, 030FTE82, 030FTE83, 030FTE84, 030FTE85, 030FTE86, 030FTE87, 030FTE88, 030FTE89, 030FTE90, 030FTE91, 030FTE92, 030FTE93, 030FTE94, 030FTE95, 030FTE96, 030FTE97, 030FTE98, 030FTE99, 030FTE100		



1

código	550946	referencia	32D0060
descripción	borne final perfil C		
Para modelos:	030E, 030FE, 030FE1, 030FE1B, 030FTE, 030FTE1, 030FTE2, 030FTE3, 030FTE4, 030FTE5, 030FTE6, 030FTE7, 030FTE8, 030FTE9, 030FTE10, 030FTE11, 030FTE12, 030FTE13, 030FTE14, 030FTE15, 030FTE16, 030FTE17, 030FTE18, 030FTE19, 030FTE20, 030FTE21, 030FTE22, 030FTE23, 030FTE24, 030FTE25, 030FTE26, 030FTE27, 030FTE28, 030FTE29, 030FTE30, 030FTE31, 030FTE32, 030FTE33, 030FTE34, 030FTE35, 030FTE36, 030FTE37, 030FTE38, 030FTE39, 030FTE40, 030FTE41, 030FTE42, 030FTE43, 030FTE44, 030FTE45, 030FTE46, 030FTE47, 030FTE48, 030FTE49, 030FTE50, 030FTE51, 030FTE52, 030FTE53, 030FTE54, 030FTE55, 030FTE56, 030FTE57, 030FTE58, 030FTE59, 030FTE60, 030FTE61, 030FTE62, 030FTE63, 030FTE64, 030FTE65, 030FTE66, 030FTE67, 030FTE68, 030FTE69, 030FTE70, 030FTE71, 030FTE72, 030FTE73, 030FTE74, 030FTE75, 030FTE76, 030FTE77, 030FTE78, 030FTE79, 030FTE80, 030FTE81, 030FTE82, 030FTE83, 030FTE84, 030FTE85, 030FTE86, 030FTE87, 030FTE88, 030FTE89, 030FTE90, 030FTE91, 030FTE92, 030FTE93, 030FTE94, 030FTE95, 030FTE96, 030FTE97, 030FTE98, 030FTE99, 030FTE100		

componentes electrónicos

otros



1

código	400958	referencia	32Z5500
descripción	estabilizador electrónica L 80mm An 17mm H 45mm 180-260V consumo de corriente 3A 50/60Hz		
Para modelos:	030FE1, 091FE28, 30F1, 30FES2, 30FS2, 70F1, 70FE1, 70FES2, 71F2, 71FE2, 91F210		

grifos de gas

PEL

serie 20S



1

código	103179	referencia	33D3180
descripción	grifo de gas PEL tipo 20S entrada gas brida de tubo ø21mm boquilla bypass ø0mm salida gas M16x1,5 (tubo ø 10/8mm) conexión termopar M9x1 conexión de piloto eje ø 8x6,5mm eje L 22/15mm parte plana abajo sin conexión de llama piloto		
Para modelos:	G1FAGS, G1FAGST		



1



código	101068	referencia	33A0070 6004730
descripción	grifo de gas PEL tipo 20S entrada gas M16x1,5 (tubo ø 10mm) boquilla bypass ø 0.2mm salida gas 1/4" (tubo ø 6mm) conexión termopar M8x1 conexión de piloto eje ø 8x6,5mm eje L 22/15mm parte plana arriba kit de modificación tubo ø 10mm		
repuestos para	101068		







código	101060	referencia	32Z1520
descripción	grupo magnético estándar L 39mm D1 ø 15.4mm D2 ø 11mm apto para PEL20-21/JUNKERS/EGA		
código	101205	referencia	—
descripción	parte delantera de grifo de gas eje ø 8x6,5mm eje L 22/15mm parte plana arriba/abajo apto para PEL20		
código	101230	referencia	—
descripción	tuerca de termopar G1: M8x1 G2: M18x1 aluminio		
código	101278	referencia	36Q0080
descripción	anillo cortante para tubo ø 10mm UE 1 pzs		

Continúa en la página siguiente



repuestos para	101068			
	código	101300	referencia	36Q0830
	tuerca de racor rosca M16x1,5 tubo ø 10mm			
accesorios para	101068			
	código	110081	referencia	36M0770
	pomo ø 70mm eje ø 8x6,5mm parte plana universal			
	código	110083	referencia	—
	símbolo para pomo grifo de gas sin llama piloto plata			

accesorios para	109515			
	código	101450	referencia	—
	anillo cortante para tuboø 8mm L 12.7mm UE 1 pzs ø ext. 10mm			
	código	101451	referencia	—
	tuerca de racor rosca M16x1,5 tubo ø 8mm			
	código	110078	referencia	—
	pomo sin símbolo ø 70mm eje ø 6x4,6mm parte plana universal			
	código	112206	referencia	—
	símbolo para pomo plata grifo de gas PEL21/22/23 T máx°C ø ext. 63mm int.ø 45.5mm			

serie 215

				
1				
código	109515	referencia	3064310	
descripción	grifo de gas PEL tipo 215 entrada gas brida de tubo ø21mm boquilla bypass ø 0mm salida gas M16x1,5 (tubo ø 10/8mm) conexión termopar M8x1 conexión de piloto M10x1 eje ø 8x6,5mm eje L 22/15mm parte plana arriba			
Para modelos:	04WFAAV, 08WFA4E, 08WFA4G, 08WFAAE, 08WFAAG, 08WFAAV, 090FAA, 0G0FA0, 0G1CP1G-VERS.2004, 12WFA6E, 12WFA6G, 12WFAAA, 12WFAAE, 12WFAAG, 12WFAAN, 190FA, 190FAA, 190FAB, 190FAD, 191FAAE, 191FAAG, 191FABG, 191FADG, 191FAE, 191FAG, 1G0FA0, 1G0FA0B, 1G0GRG, 1G0TP0, 1G1CP1G-VERS.2004, 1G1CP2G-VERS.2004, 1G1FA0E, 1G1FA0EV, 1G1FA0G, 1G1FA0GV, 1G1FABG, 1G1FAPG, 1G1TP0G, 290FA, 291FAG, 291FAGF, 291TPCG, 2G0FA0, 2G0FA0A, 2G0FA0B, 2G1FA0E, 2G1FA0G, 2G1FA0GV, 2G1FABG, 2G1FACG...(Otros modelos se puede ver en la tienda web)			
repuestos para	109515			
	código	101060	referencia	32Z1520
	grupo magnético estándar L 39mm D1 ø 15.4mm D2 ø 11mm apto para PEL20-21/JUNKERS/EGA			
	código	101206	referencia	—
	parte delantera de grifo de gas eje ø 8x6,5mm eje L 22/15mm parte plana arriba/abajo apto para PEL21			
	código	101230	referencia	—
	tuerca de termopar G1: M8x1 G2: M18x1 aluminio			
accesorios para	109515			
	código	100908	referencia	36Q1000
	tornillo de racor rosca M10x1 para tuboø 4mm UE 1 pzs			
	código	100909	referencia	36Q0060
	tornillo de racor rosca M10x1 para tuboø 6mm UE 1 pzs			
	código	101246	referencia	—
	anillo cortante para tuboø 4mm UE 1 pzs			
	código	101278	referencia	36Q0080
	anillo cortante para tuboø 10mm UE 1 pzs			
	código	101286	referencia	36Q0020
	anillo cortante int.ø 6mm UE 1 pzs			
	código	101300	referencia	36Q0830
	tuerca de racor rosca M16x1,5 tubo ø 10mm			

				
1				
código	106231	referencia	33D1930	
descripción	grifo de gas PEL tipo 215 entrada gas brida de tubo ø21mm boquilla bypass ø 1.05mm salida gas M16x1,5 (tubo ø 10/8mm) conexión termopar M8x1 conexión de piloto M10x1 eje ø 8x6,5mm eje L 22/15mm parte plana abajo			
Para modelos:	0A0FA1, 0A0FA4, 0A0FAA, 0D0FA1, 0D0FA4, 0D0FAA, 0G0FA0, 0G1CP1G, 0G1CP1G-VERS.2004, 1A0FA1, 1A0FA2, 1A0FA4, 1A0FA5, 1A0FAA, 1A0FAB, 1A1FA1G, 1A1FA2G, 1A1FA4G, 1A1FA5G, 1A1FAAG, 1A1FABG, 1D0FA1, 1D0FA2, 1D0FA4, 1D0FA5, 1D0FAA, 1D0FAB, 1D1FA1G, 1D1FA2G, 1D1FA4G, 1D1FA5G, 1D1FAAG, 1D1FABG, 1G0FA0, 1G0GRG, 1G0TP0, 1G1CP1G, 1G1CP1G-VERS.2004, 1G1CP2G, 1G1CP2G-VERS.2004, 1G1FA0E, 1G1FA0EV, 1G1FA0G, 1G1FA0GV, 1G1FAPG, 1G1TP0G, 2A0FA1, 2A0FA4, 2A0FAA, 2A1FA1G...(Otros modelos se puede ver en la tienda web)			
repuestos para	106231			
	código	100557	referencia	33T3670
	boquilla bypass tipo PEL20/21 taladro ø 1.05mm rosca M5x0,5			
	código	101060	referencia	32Z1520
	grupo magnético estándar L 39mm D1 ø 15.4mm D2 ø 11mm apto para PEL20-21/JUNKERS/EGA			
	código	101230	referencia	—
	tuerca de termopar G1: M8x1 G2: M18x1 aluminio			
	código	101880	referencia	—
	junta Viton ø ext. 14mm int.ø 9mm espesor 7.7mm UE 1 pzs			
accesorios para	106231			
	código	101277	referencia	36Q1630
	anillo cortante int.ø 8mm UE 1 pzs			
	código	101278	referencia	36Q0080
	anillo cortante para tuboø 10mm UE 1 pzs			
	código	101300	referencia	36Q0830
	tuerca de racor rosca M16x1,5 tubo ø 10mm			
	código	101451	referencia	—
	tuerca de racor rosca M16x1,5 tubo ø 8mm			









1			
código	101095	referencia	33D1170
descripción	grifo de gas PEL tipo 21S entrada gas M16x1,5 (tubo ø 10mm) boquilla bypass ø 0.35mm salida gas M16x1,5 (tubo ø 10/8mm) conexión termopar M8x1 conexión de piloto M10x1 eje ø 8x6,5mm eje L 22/15mm parte plana abajo		
Para modelos:	030, 031, 032, 31, 31GE, 31TC, 32, 32TC, 32TP, 32TPV, 32V, 60SM		
repuestos para	101095		
	código	100408	referencia 33T3630
	boquilla bypass tipo PEL20/21 taladro ø 0.35mm rosca M5x0,5		
	código	101060	referencia 32Z1520
	grupo magnético estándar L 39mm D1 ø 15.4mm D2 ø 11mm apto para PEL20-21/JUNKERS/EGA		
	código	101206	referencia —
	parte delantera de grifo de gas eje ø 8x6,5mm eje L 22/15mm parte plana arriba/abajo apto para PEL21		
	código	101230	referencia —
	tuerca de termopar G1: M8x1 G2: M18x1 aluminio		
accesorios para	101095		
	código	100908	referencia 36Q1000
	tornillo de racor rosca M10x1 para tubo ø 4mm UE 1 pzs		
	código	100909	referencia 36Q0060
	tornillo de racor rosca M10x1 para tubo ø 6mm UE 1 pzs		
	código	101246	referencia —
	anillo cortante para tubo ø 4mm UE 1 pzs		
	código	101278	referencia 36Q0080
	anillo cortante para tubo ø 10mm UE 1 pzs		
	código	101286	referencia 36Q0020
	anillo cortante int.ø 6mm UE 1 pzs		
	código	101300	referencia 36Q0830
	tuerca de racor rosca M16x1,5 tubo ø 10mm		
	código	101450	referencia —
	anillo cortante para tubo ø 8mm L 12.7mm UE 1 pzs ø ext. 10mm		
	código	101451	referencia —
	tuerca de racor rosca M16x1,5 tubo ø 8mm		
	código	110081	referencia 36M0770
	pomo ø 70mm eje ø 8x6,5mm parte plana universal		
	código	112206	referencia —
	símbolo para pomo plata grifo de gas PEL21/22/23 T máx°C ø ext. 63mm int.ø 45.5mm		

serie 22N/O

1			
código	106234	referencia	33A0090
descripción	grifo de gas PEL tipo 22N/O entrada gas M20x1,5 (tubo ø 12mm) boquilla bypass ø 0.35mm salida gas M20x1,5 (tubo abocardado ø 12/10mm) conexión termopar conexión de piloto M10x1 eje ø 10x8mm eje L 28/13mm parte plana abajo		
repuestos para	106234		
	código	100259	referencia 33T1180
	boquilla bypass tipo PEL22 taladro ø 0.35mm rosca M6x0,5		
	código	101203	referencia —
	parte delantera de grifo de gas eje ø 9x10mm eje L 28/13mm parte plana arriba/abajo apto para PEL22		
	código	101240	referencia —
	empalme de gas rosca M20x1.5 tubo ø 12/10mm para grifos de gas PEL con junta y tronillos horizontal		
	código	101331	referencia —
	adaptador apto para PEL22 para tubo abocardado 10/12mm		
	código	101460	referencia —
	junta tórica ø 12.37mm D1 ø 2.62mm apto para PEL22		
	código	101461	referencia —
	tornillo Kit apto para PEL22 UE 4 pzs		
accesorios para	106234		
	código	100908	referencia 36Q1000
	tornillo de racor rosca M10x1 para tubo ø 4mm UE 1 pzs		
	código	100909	referencia 36Q0060
	tornillo de racor rosca M10x1 para tubo ø 6mm UE 1 pzs		
	código	101246	referencia —
	anillo cortante para tubo ø 4mm UE 1 pzs		
	código	101248	referencia 36Q0030
	anillo cortante para tubo ø 12mm UE 1 pzs apto para PEL		
	código	101249	referencia 36Q1700
	anillo cortante para tubo ø 10mm UE 1 pzs		
	código	101250	referencia 36Q0610
	tuerca de racor rosca M20x1.5 para ø de tubo 10mm		
	código	101251	referencia 36Q0050
	tuerca de racor rosca M20x1.5 para ø de tubo 12mm		
	código	101286	referencia 36Q0020
	anillo cortante int.ø 6mm UE 1 pzs		



			
código	106233	referencia	33A1110
descripción	grifo de gas PEL tipo 22N/O entrada gas M20x1,5 (tubo ø 12mm) boquilla bypass ø 0.35mm salida gas M20x1,5 (tubo ø 12/10mm) conexión termopar conexión de piloto M10x1 eje ø 10x8mm eje L 28/13mm parte plana abajo		
repuestos para	106233		
	código	referencia	100259 33T1180
	boquilla bypass tipo PEL22 taladro ø 0.35mm rosca M6x0,5		
	código	referencia	101203 —
	parte delantera de grifo de gas eje ø 9x10mm eje L 28/13mm parte plana arriba/abajo apto para PEL22		
	código	referencia	101240 —
	empalme de gas rosca M20x1.5 tubo ø 12/10mm para grifos de gas PEL con junta y tronillos horizontal		
	código	referencia	101460 —
	junta tórica ø 12.37mm D1 ø 2.62mm apto para PEL22		
	código	referencia	101461 —
	tornillo Kit apto para PEL22 UE 4 pzs		
accesorios para	106233		
	código	referencia	100908 36Q1000
	tornillo de racor rosca M10x1 para tubo ø 4mm UE 1 pzs		
	código	referencia	100909 36Q0060
	tornillo de racor rosca M10x1 para tubo ø 6mm UE 1 pzs		
	código	referencia	101246 —
	anillo cortante para tubo ø 4mm UE 1 pzs		
	código	referencia	101248 36Q0030
	anillo cortante para tubo ø 12mm UE 1 pzs apto para PEL		
	código	referencia	101249 36Q1700
	anillo cortante para tubo ø 10mm UE 1 pzs		
	código	referencia	101250 36Q0610
	tuerca de racor rosca M20x1.5 para ø de tubo 10mm		
	código	referencia	101251 36Q0050
	tuerca de racor rosca M20x1.5 para ø de tubo 12mm		
	código	referencia	101286 36Q0020
	anillo cortante int. ø 6mm UE 1 pzs		

serie 22S/O			
			
código	101085	referencia	33A0100 33A1040
descripción	grifo de gas PEL tipo 22S/O entrada gas M20x1,5 (tubo ø 12mm) boquilla bypass ø 0.35mm salida gas M20x1,5 (tubo abocardado ø12/10mm) conexión termopar M8x1 conexión de piloto M10x1 eje ø 10x9mm eje L 28/13mm parte plana arriba		
Para modelos:	031TP, 070D, 070DGG, 070FT, 070FTR, 0712D, 0712VA, 071D, 071DGG, 071FT, 071FTR, 071FTRL, 071TP, 072D, 072DGG, 090, 090FT, 090FTR, 090GG, 091, 091FT, 091FTR, 091FTRL, 091GG, 091TP, 092, 092GG, 092VA, 092VAGG, 30CPS, 31PD6, 31PI6, 31TP, 32TP, 32TPV, 70CP, 712D, 712VA, 71CP, 71CP2, 71D, 71DGG, 71GE, 71GEGG, 71PD10, 71PD15, 71PI10, 71PI10A, 71TP, 72D...(Otros modelos se puede ver en la tienda web)		
repuestos para	101085		
	código	referencia	100259 33T1180
	boquilla bypass tipo PEL22 taladro ø 0.35mm rosca M6x0,5		
	código	referencia	101058 32Z1460
	grupo magnético L 39mm D1 ø 15.4mm D2 ø 13.5mm apto para PEL22/EGA24197 estándar		
	código	referencia	101203 —
	parte delantera de grifo de gas eje ø 9x10mm eje L 28/13mm parte plana arriba/abajo apto para PEL22		
	código	referencia	101230 —
	tuerca de termopar G1: M8x1 G2: M18x1 aluminio		
	código	referencia	101240 —
	empalme de gas rosca M20x1.5 tubo ø 12/10mm para grifos de gas PEL con junta y tronillos horizontal		
	código	referencia	101460 —
	junta tórica ø 12.37mm D1 ø 2.62mm apto para PEL22		
	código	referencia	101461 —
	tornillo Kit apto para PEL22 UE 4 pzs		
accesorios para	101085		
	código	referencia	100908 36Q1000
	tornillo de racor rosca M10x1 para tubo ø 4mm UE 1 pzs		
	código	referencia	100909 36Q0060
	tornillo de racor rosca M10x1 para tubo ø 6mm UE 1 pzs		
	código	referencia	101241 —
	empalme de gas rosca M20x1.5 tubo ø 12/10mm para grifos de gas PEL vertical		
	código	referencia	101246 —
	anillo cortante para tubo ø 4mm UE 1 pzs		
	código	referencia	101248 36Q0030
	anillo cortante para tubo ø 12mm UE 1 pzs apto para PEL		
	código	referencia	101249 36Q1700
	anillo cortante para tubo ø 10mm UE 1 pzs		

Continúa en la página siguiente



accesorios para		101085	
	código	101250	referencia 36Q0610
	tuerca de racor rosca M20x1.5 para ø de tubo 10mm		
	código	101251	referencia 36Q0050
	tuerca de racor rosca M20x1.5 para ø de tubo 12mm		
	código	101286	referencia 36Q0020
	anillo cortante int.ø 6mm UE 1 pzs		
	código	101331	referencia —
	adaptador apto para PEL22 para tubo abocardado 10/12mm		
	código	110140	referencia 36M2390 36M5140
	pomo interruptor marca cero ø 67mm eje ø 10x9mm parte plana arriba negro		

serie 22S/V



1

código		101457		referencia		33A0580	
descripción		grifo de gas alternativa a JUNKERS tipo CH110 entrada gas M20x1,5 (tubo ø 12mm) boquilla bypass ø 0.35mm salida gas M20x1,5 (tubo ø 12/10mm) conexión termopar M8x1 conexión de piloto M10x1 eje ø 10mm eje L 25mm parte plana con salida para tubo					
repuestos para		101457					
	código	100259	referencia	33T1180			
	boquilla bypass tipo PEL22 taladro ø 0.35mm rosca M6x0,5						
	código	100908	referencia	36Q1000			
	tornillo de racor rosca M10x1 para tuboø 4mm UE 1 pzs						
	código	101058	referencia	32Z1460			
	grupo magnético L 39mm D1 ø 15.4mm D2 ø 13.5mm apto para PEL22/EGA24197 estándar						
	código	101200	referencia	—			
	parte delantera de grifo de gas eje ø 10mm eje L 25mm parte plana apto para 22S/O						
	código	101230	referencia	—			
	tuerca de termopar G1: M8x1 G2: M18x1 aluminio						
	código	101241	referencia	—			
	empalme de gas rosca M20x1.5 tubo ø 12/10mm para grifos de gas PEL vertical						
	código	101246	referencia	—			
	anillo cortante para tuboø 4mm UE 1 pzs						
	código	101460	referencia	—			
	junta tórica ø 12.37mm D1 ø 2.62mm apto para PEL22						
	código	101461	referencia	—			
	tornillo Kit apto para PEL22 UE 4 pzs						

accesorios para		101457	
	código	100945	referencia —
	pasador elástico ø 3.2mm L 10mm		
	código	101218	referencia —
	alargador de eje JUNKERS		
	código	101219	referencia —
	alargador de eje L 25mm JUNKERS		
	código	101231	referencia —
	tuerca de termopar G1: M9x1 G2: M18x1		
	código	101248	referencia 36Q0030
	anillo cortante para tuboø 12mm UE 1 pzs apto para PEL		
	código	101249	referencia 36Q1700
	anillo cortante para tuboø 10mm UE 1 pzs		
	código	101250	referencia 36Q0610
	tuerca de racor rosca M20x1.5 para ø de tubo 10mm		
	código	101251	referencia 36Q0050
	tuerca de racor rosca M20x1.5 para ø de tubo 12mm		
	código	101290	referencia —
	tuerca de termopar G1: M10x1 G2: M18x1 apto para PEL20/21		
	código	110064	referencia 36M0660
	pomo		
	código	110066	referencia —
	tornillo de pomo		
	código	550396	referencia —
	alargador de eje L 25mm JUNKERS		

1

código		101661		referencia		33D1990 33D1991	
descripción		grifo de gas PEL tipo 22S/V entrada gas brida de tubo ø21mm boquilla bypass ø 0.35mm salida gas M20x1,5 (tubo ø 12/10mm) conexión termopar M8x1 conexión de piloto M10x1 eje ø 10x8,5mm eje L 28/13mm parte plana arriba					
Para modelos:		06WCP1GM, 08WCP1GM, 08WGRGV, 090FAVA, 090GRG, 091CP1G, 0A0FAS, 0A0FAVA, 0A0GRG, 0A1CP1G, 0B0FAS, 0B1CP1G, 0D0FAS, 0D0FAVA, 0D0GRG, 0D1CP1G, 10WTPGE, 10WTPGV, 190FAB, 190GRG, 190TPO, 191CP1G, 191CP2G, 191FABG, 191PD2G, 191PI1G, 191PI1GA, 191PI2G, 191PI2GA, 191TPG, 1A0FA2, 1A0FA5, 1A0FAB, 1A0FAS, 1A0FAS2, 1A0GRG, 1A0TPO, 1A1CP1G, 1A1CP2G, 1A1FA2G, 1A1FA5G, 1A1FABG, 1A1FAS2G, 1A1FASG, 1A1PD1G, 1A1PD2G, 1A1PI1G, 1A1PI1GA, 1A1TPOG, 1A1TPOG-VERS.2002...(Otros modelos se puede ver en la tienda web)					
repuestos para		101661					
	código	100259	referencia	33T1180			
	boquilla bypass tipo PEL22 taladro ø 0.35mm rosca M6x0,5						

Continúa en la página siguiente



repuestos para	101661		
	código	101058	referencia 32Z1460
	grupo magnético L 39mm D1 ø 15.4mm D2 ø 13.5mm apto para PEL22/EGA24197 estándar		
	código	101203	referencia —
	parte delantera de grifo de gas eje ø 9x10mm eje L 28/13mm parte plana arriba/abajo apto para PEL22		
	código	101230	referencia —
	tuerca de termopar G1: M8x1 G2: M18x1 aluminio		
	código	101237	referencia —
	brida rosca M20x1.5 tubo ø 21mm apto para PEL22		
	código	101241	referencia —
	empalme de gas rosca M20x1.5 tubo ø 12/10mm para grifos de gas PEL vertical		
	código	101460	referencia —
	junta tórica ø 12.37mm D1 ø 2.62mm apto para PEL22		
	código	101461	referencia —
	tornillo Kit apto para PEL22 UE 4 pzs		
	código	101536	referencia —
	junta D1 ø 17mm D2 ø 11.5mm espesor 4.7mm		
accesorios para	101661		
	código	100908	referencia 36Q1000
	tornillo de racor rosca M10x1 para tubo ø 4mm UE 1 pzs		
	código	100909	referencia 36Q0060
	tornillo de racor rosca M10x1 para tubo ø 6mm UE 1 pzs		
	código	101246	referencia —
	anillo cortante para tubo ø 4mm UE 1 pzs		
	código	101248	referencia 36Q0030
	anillo cortante para tubo ø 12mm UE 1 pzs apto para PEL		
	código	101249	referencia 36Q1700
	anillo cortante para tubo ø 10mm UE 1 pzs		
	código	101250	referencia 36Q0610
	tuerca de racor rosca M20x1.5 para ø de tubo 10mm		
	código	101251	referencia 36Q0050
	tuerca de racor rosca M20x1.5 para ø de tubo 12mm		
	código	101286	referencia 36Q0020
	anillo cortante int. ø 6mm UE 1 pzs		

serie 23S/O



1

código	109107	referencia	33A1530
descripción	grifo de gas PEL tipo 23S/O entrada gas M28x1,5 (tubo ø 20mm) boquilla bypass ø 0mm salida gas M24x1,5 (tubo ø 16mm) conexión termopar M9x1 conexión de piloto M10x1 eje ø 10x8mm eje L 35/19mm parte plana arriba		
Para modelos:	191CP1GA, 1A1CP1GA, 1A1PI2G, 1A1PI2GA, 1D1CP1GA, 1D1PI2G, 1D1PI2GA, 291PD3G, 291PI3G, 2A1PD3G, 2A1PI3G, 2D1PI3G, MCF20, MCF40		

compatible JUNKERS



1

código	101457	referencia	33A0580
descripción	grifo de gas alternativa a UNKERS tipo CH110 entrada gas M20x1,5 (tubo ø 12mm) boquilla bypass ø 0.35mm salida gas M20x1,5 (tubo ø 12/10mm) conexión termopar M8x1 conexión de piloto M10x1 eje ø 10mm eje L 25mm parte plana con salida para tubo		
repuestos para	101457		
	código	100259	referencia 33T1180
	boquilla bypass tipo PEL22 taladro ø 0.35mm rosca M6x0,5		
	código	100908	referencia 36Q1000
	tornillo de racor rosca M10x1 para tubo ø 4mm UE 1 pzs		
	código	101058	referencia 32Z1460
	grupo magnético L 39mm D1 ø 15.4mm D2 ø 13.5mm apto para PEL22/EGA24197 estándar		
	código	101200	referencia —
	parte delantera de grifo de gas eje ø 10mm eje L 25mm parte plana apto para 22S/O		
	código	101230	referencia —
	tuerca de termopar G1: M8x1 G2: M18x1 aluminio		
	código	101241	referencia —
	empalme de gas rosca M20x1.5 tubo ø 12/10mm para grifos de gas PEL vertical		
	código	101246	referencia —
	anillo cortante para tubo ø 4mm UE 1 pzs		
	código	101460	referencia —
	junta tórica ø 12.37mm D1 ø 2.62mm apto para PEL22		
	código	101461	referencia —
	tornillo Kit apto para PEL22 UE 4 pzs		

Continúa en la página siguiente



accesorios para	101457			
	código	100945	referencia	—
	pasador elástico ø 3.2mm L 10mm			
	código	101218	referencia	—
	alargador de eje JUNKERS			
	código	101219	referencia	—
	alargador de eje L 25mm JUNKERS			
	código	101231	referencia	—
	tuerca de termopar G1: M9x1 G2: M18x1			
	código	101248	referencia	36Q0030
	anillo cortante para tuboø 12mm UE 1 pzs apto para PEL			
	código	101249	referencia	36Q1700
	anillo cortante para tuboø 10mm UE 1 pzs			
	código	101250	referencia	36Q0610
	tuerca de racor rosca M20x1.5 para ø de tubo 10mm			
	código	101251	referencia	36Q0050
	tuerca de racor rosca M20x1.5 para ø de tubo 12mm			
	código	101290	referencia	—
	tuerca de termopar G1: M10x1 G2: M18x1 apto para PEL20/21			
	código	110064	referencia	36M0660
	pomo			
	código	110066	referencia	—
	tornillo de pomo			
	código	550396	referencia	—
	alargador de eje L 25mm JUNKERS			

termostatos para gas

SIT







serie 630 Eurosit















código	107688	referencia	3315970
descripción	termostato de gas 100-340°C entrada gas 3/8" salida gas 3/8" conexión termopar M9x1 conexión de piloto M10x1 sonda ø 4mm sonda L 72mm capilar 1050mm		

			
código	107846	referencia	6300641
descripción	termostato de gas tipo EUROSIT 80-320°C entrada gas 3/8" salida gas 3/8" conexión termopar M9x1 conexión de piloto M10x1 sonda L 72mm capilar 980mm SIT		
Para modelos:	1A1FAS2G, 1A1FASG, 1A1TP0G, 1D1FAS2G, 1D1FASG, 1D1TP0G, 2A1FAS2G, 2A1FASG, 2A1TPSG, 2D1FAS2G, 2D1FASG, 2D1TPSG, 3A1FASG, 3D1FASG		

			
código	103310	referencia	3041750
descripción	termostato de gas tipo serie 630 Eurosit 110-190°C		
Para modelos:	0G0FR5G, 0G1FR7G, 1G0FR6G, 1G1FR8G		

				
código	101413	referencia	33A0491 6300478	
descripción	termostato de gas tipo serie 630 Eurosit T máx 100°C 30-100°C entrada gas 3/8" salida gas 3/8" conexión termopar M9x1 conexión de piloto M10x1 sonda ø 5mm sonda L 122mm capilar 1050mm SIT			
Para modelos:	0A0BMG, 0D0BMG, 1A0BMG, 1D0BMG			
accesorios para	101413			
	código	100904	referencia	—
	tornillo de apriete M10x1 para tuboø 4mm UE 1 pzs			
	código	100905	referencia	—
	tornillo de apriete M10x1 para tuboø 6mm UE 1 pzs			
	código	101273	referencia	—
	anillo cortante para tuboø 12mm L 9.5mm latón UE 1 pzs apto para universal			
	código	101276	referencia	36Q0710
	tornillo de racor rosca 3/8" tubo ø 12mm UE 1 pzs			
	código	101333	referencia	36R0010
	tapón rosca 3/8" con junta tórica			



			
código	101915	referencia	33A0941
descripción	termostato de gas tipo serie 630 Eurosit T máx 320°C 80-320°C entrada gas 3/8" salida gas 3/8" conexión termopar M9x1 conexión de piloto M10x1 sonda ø 4mm sonda L 72mm capilar 1050mm SIT		
Para modelos:	1A1FAS2G, 1A1FASG, 1A1TP0G, 1D1FAS2G, 1D1FASG, 1D1TP0G, 2A1FAS2G, 2A1FASG, 2A1TPSG, 2D1FAS2G, 2D1FASG, 2D1TPSG, 3A1FASG, 3D1FASG		
accesorios para	101915		
	código	100825	referencia 33Q3480
	eje de grifo de gas eje ø 8x6,5mm eje L 22/14mm apto para EUROSIT		
	código	100904	referencia —
	tornillo de apriete M10x1 para tuboø 4mm UE 1 pzs		
	código	100905	referencia —
	tornillo de apriete M10x1 para tuboø 6mm UE 1 pzs		
	código	100949	referencia 3152280
	junta apto para serie 630 Eurosit		
	código	101273	referencia —
	anillo cortante para tuboø 12mm L 9.5mm latón UE 1 pzs apto para universal		
	código	101276	referencia 36Q0710
	tornillo de racor rosca 3/8" tubo ø 12mm UE 1 pzs		
	código	101333	referencia 36R0010
	tapón rosca 3/8" con junta tórica		
	código	101390	referencia —
	eje de grifo de gas eje ø 6x4,6mm eje L 32/15mm grifo de gas con llama piloto apto para ZANUSSI, MARENO para termostato de gas EUROSIT		
	código	101392	referencia 33A0920
	adaptador apto para serie 630 Eurosit		
	código	110357	referencia —
	eje de grifo de gas eje ø 8x6,5mm eje L 36/12mm apto para serie 630 Eurosit		
	código	110358	referencia —
	adaptador eje ø 10x8mm eje L 29/18mm apto para serie 630 Eurosit		

			
código	106164	referencia	3041720 6018970
descripción	termostato de gas tipo serie 630 Eurosit T máx 340°C 100-340°C entrada gas 3/8" salida gas 3/8" conexión termopar M9x1 conexión de piloto M10x1 sonda ø 4mm sonda L 72mm capilar 1050mm regulador de presión 13-18mbar temperatura ambiente máx. 0-120°C		
Para modelos:	08WFA4G, 08WFAAG, 08WFT1GV, 08WFT2GV, 08WFT3GV, 08WFT-7GV, 090FT1G, 090FT2G, 090FT4G, 090FT5G, 090FT7G, 0G0FT1G-VERS.032008, 0G0FT2G-VERS.032008, 0G0FT7G, 0G1BR3G, 12WFA6G, 12WFAAG, 190FT15G, 190FT1G, 190FT2G, 190FT3G, 190FT42G, 190FT4G, 190FT6G, 190FT72G, 190FT7G, 191FAAG, 191FABG, 191FADG, 191FAG, 191TPG, 1A1FA1G, 1A1FA2G, 1A1FA4G, 1A1FA5G, 1A1FAAG, 1A1FABG, 1A1TP0G-VERS.2002, 1B1FAS2G, 1B1FASG, 1D1FA1G, 1D1FA2G, 1D1FA4G, 1D1FA5G, 1D1FAAG, 1D1FABG, 1D1TP0G-VERS.2002, 1G0FT1G-VERS.032008, 1G0FT2G-VERS.032008, 1G0FT3G-VERS.032008...(Otros modelos se puede ver en la tienda web)		
accesorios para	106164		
	código	100904	referencia —
	tornillo de apriete M10x1 para tuboø 4mm UE 1 pzs		
	código	100905	referencia —
	tornillo de apriete M10x1 para tuboø 6mm UE 1 pzs		
	código	101273	referencia —
	anillo cortante para tuboø 12mm L 9.5mm latón UE 1 pzs apto para universal		
	código	101276	referencia 36Q0710
	tornillo de racor rosca 3/8" tubo ø 12mm UE 1 pzs		
	código	101333	referencia 36R0010
	tapón rosca 3/8" con junta tórica		



código	101125	referencia	33A0570 33A0571
descripción	termostato de gas tipo serie 630 Eurosit T máx 340°C 100-340°C entrada gas 3/8" salida gas 3/8" conexión termopar M9x1 conexión de piloto M10x1 sonda ø 4mm sonda L 72mm capilar 1050mm SIT		
Para modelos:	08WFAAG, 0G1BR3G, 12WFAAG, 1A1FA1G, 1A1FA2G, 1A1FA4G, 1A1FA5G, 1A1FAAG, 1A1FABG, 1A1TP0G-VERS.2002, 1B1FAS2G, 1B1FASG, 1D1FA1G, 1D1FA2G, 1D1FA4G, 1D1FA5G, 1D1FAAG, 1D1FABG, 1D1TP0G-VERS.2002, 1G1BR3G, 2A1FA1G, 2A1FA4G, 2A1FAAG, 2A1TP3G, 2A1TP6G, 2A1TPCG, 2D1FA1G, 2D1FA4G, 2D1FAAG, 2D1TP3G, 2D1TP6G, 2D1TPCG, 3A1FA1G, 3A1FA4G, 3A1FAAG, 3D1FA1G, 3D1FA4G, 3D1FAAG		
accesorios para	101125		
	código	100825	referencia 33Q3480
eje de grifo de gas eje ø 8x6,5mm eje L 22/14mm apto para EUROSIT			
	código	100904	referencia —
tornillo de apriete M10x1 para tubo ø 4mm UE 1 pzs			
	código	100905	referencia —
tornillo de apriete M10x1 para tubo ø 6mm UE 1 pzs			
	código	100949	referencia 3152280
junta apto para serie 630 Eurosit			
	código	101273	referencia —
anillo cortante para tubo ø 12mm L 9.5mm latón UE 1 pzs apto para universal			
	código	101276	referencia 36Q0710
tornillo de racor rosca 3/8" tubo ø 12mm UE 1 pzs			
	código	101333	referencia 36R0010
tapón rosca 3/8" con junta tórica			
	código	101390	referencia —
eje de grifo de gas eje ø 6x4,6mm eje L 32/15mm grifo de gas con llama piloto apto para ZANUSSI, MARENO para termostato de gas EUROSIT			
	código	101392	referencia 33A0920
adaptador apto para serie 630 Eurosit			
	código	110357	referencia —
eje de grifo de gas eje ø 8x6,5mm eje L 36/12mm apto para serie 630 Eurosit			
	código	110358	referencia —
adaptador eje ø 10x8mm eje L 29/18mm apto para serie 630 Eurosit			



código	101971	referencia	6300479
descripción	termostato de gas tipo serie 630 Eurosit T máx 340°C 100-340°C SIT		
repuestos para	101971		
	código	100825	referencia 33Q3480
eje de grifo de gas eje ø 8x6,5mm eje L 22/14mm apto para EUROSIT			
	código	101392	referencia 33A0920
adaptador apto para serie 630 Eurosit			
accesorios para	101971		
	código	100825	referencia 33Q3480
eje de grifo de gas eje ø 8x6,5mm eje L 22/14mm apto para EUROSIT			
	código	100904	referencia —
tornillo de apriete M10x1 para tubo ø 4mm UE 1 pzs			
	código	100905	referencia —
tornillo de apriete M10x1 para tubo ø 6mm UE 1 pzs			
	código	100949	referencia 3152280
junta apto para serie 630 Eurosit			
	código	101273	referencia —
anillo cortante para tubo ø 12mm L 9.5mm latón UE 1 pzs apto para universal			
	código	101276	referencia 36Q0710
tornillo de racor rosca 3/8" tubo ø 12mm UE 1 pzs			
	código	101333	referencia 36R0010
tapón rosca 3/8" con junta tórica			
	código	101390	referencia —
eje de grifo de gas eje ø 6x4,6mm eje L 32/15mm grifo de gas con llama piloto apto para ZANUSSI, MARENO para termostato de gas EUROSIT			
	código	101392	referencia 33A0920
adaptador apto para serie 630 Eurosit			
	código	110357	referencia —
eje de grifo de gas eje ø 8x6,5mm eje L 36/12mm apto para serie 630 Eurosit			
	código	110358	referencia —
adaptador eje ø 10x8mm eje L 29/18mm apto para serie 630 Eurosit			





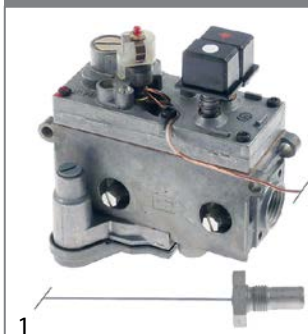



serie 710 Minisit



código	101114 ¹	referencia	33A1370 6000480
descripción	termostato de gas con regulador de presión SIT tipo MINISIT 710 T máx 190°C 110-190°C entrada gas 1/2" salida gas 3/8" conexión termopar M9x1 conexión de piloto M10x1 sonda ø 10.5mm sonda L 26mm capilar 1050mm tipo de sensor tipo F3 regulador de presión presente regulador de presión 3-18mbar prensaestopas		
Para modelos:	30F, 30FS, 70F, 71F		
repuestos para	101114		
	código	101053	referencia 32Z1490
	grupo magnético G1: M9x1 G2: M24x1 L 45mm ø 17mm apto para Minisit		
	código	102104	referencia —
	sensor 110-190°C sonda ø 11mm rosca sonda 1/4" sonda L 26mm capilar 1050mm T máx 190°C freidora tipo de sensor tipo F3 apto para MINISIT 710		
accesorios para	101114		
	código	100809	referencia —
	junta tórica EPDM espesor 2mm int.ø 21mm UE 1 pzs		
	código	100820	referencia —
	conducción para prensaestopas M M14x1,5 H M10x0,75 sonda ø máx. 6.5mm EC 22		
	código	100904	referencia —
	tornillo de apriete M10x1 para tuboø 4mm UE 1 pzs		
	código	100905	referencia —
	tornillo de apriete M10x1 para tuboø 6mm UE 1 pzs		
	código	101054	referencia —
	grupo magnético G1: M10x1 G2: M24x1 L 45mm ø 17mm apto para Minisit		
	código	101136	referencia —
	encendedor piezoeléctrico apto para Minisit con tapa ømm empalme F6,3x0,8		
	código	101137	referencia —
	tapa sin piezoencendedor		
	código	101267	referencia —
	reducción H 3/8" M 1/2" L 21mm		
	código	101268	referencia —
	empalme de gas rosca 3/8" acodado con junta tórica MINISIT 710		
	código	101269	referencia —
	empalme de gas rosca 1/2" acodado con junta tórica MINISIT 710		
	código	101270	referencia —
	unión roscada H 3/8" M 3/8" L 28mm		



¹rosca de sonda 1/4"







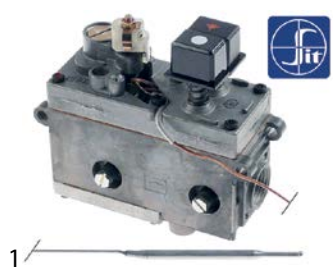









accesorios para	101114		
	código	101272	referencia —
	unión roscada H 1/2" M 3/8" L 57mm		
	código	101273	referencia —
	anillo cortante para tuboø 12mm L 9.5mm latón UE 1 pzs apto para universal		
	código	101274	referencia —
	anillo cortante para tuboø 16mm UE 1 pzs		
	código	101275	referencia —
	tornillo de racor rosca 1/2" para tuboø 16mm UE 1 pzs		
	código	101276	referencia 36Q0710
	tornillo de racor rosca 3/8" tubo ø 12mm UE 1 pzs		
	código	110068	referencia 36M0950
	pomo apto para Minisit ø 37mm		
	código	361182	referencia 3117580
	tuerca rosca 1/4" H 5mm latón niquelado EC 17 UE 1 pzs		
	código	532520	referencia 3150390
	junta tórica silicona espesor 2.62mm int.ø 15.08mm UE 1 pzs		

	código	101432	referencia 32Z0360 33A0800
descripción	termostato de gas con tecla SIT tipo MINISIT 710 T máx 90°C 30-90°C entrada gas 1/2" salida gas 1/2" conexión termopar M9x1 conexión de piloto M10x1 sonda ø 8mm sonda L 100mm capilar 1050mm tipo de sensor tipo E2 regulador de presión presente regulador de presión 3-18mbar prensaestopas		
repuestos para	101432		
	código	100809	referencia —
	junta tórica EPDM espesor 2mm int.ø 21mm UE 1 pzs		
	código	100905	referencia —
	tornillo de apriete M10x1 para tuboø 6mm UE 1 pzs		
	código	101053	referencia 32Z1490
	grupo magnético G1: M9x1 G2: M24x1 L 45mm ø 17mm apto para Minisit		
	código	101269	referencia —
	empalme de gas rosca 1/2" acodado con junta tórica MINISIT 710		
	código	102117	referencia —
	sensor 30-90°C sonda ø 8mm sonda L 100mm capilar 1050mm T máx 90°C baño maría tipo de sensor tipo E2 apto para MINISIT 710		
	código	110068	referencia 36M0950
	pomo apto para Minisit ø 37mm		

Continúa en la página siguiente

accesorios para		101432	
	código	100904	referencia —
tornillo de apriete M10x1 para tubo ø 4mm UE 1 pzs			
	código	101054	referencia —
grupo magnético G1: M10x1 G2: M24x1 L 45mm ø 17mm apto para Minisit			
	código	101136	referencia —
encendedor piezoeléctrico apto para Minisit con tapa ømm empalme F6,3x0,8			
	código	101137	referencia —
tapa sin piezoencendedor			
	código	101267	referencia —
reducción H 3/8" M 1/2" L 21mm			
	código	101268	referencia —
empalme de gas rosca 3/8" acodado con junta tórica MINISIT 710			
	código	101270	referencia —
unión roscada H 3/8" M 3/8" L 28mm			
	código	101272	referencia —
unión roscada H 1/2" M 3/8" L 57mm			
	código	101273	referencia —
anillo cortante para tubo ø 12mm L 9.5mm latón UE 1 pzs apto para universal			
	código	101274	referencia —
anillo cortante para tubo ø 16mm UE 1 pzs			
	código	101275	referencia —
tornillo de racor rosca 1/2" para tubo ø 16mm UE 1 pzs			
	código	101276	referencia 36Q0710
tornillo de racor rosca 3/8" tubo ø 12mm UE 1 pzs			

			
código	101131	referencia	33A0300
descripción	termostato de gas sin tapa, botón ni codo SIT tipo MINISIT 710 T máx 190°C 50-190°C entrada gas 1/2" salida gas 3/8" conexión termopar M9x1 conexión de piloto M10x1 sonda ø 5mm sonda L 98mm capilar 1200mm tipo de sensor tipo A2 regulador de presión no regulador de presiónmbar prensaestopas		
Para modelos:	B1101S, BF101L, BF101S, IS102S, IS102SR, IS102SR-0NR01, IS102SW, SM2L, SM2LW, SM2S, SM2SW, SM4SR, VS101L, XA72S, XS101L, XS101S, XS72S		
repuestos para	101131		
	código	101053	referencia 32Z1490
grupo magnético G1: M9x1 G2: M24x1 L 45mm ø 17mm apto para Minisit			
	código	102103	referencia —
sensor 60-200°C sonda ø 5mm sonda L 98mm capilar 1050mm T máx 200°C freidora tipo de sensor tipo A2 apto para MINISIT 710			

accesorios para		101131	
	código	100809	referencia —
junta tórica EPDM espesor 2mm int.ø 21mm UE 1 pzs			
	código	100820	referencia —
conducción para prensaestopas M M14x1,5 H M10x0,75 sonda ø máx. 6.5mm EC 22			
	código	100904	referencia —
tornillo de apriete M10x1 para tubo ø 4mm UE 1 pzs			
	código	100905	referencia —
tornillo de apriete M10x1 para tubo ø 6mm UE 1 pzs			
	código	101054	referencia —
grupo magnético G1: M10x1 G2: M24x1 L 45mm ø 17mm apto para Minisit			
	código	101136	referencia —
encendedor piezoeléctrico apto para Minisit con tapa ømm empalme F6,3x0,8			
	código	101137	referencia —
tapa sin piezoencendedor			
	código	101267	referencia —
reducción H 3/8" M 1/2" L 21mm			
	código	101268	referencia —
empalme de gas rosca 3/8" acodado con junta tórica MINISIT 710			
	código	101269	referencia —
empalme de gas rosca 1/2" acodado con junta tórica MINISIT 710			
	código	101270	referencia —
unión roscada H 3/8" M 3/8" L 28mm			
	código	101272	referencia —
unión roscada H 1/2" M 3/8" L 57mm			
	código	101273	referencia —
anillo cortante para tubo ø 12mm L 9.5mm latón UE 1 pzs apto para universal			
	código	101274	referencia —
anillo cortante para tubo ø 16mm UE 1 pzs			
	código	101275	referencia —
tornillo de racor rosca 1/2" para tubo ø 16mm UE 1 pzs			
	código	101276	referencia 36Q0710
tornillo de racor rosca 3/8" tubo ø 12mm UE 1 pzs			
	código	110068	referencia 36M0950
pomo apto para Minisit ø 37mm			



código	106241	referencia	6000380
descripción	termostato de gas SIT tipo MINISIT 710 T máx 190°C 50-190°C regulador de presión presente		
repuestos para	106241		
	código	101053	referencia 32Z1490
	grupo magnético G1: M9x1 G2: M24x1 L 45mm ø 17mm apto para Minisit		
accesorios para	106241		
	código	100809	referencia —
	junta tórica EPDM espesor 2mm int.ø 21mm UE 1 pzs		
	código	100904	referencia —
	tornillo de apriete M10x1 para tuboø 4mm UE 1 pzs		
	código	100905	referencia —
	tornillo de apriete M10x1 para tuboø 6mm UE 1 pzs		
	código	101054	referencia —
	grupo magnético G1: M10x1 G2: M24x1 L 45mm ø 17mm apto para Minisit		
	código	101136	referencia —
	encendedor piezoeléctrico apto para Minisit con tapa ømm empalme F6,3x0,8		
	código	101137	referencia —
	tapa sin piezoencendedor		
	código	101267	referencia —
	reducción H 3/8" M 1/2" L 21mm		
	código	101268	referencia —
	empalme de gas rosca 3/8" acodado con junta tórica MINISIT 710		
	código	101269	referencia —
	empalme de gas rosca 1/2" acodado con junta tórica MINISIT 710		
	código	101270	referencia —
	unión roscada H 3/8" M 3/8" L 28mm		
	código	101272	referencia —
	unión roscada H 1/2" M 3/8" L 57mm		
	código	101273	referencia —
	anillo cortante para tuboø 12mm L 9.5mm latón UE 1 pzs apto para universal		
	código	101274	referencia —
	anillo cortante para tuboø 16mm UE 1 pzs		
	código	101275	referencia —
	tornillo de racor rosca 1/2" para tuboø 16mm UE 1 pzs		

accesorios para	106241		
	código	101276	referencia 36Q0710
	tornillo de racor rosca 3/8" tubo ø 12mm UE 1 pzs		
	código	110068	referencia 36M0950
	pomo apto para Minisit ø 37mm		

código	106239	referencia	33A1031
descripción	termostato de gas SIT tipo MINISIT 710 T máx 340°C 100-340°C entrada gas 1/2" salida gas 3/8" conexión termopar M9x1 conexión de piloto M10x1 sonda ø 4mm sonda L 72mm capilar 1050mm tipo de sensor tipo C1 regulador de presión presente regulador de presión 3-18mbar prensaestopas		
Para modelos:	031FT04, 031FT06, 070FT04, 070FT05, 071FT04, 071FT06, 090FT04, 090FT05, 091FT04, 091FT06, 1G1BR1G, 31R, 712D, 712VA, 71D, 71DGG, 71TP, 72D, 72DGG, 72TP, 72TPGG, 72VA, 72VAGG, 72VAS, 72VASGG, 73D, 73DGG, 73VA, 73VAD, 73VADGG, 73VAGG, FS30		
repuestos para	106239		
	código	101053	referencia 32Z1490
	grupo magnético G1: M9x1 G2: M24x1 L 45mm ø 17mm apto para Minisit		
	código	102107	referencia —
	sensor 100-340°C sonda ø 4mm sonda L 72mm capilar 1050mm T máx 340°C horno/grill tipo de sensor tipo C1 apto para MINISIT 710		
accesorios para	106239		
	código	100809	referencia —
	junta tórica EPDM espesor 2mm int.ø 21mm UE 1 pzs		
	código	100904	referencia —
	tornillo de apriete M10x1 para tuboø 4mm UE 1 pzs		
	código	100905	referencia —
	tornillo de apriete M10x1 para tuboø 6mm UE 1 pzs		
	código	101137	referencia —
	tapa sin piezoencendedor		
	código	101267	referencia —
	reducción H 3/8" M 1/2" L 21mm		
	código	101268	referencia —
	empalme de gas rosca 3/8" acodado con junta tórica MINISIT 710		
	código	101269	referencia —
	empalme de gas rosca 1/2" acodado con junta tórica MINISIT 710		
	código	101270	referencia —
	unión roscada H 3/8" M 3/8" L 28mm		

Continúa en la página siguiente



accesorios para	106239			
	código	101272	referencia	—
		unión roscada H 1/2" M 3/8" L 57mm		
	código	101273	referencia	—
		anillo cortante para tuboø 12mm L 9.5mm latón UE 1 pzs apto para universal		
	código	101274	referencia	—
		anillo cortante para tuboø 16mm UE 1 pzs		
	código	101275	referencia	—
		tornillo de racor rosca 1/2" para tuboø 16mm UE 1 pzs		
	código	101276	referencia	36Q0710
		tornillo de racor rosca 3/8" tubo ø 12mm UE 1 pzs		
	código	110068	referencia	36M0950
		pomo apto para Minisit ø 37mm		

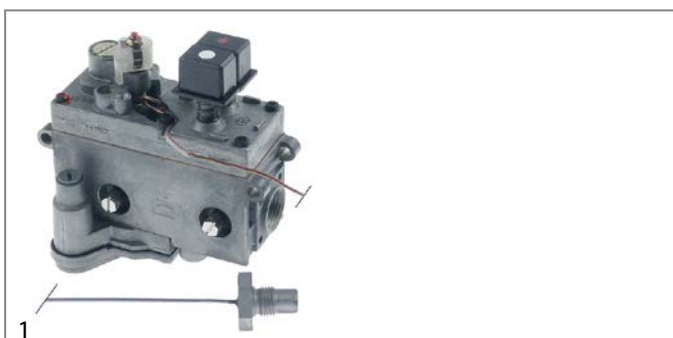

código	106240	referencia	33A1910 6000370	
descripción	termostato de gas SIT tipo MINISIT 710 T máx 340°C 100-340°C regulador de presión presente			
Para modelos:	0M0FT1G, 0M0FT2G, 0M0FT4G, 0M0FT5G, 1M0FT1G, 1M0FT2G, 1M0FT3G, 1M0FT4G, 1M0FT5G, 1M0FT6G, 2M0FT1G, 2M0FT2G, 2M0FT3G, 2M0FT4G, 2M0FT5G, 2M0FT6G			
repuestos para	106240			
	código	100068	referencia	—
		piloto de encendido 2 llamas empalme de gas 6mm		
	código	100809	referencia	—
		junta tórica EPDM espesor 2mm int.ø 21mm UE 1 pzs		
	código	100905	referencia	—
		tornillo de apriete M10x1 para tuboø 6mm UE 1 pzs		
	código	101137	referencia	—
		tapa sin piezoencendedor		
	código	101273	referencia	—
		anillo cortante para tuboø 12mm L 9.5mm latón UE 1 pzs apto para universal		
	código	101276	referencia	36Q0710
		tornillo de racor rosca 3/8" tubo ø 12mm UE 1 pzs		
	código	101505	referencia	—
		empalme de gas rosca 3/8" acodado sin junta tórica MINISIT 710		
	código	101516	referencia	—
		tornillo de cabeza plana rosca M4 rosca L 16mm inox DIN 7985/ISO 7045 UE 1 pzs		

repuestos para	106240			
	código	110068	referencia	36M0950
		pomo apto para Minisit ø 37mm		
accesorios para	106240			
	código	100904	referencia	—
		tornillo de apriete M10x1 para tuboø 4mm UE 1 pzs		
	código	101267	referencia	—
		reducción H 3/8" M 1/2" L 21mm		
	código	101268	referencia	—
		empalme de gas rosca 3/8" acodado con junta tórica MINISIT 710		
	código	101269	referencia	—
		empalme de gas rosca 1/2" acodado con junta tórica MINISIT 710		
	código	101270	referencia	—
		unión roscada H 3/8" M 3/8" L 28mm		
	código	101272	referencia	—
		unión roscada H 1/2" M 3/8" L 57mm		
	código	101273	referencia	—
		anillo cortante para tuboø 12mm L 9.5mm latón UE 1 pzs apto para universal		
	código	101274	referencia	—
		anillo cortante para tuboø 16mm UE 1 pzs		
	código	101275	referencia	—
		tornillo de racor rosca 1/2" para tuboø 16mm UE 1 pzs		
	código	101276	referencia	36Q0710
		tornillo de racor rosca 3/8" tubo ø 12mm UE 1 pzs		



código	101910 ¹	referencia	33A1130	
descripción	termostato de gas SIT tipo MINISIT 710 T máx 90°C 20-90°C entrada gas 1/2" salida gas 3/8" conexión termopar M9x1 conexión de piloto M10x1 sonda ø 10.5mm sonda L 19mm capilar 1050mm tipo de sensor tipo F2 regulador de presión presente regulador de presión 3-18mbar prensaestopas rosca sonda 1/4"			
Para modelos:	070BM, 071BM, 090BM, 091BM			
repuestos para	101910			
	código	101053	referencia	32Z1490
		grupo magnético G1: M9x1 G2: M24x1 L 45mm ø 17mm apto para Minisit		
	código	106223	referencia	—
		sensor 20-90°C sonda ø 11mm rosca sonda 1/4" sonda L 19mm capilar 1050mm T máx 90°C baño maría tipo de sensor tipo F2		

¹rosca de sonda 1/4"
Continúa en la página siguiente



accesorios para		101910		
	código	100809	referencia	—
	junta tórica EPDM espesor 2mm int.ø 21mm UE 1 pzs			
	código	100904	referencia	—
	tornillo de apriete M10x1 para tuboø 4mm UE 1 pzs			
	código	100905	referencia	—
	tornillo de apriete M10x1 para tuboø 6mm UE 1 pzs			
	código	101054	referencia	—
	grupo magnético G1: M10x1 G2: M24x1 L 45mm ø 17mm apto para Minisit			
	código	101136	referencia	—
	encendedor piezoeléctrico apto para Minisit con tapa ømm empalme F6,3x0,8			
	código	101137	referencia	—
	tapa sin piezoencendedor			
	código	101267	referencia	—
	reducción H 3/8" M 1/2" L 21mm			
	código	101268	referencia	—
	empalme de gas rosca 3/8" acodado con junta tórica MINISIT 710			
	código	101269	referencia	—
	empalme de gas rosca 1/2" acodado con junta tórica MINISIT 710			
	código	101270	referencia	—
	unión roscada H 3/8" M 3/8" L 28mm			
	código	101272	referencia	—
	unión roscada H 1/2" M 3/8" L 57mm			
	código	101273	referencia	—
	anillo cortante para tuboø 12mm L 9.5mm latón UE 1 pzs apto para universal			
	código	101274	referencia	—
	anillo cortante para tuboø 16mm UE 1 pzs			
	código	101275	referencia	—
	tornillo de racor rosca 1/2" para tuboø 16mm UE 1 pzs			
	código	101276	referencia	36Q0710
	tornillo de racor rosca 3/8" tubo ø 12mm UE 1 pzs			
	código	110068	referencia	36M0950
	pomo apto para Minisit ø 37mm			

PEL

serie 24ST



1

código		referencia		33A1850
descripción	termostato de gas PEL tipo 24ST 120-280°C entrada gas brida de tubo ø21mm boquilla bypass ø 0.35mm salida gas M20x1,5 (tubo ø 12/10mm) conexión termopar M9x1 conexión de piloto M10x1 capilar 1200mm sonda ø 6mm sonda L 120mm eje ø 10x8mm eje L 31/15mm parte plana arriba			
Para modelos:	0A0FT4G, 0A0FT5G, 0B0FT1G, 0B0FT2G, 0B0FT4G, 0B0FT5G, 0D0FT4G, 0D0FT5G, 0G0FT4G, 0G0FT5G, 1A0FT4G, 1A0FT6G, 1B0FT4G, 1B0FT6G, 1D0FT4G, 1D0FT6G, 1G0FT4G, 1G0FT6G			
repuestos para	106197			
	código	100455	referencia	—
	boquilla bypass tipo PEL23/24 taladro ø 0.35mm rosca M8x0,5			
	código	101058	referencia	32Z1460
	grupo magnético L 39mm D1 ø 15.4mm D2 ø 13.5mm apto para PEL22/EGA24197 estándar			
	código	106165	referencia	—
	junta ø 27mm			
	código	106200	referencia	—
	tuerca rosca M9x1 apto para PEL24/25S			
accesorios para	106197			
	código	100908	referencia	36Q1000
	tornillo de racor rosca M10x1 para tuboø 4mm UE 1 pzs			
	código	100909	referencia	36Q0060
	tornillo de racor rosca M10x1 para tuboø 6mm UE 1 pzs			
	código	101246	referencia	—
	anillo cortante para tuboø 4mm UE 1 pzs			
	código	101248	referencia	36Q0030
	anillo cortante para tuboø 12mm UE 1 pzs apto para PEL			
	código	101249	referencia	36Q1700
	anillo cortante para tuboø 10mm UE 1 pzs			
	código	101250	referencia	36Q0610
	tuerca de racor rosca M20x1.5 para ø de tubo 10mm			
	código	101251	referencia	36Q0050
	tuerca de racor rosca M20x1.5 para ø de tubo 12mm			
	código	101286	referencia	36Q0020
	anillo cortante int.ø 6mm UE 1 pzs			

Continúa en la página siguiente

accesorios para	106197			
	código	101331	referencia	—
	adaptador apto para PEL22 para tubo abocardado 10/12mm			



código	106198	referencia	33A1790
descripción	termostato de gas PEL tipo 24ST 140-340°C entrada gas brida de tubo ø21mm boquilla bypass ø0mm salida gas M20x1,5 (tubo ø 12/10mm) conexión termopar M8x1 conexión de piloto M10x1 capilar 1200mm sonda ø 6mm sonda L 100mm eje ø 10x9mm eje L 27/17mm parte plana arriba		
Para modelos:	0A0FT1G, 0A0FT2G, 0D0FT1G, 0D0FT2G, 0G0FT1G, 0G0FT2G, 1A0FT1G, 1A0FT2G, 1A0FT3G, 1B0FT1G, 1B0FT2G, 1B0FT3G, 1D0FT1G, 1D0FT2G, 1D0FT3G, 1G0FT1G, 1G0FT2G, 1G0FT3G		

repuestos para	106198			
	código	100455	referencia	—
	boquilla bypass tipo PEL23/24 taladro ø 0.35mm rosca M8x0,5			
	código	101058	referencia	32Z1460
	grupo magnético L 39mm D1 ø 15.4mm D2 ø 13.5mm apto para PEL22/EGA24197 estándar			
	código	101536	referencia	—
	junta D1 ø 17mm D2 ø 11.5mm espesor 4.7mm			
	código	106199	referencia	—
	tuerca rosca M8x1			
accesorios para	106198			
	código	100908	referencia	36Q1000
	tornillo de racor rosca M10x1 para tuboø 4mm UE 1 pzs			
	código	100909	referencia	36Q0060
	tornillo de racor rosca M10x1 para tuboø 6mm UE 1 pzs			
	código	101246	referencia	—
	anillo cortante para tuboø 4mm UE 1 pzs			
	código	101248	referencia	36Q0030
	anillo cortante para tuboø 12mm UE 1 pzs apto para PEL			
	código	101249	referencia	36Q1700
	anillo cortante para tuboø 10mm UE 1 pzs			
	código	101250	referencia	36Q0610
	tuerca de racor rosca M20x1.5 para ø de tubo 10mm			
	código	101251	referencia	36Q0050
	tuerca de racor rosca M20x1.5 para ø de tubo 12mm			
	código	101286	referencia	36Q0020
	anillo cortante int.ø 6mm UE 1 pzs			
	código	101331	referencia	—
	adaptador apto para PEL22 para tubo abocardado 10/12mm			

1				
código	101900	referencia	33A2840	
descripción	termostato de gas PEL tipo 24ST hasta 280°C entrada gas M20x1,5 (tubo ø 12mm) boquilla bypass ø 0.8mm salida gas M20x1,5 (tubo ø 12/10mm) conexión termopar M8x1 conexión de piloto M10x1 capilar 1200mm sonda ø 6mm sonda L 120mm eje ø 10x9mm eje L 31/15mm parte plana arriba			
Para modelos:	030FT, 030FTR, 031FT, 031FTR, 031FTRL, 31, 31TC, 31TP, 32, 32TC, 32TP, 32TPV, 32V			
repuestos para	101900			
	código	100497	referencia	33T4060
	boquilla bypass tipo PEL23/24 taladro ø 0.8mm rosca M8x0,5			
	código	101058	referencia	32Z1460
	grupo magnético L 39mm D1 ø 15.4mm D2 ø 13.5mm apto para PEL22/EGA24197 estándar			
	código	106199	referencia	—
	tuerca rosca M8x1			
accesorios para	101900			
	código	100908	referencia	36Q1000
	tornillo de racor rosca M10x1 para tuboø 4mm UE 1 pzs			
	código	100909	referencia	36Q0060
	tornillo de racor rosca M10x1 para tuboø 6mm UE 1 pzs			
	código	101246	referencia	—
	anillo cortante para tuboø 4mm UE 1 pzs			
	código	101248	referencia	36Q0030
	anillo cortante para tuboø 12mm UE 1 pzs apto para PEL			
	código	101249	referencia	36Q1700
	anillo cortante para tuboø 10mm UE 1 pzs			
	código	101250	referencia	36Q0610
	tuerca de racor rosca M20x1.5 para ø de tubo 10mm			
	código	101251	referencia	36Q0050
	tuerca de racor rosca M20x1.5 para ø de tubo 12mm			
	código	101286	referencia	36Q0020
	anillo cortante int.ø 6mm UE 1 pzs			
	código	110079	referencia	—
	símbolo para pomo termostato de gas 1-8 plata			
	código	110080	referencia	3FL1230
	pomo ø 70mm eje ø 10x8mm parte plana universal			



serie 24STS



código	101161	referencia	33A0060 6003911
descripción	termostato de gas PEL tipo 24STS 120-320°C entrada gas M20x1,5 (tubo ø 12/10mm) boquilla bypass ø 0.35mm salida gas M20x1,5 (tubo ø 12/10mm) conexión termopar M9x1 conexión de piloto M10x1 capilar 1200mm sonda ø 6mm sonda L 100mm eje ø 10x8mm eje L 27/17mm parte plana arriba		
repuestos para	101161		
	código	101058	referencia 32Z1460
	grupo magnético L 39mm D1 ø 15.4mm D2 ø 13.5mm apto para PEL22/EGA24197 estándar		
accesorios para	101161		
	código	101235	referencia —
	empalme de gas rosca M20x1.5 tubo ø 12/10mm para grifos de gas PEL horizontal		
	código	101236	referencia —
	empalme de gas rosca M20x1.5 tubo ø 12/10mm para grifos de gas PEL vertical		
	código	101240	referencia —
	empalme de gas rosca M20x1.5 tubo ø 12/10mm para grifos de gas PEL con junta y tronillos horizontal		
	código	101241	referencia —
	empalme de gas rosca M20x1.5 tubo ø 12/10mm para grifos de gas PEL vertical		
	código	101248	referencia 36Q0030
	anillo cortante para tubo ø 12mm UE 1 pzs apto para PEL		
	código	101249	referencia 36Q1700
	anillo cortante para tubo ø 10mm UE 1 pzs		
	código	101250	referencia 36Q0610
	tuerca de racor rosca M20x1.5 para ø de tubo 10mm		
	código	101251	referencia 36Q0050
	tuerca de racor rosca M20x1.5 para ø de tubo 12mm		
	código	101365	referencia —
	empalme de gas rosca M20x1.5 tubo ø 12mm para grifos de gas PEL horizontal		
	código	101460	referencia —
	junta tórica ø 12.37mm D1 ø 2.62mm apto para PEL22		
	código	101461	referencia —
	tornillo Kit apto para PEL22 UE 4 pzs		
	código	110079	referencia —
	símbolo para pomo termostato de gas 1-8 plata		
	código	110080	referencia 3FL1230
	pomo ø 70mm eje ø 10x8mm parte plana universal		

serie 25ST





código	101565	referencia	33A0660
descripción	termostato de gas PEL tipo 25ST hasta 280°C entrada gas brida de tubo ø21mm boquilla bypass ø 0mm salida gas M16x1,5 (tubo ø 10/8mm) conexión termopar M9x1 conexión de piloto M10x1 capilar 1200mm sonda ø 6mm sonda L 122mm eje ø 8x6,5mm eje L 21/15mm parte plana arriba entrada de tubo ø 9mm		
Para modelos:	1G1FA0G, 1G1FA0GV, 1G1FABG, 1G1FAPG, 1G1TP0G, 2G1FA0G, 2G1FA0GV, 2G1FABG, 2G1FACG, 2G1FADG, 2G1FADGV, 2G1FAPG, 2G1TP3G, G1FAGS, G1FAGST		

válvulas de gas y centralitas de gas automáticas

válvulas de control de gas

HONEYWELL



código	106004	referencia	32V5810
descripción	válvula de gas tipo VK4105C 220-240V 50/60Hz entrada gas brida 32x32mm salida gas brida 32x32mm conexión termopar conexión de piloto margen de presión 15-60mbar máx. 60mbar tipo de operador tipo de regulación V5306E 1234 1 apto para HONEYWELL brida 32x32mm		
Para modelos:	FCV61DS-CSA		
accesorios para	106004		
	código	102845	referencia —
	empalme de gas acodado 1/2" brida 32x32mm dist. del agujero 24x24mm Tandem		
	código	102846	referencia —
	empalme de gas recto 1/2" brida 32x32mm dist. del agujero 24x24mm apto para Tandem		

SIT

ELETTROSIT



código	101993	referencia	33A0590
descripción	válvula de gas SIT tipo ELETTROSIT aliment. 230V entrada gas 1/2" salida gas 1/2" conexión termopar M9x1 conexión de piloto M10x1 lateral núm. Ref. 0.810.126		
Para modelos:	30F1, 30F1B, 30FS2, 30FS2B, 70F1, 70F1B, 71AR, 71F2, 71F2B, 71RA, 90F110B, 91AR, 91F210, 91F210B, 91F223B, 91RA, FC101, FC61, FCV101, FCV101DM, FCV101DS, FCV241GDM, FCV241GDS, FCV401DM, FCV61, FCV61DM, FCV61DS		
repuestos para	101993		
	código	101312	referencia 33A0020
			microinterruptor
	código	101352	referencia —
			bobina magnética aliment. 230V 50Hz apto para ELETTROSIT
accesorios para	101993		
	código	100006	referencia —
			encendedor piezoeléctrico apto para ELETTROSIT cuerpo plástico soplado empalme ø2,4mm ø 14mm
	código	100904	referencia —
			tornillo de apriete M10x1 para tubo ø 4mm UE 1 pzs
	código	100905	referencia —
			tornillo de apriete M10x1 para tubo ø 6mm UE 1 pzs
	código	101301	referencia —
			empalme de gas rosca 1/2" recto ELETTROSIT atornillado con junta tórica
	código	101303	referencia —
			empalme de gas recto rosca 3/4" ELETTROSIT
	código	101309	referencia —
			extensión
	código	103104	referencia —
			interruptor de encendido
	código	541504	referencia 33Q5880
			boquilla doble rosca 1/2" - 1/2"





código	101127	referencia	33A0530
descripción	válvula de gas SIT tipo ELETTROSIT aliment. 230V entrada gas 3/4" salida gas 3/4" conexión termopar M9x1 conexión de piloto M10x1 lateral núm. Ref. 0.810.175		
Para modelos:	FC241, FC241G, FCV141, FCV141DM, FCV141DS, FCV241, FCV241DM, FCV241DS, FCV241G		
repuestos para	101127		
	código	101312	referencia 33A0020
			microinterruptor
	código	101352	referencia —
			bobina magnética aliment. 230V 50Hz apto para ELETTROSIT
accesorios para	101127		
	código	100006	referencia —
			encendedor piezoeléctrico apto para ELETTROSIT cuerpo plástico soplado empalme ø2,4mm ø 14mm
	código	100904	referencia —
			tornillo de apriete M10x1 para tubo ø 4mm UE 1 pzs
	código	100905	referencia —
			tornillo de apriete M10x1 para tubo ø 6mm UE 1 pzs
	código	101301	referencia —
			empalme de gas rosca 1/2" recto ELETTROSIT atornillado con junta tórica
	código	101303	referencia —
			empalme de gas recto rosca 3/4" ELETTROSIT
	código	101309	referencia —
			extensión



NOVASIT





código	101760	referencia	33A1640
descripción	válvula de gas SIT serie Novasit 820 aliment. 220V 50Hz entrada gas 1/2" salida gas 1/2" conexión termopar M9x1 conexión de piloto M10x1 presión de encendido 3-5mbar margen de presión 3-30mbar conexión del presostato ciego núm. Ref. 0.820.060		
Para modelos:	091FR1G, 091FR3G, 191FR2GD, 191FR4GD		
repuestos para	101760		
	código	101065	referencia —
		grupo magnético con cable L 44mm D1 ø 30mm D2 ø 20mm apto para NOVASIT	
	código	101867	referencia —
		bobina magnética 220V 60Hz	
accesorios para	101760		
	código	100006	referencia —
		encendedor piezoeléctrico apto para ELETTROSIT cuerpo plástico soplado empalme ø2,4mm ø 14mm	
	código	100904	referencia —
		tornillo de apriete M10x1 para tubo ø 4mm UE 1 pzs	
	código	100905	referencia —
		tornillo de apriete M10x1 para tubo ø 6mm UE 1 pzs	
	código	101305	referencia —
		empalme de gas recto 1/2" brida 45x45mm ELETTROSIT/V4400/4600/4605 para SIT/HONEYWELL dist. del agujero 36x36mm	
	código	101306	referencia —
		empalme de gas acodado brida 45x45mm dist. del agujero 36x36mm 1/2" ELETTROSIT/V4400/4600/4605 atornillado con junta tórica para SIT/HONEYWELL	
	código	101307	referencia —
		empalme de gas recto brida 45x45mm dist. del agujero 36x36mm 3/4" ELETTROSIT/V4400/4600/4605 atornillado con junta tórica para SIT/HONEYWELL	
	código	101308	referencia —
		empalme de gas acodado brida 45x45mm dist. del agujero 36x36mm 3/4" ELETTROSIT/V4400/4600/4605 atornillado con junta tórica para SIT/HONEYWELL	
	código	101312	referencia 33A0020
		microinterruptor	
	código	101313	referencia —
		bobina magnética 230V 50Hz	
	código	101314	referencia —
		bobina magnética 24V 50Hz	
	código	101317	referencia —
		conector con cable L 1000mm apto para NOVASIT	

accesorios para	101760		
	código	101318	referencia —
		tapa para solenoide apto para NOVASIT	
	código	101503	referencia —
		junta tórica EPDM espesor 2mm int.ø 32mm UE 1 pzs	



código	101162	referencia	33A0460
descripción	válvula de gas SIT serie Novasit 820 aliment. 230V 50Hz entrada gas 1/2" salida gas 1/2" conexión termopar M9x1 conexión de piloto M10x1 presión de encendido 3-5mbar margen de presión 3-30mbar conexión del presostato ciego núm. Ref. 0.820.010		
Para modelos:	06WFR3GD, 091FR1G, 091FR1GD, 091FR3G, 091FR3GD, 0A1FR1G, 0A1FR1GD, 0A1FR1GD-VERS.2004, 0A1FR1G-VERS.2004, 0A1FR3G, 0A1FR3GD, 0B1FR1G, 0B1FR1GD, 0D1FR1G, 0D1FR1GD, 0D1FR1GD-VERS.2004, 0D1FR1G-VERS.2004, 0D1FR3G, 0D1FR3GD, 0G1FR3G, 0G1FR3GD, 10WFR4GD, 191FR2G, 191FR2GD, 191FR4G, 191FR4GD, 1A1FR2G, 1A1FR2GD, 1A1FR2GD-VERS.2004, 1A1FR2G-VERS.2004, 1A1FR4G, 1A1FR4GD, 1D1FR2G, 1D1FR2GD, 1D1FR2GD-VERS.2004, 1D1FR2G-VERS.2004, 1D1FR4G, 1D1FR4GD, 1G1FR4G, 1G1FR4GD, FC101, FC241G, FC61, FCV101, FCV101DM, FCV101DS, FCV141, FCV141DM, FCV141DS, FCV241G... (Otros modelos se puede ver en la tienda web)		
repuestos para	101162		
	código	101065	referencia —
		grupo magnético con cable L 44mm D1 ø 30mm D2 ø 20mm apto para NOVASIT	
	código	101313	referencia —
		bobina magnética 230V 50Hz	
accesorios para	101162		
	código	100006	referencia —
		encendedor piezoeléctrico apto para ELETTROSIT cuerpo plástico soplado empalme ø2,4mm ø 14mm	
	código	101305	referencia —
		empalme de gas recto 1/2" brida 45x45mm ELETTROSIT/V4400/4600/4605 para SIT/HONEYWELL dist. del agujero 36x36mm	
	código	101306	referencia —
		empalme de gas acodado brida 45x45mm dist. del agujero 36x36mm 1/2" ELETTROSIT/V4400/4600/4605 atornillado con junta tórica para SIT/HONEYWELL	
	código	101307	referencia —
		empalme de gas recto brida 45x45mm dist. del agujero 36x36mm 3/4" ELETTROSIT/V4400/4600/4605 atornillado con junta tórica para SIT/HONEYWELL	
	código	101308	referencia —
		empalme de gas acodado brida 45x45mm dist. del agujero 36x36mm 3/4" ELETTROSIT/V4400/4600/4605 atornillado con junta tórica para SIT/HONEYWELL	
	código	101312	referencia 33A0020
		microinterruptor	
	código	101314	referencia —
		bobina magnética 24V 50Hz	





Continúa en la página siguiente

accesorios para	101162			
	código	101317	referencia	—
	conector con cable L 1000mm apto para NOVASIT			
	código	101318	referencia	—
	tapa para solenoide apto para NOVASIT			



1

código	101688	referencia	33A0930
descripción	válvula de gas SIT serie Novasit 824 aliment. 230V 50Hz entrada gas 1/2" salida gas 1/2" conexión termopar M9x1 conexión de piloto M10x1 presión de encendidombar margen de presión 2-50mbar conexión del presostato núm. Ref. 0.824.011		
Para modelos:	191BR1G, 191BR1GA, 191BR2G, 191BR2GA, 1A1BR1G, 1A1BR1GA, 1A1BR2G, 1A1BR2GA, 1D1BR1G, 1D1BR1GA, 1D1BR2G, 1D1BR2GA, 291BR1G, 291BR1GA, 291BR2G, 291BR2GA, 2A1BR1G, 2A1BR1GA, 2A1BR2G, 2A1BR2GA, 2D1BR1G, 2D1BR1GA, 2D1BR2G, 2D1BR2GA		
repuestos para	101688		
	código	101065	referencia —
	grupo magnético con cable L 44mm D1 ø 30mm D2 ø 20mm apto para NOVASIT		
	código	101313	referencia —
	bobina magnética 230V 50Hz		
accesorios para	101688		
	código	100006	referencia —
	encendedor piezoeléctrico apto para ELETROSIT cuerpo plástico soplado empalme ø2,4mm ø 14mm		
	código	100904	referencia —
	tornillo de apriete M10x1 para tubo ø 4mm UE 1 pzs		
	código	100905	referencia —
	tornillo de apriete M10x1 para tubo ø 6mm UE 1 pzs		
	código	101305	referencia —
	empalme de gas recto 1/2" brida 45x45mm ELETROSIT/V4400/4600/4605 para SIT/HONEYWELL dist. del agujero 36x36mm		
	código	101306	referencia —
	empalme de gas acodado brida 45x45mm dist. del agujero 36x36mm 1/2" ELETROSIT/V4400/4600/4605 atornillado con junta tórica para SIT/HONEYWELL		
	código	101307	referencia —
	empalme de gas recto brida 45x45mm dist. del agujero 36x36mm 3/4" ELETROSIT/V4400/4600/4605 atornillado con junta tórica para SIT/HONEYWELL		
	código	101308	referencia —
	empalme de gas acodado brida 45x45mm dist. del agujero 36x36mm 3/4" ELETROSIT/V4400/4600/4605 atornillado con junta tórica para SIT/HONEYWELL		
	código	101312	referencia 33A0020
	microinterruptor		

accesorios para	101688		
	código	101314	referencia —
	bobina magnética 24V 50Hz		
	código	101317	referencia —
	conector con cable L 1000mm apto para NOVASIT		
	código	101318	referencia —
	tapa para solenoide apto para NOVASIT		
	código	101503	referencia —
	junta tórica EPDM espesor 2mm int.ø 32mm UE 1 pzs		

SIGMA



1

código	107893	referencia	3041070
descripción	válvula de gas tipo 0840028 aliment. 220V 60Hz entrada gas 3/4" salida gas 3/4" margen de presión 2-50mbar		
Para modelos:	091FR1I, 091FR1IA, 091FR1ID, 091FR1ID-VERS.052012, 091FR1I-VERS.032012, 091FR7G, 091FR7GS, 091FR7G-VERS.052012, 091FR7GX, 191FR2I, 191FR2ID, 191FR2ID-VERS.092012, 191FR2I-VERS.032012, FC1011G, FC1221G, FC611G, FM1011G1, FM1011G1-VERS.2006, FM1011G2, FM1011G2-VERS.2006, FM1011G3, FM1011G3-VERS.2006, FM2011G2-VERS.2006, FM2011G3-VERS.2006, FM2021G1, FM2021G2, FM2021G2-VERS.2006, FM2021G3, FM2021G3-VERS.2006, FM611G1, FM611G1-VERS.2006, FM611G2, FM611G2-VERS.2006, FM611G3, FM611G3-VERS.2006, FM721G1, FM721G1-VERS.2006, FM721G2, FM721G2-VERS.2006, FM721G3, FM721G3-VERS.2006		





1

código	107894	referencia	6300749
descripción	válvula de gas tipo 0848083 aliment. 230V 50Hz entrada gas 3/4" salida gas 3/4" margen de presión 0,5-12mbar		
Para modelos:	BX101G, BX101G-VERS.122013, BX122G, BX122G-VERS.122013, BX61G, BX61G-VERS.122013, BX82G, BX82G-VERS.122013, FX101G1, FX101G1R, FX101G2, FX101G2C, FX101G2C-VERS.032014, FX101G2R, FX101G2R-VERS.032014, FX101G2-VERS.032014, FX101G3, FX101G3C, FX101G3C-VERS.022014, FX101G3R, FX101G3R-VERS.022014, FX101G3-VERS.022014, FX10G2CR, FX10G2CR-VERS.032014, FX10G3CR, FX10G3CR-VERS.022014, FX122G1, FX122G2, FX122G2C, FX122G2T, FX122G2T-VERS.032014, FX122G3, FX122G3C, FX122G3T, FX122G3T-VERS.022014, FX12G3CT, FX12G3CT-VERS.022014, FX201G2, FX201G2P, FX201G2P-VERS.032014, FX201G2-VERS.032014, FX201G3P, FX201G3-VERS.022014, FX202G2, FX202G2-VERS.032014, FX202G3, FX202G3-VERS.022014, FX61G1, FX61G1R, FX61G2...(Otros modelos se puede ver en la tienda web)		



1

código	107241	referencia	32V5800
descripción	válvula de gas tipo Sigma aliment. 230V 50Hz entrada gas 3/4" salida gas 3/4" margen de presión 2-50mbar		
Para modelos:	FC1011G, FC611G, FM1011G1, FM1011G1-VERS.2006, FM1011G2, FM1011G2-VERS.2006, FM1011G3, FM1011G3-VERS.2006, FM2011G2-VERS.2006, FM2011G3-VERS.2006, FM2021G1, FM2021G2, FM2021G2-VERS.2006, FM2021G3, FM2021G3-VERS.2006, FM611G1, FM611G1-VERS.2006, FM611G2, FM611G2-VERS.2006, FM611G3, FM611G3-VERS.2006, FM721G1, FM721G1-VERS.2006, FM721G2, FM721G2-VERS.2006, FM721G3, FM721G3-VERS.2006		
repuestos para	107241		
	código	106214	referencia 3188170
			bobina magnética aliment. 230V 50Hz Sigma
accesorios para	107241		
	código	107222	referencia —
			conector para válvula magnética 3 polos longitud del cable 1070mm



2

código	107547	referencia	3011580
descripción	válvula de gas tipo Sigma aliment. 230V 50Hz entrada gas 3/4" M salida gas 3/4" M margen de presión 2-50mbar núm. Ref. 0063AS4831		
Para modelos:	091FR1I, 091FR1IA, 091FR1ID, 091FR1ID-VERS.052012, 091FR1I-VERS.032012, 091FR7G, 091FR7GS, 091FR7G-VERS.052012, 091FR7GX, 191FR2I, 191FR2ID, 191FR2ID-VERS.092012, 191FR2I-VERS.032012, FC1221G, FM1221G1, FM1221G1-VERS.2006, FM1221G2, FM1221G2-VERS.2006, FM1221G3, FM1221G3-VERS.2006		
repuestos para	107547		
	código	106214	referencia 3188170
			bobina magnética aliment. 230V 50Hz Sigma
accesorios para	107547		
	código	107222	referencia —
			conector para válvula magnética 3 polos longitud del cable 1070mm

centralitas de gas automáticas

BRAHMA



1

código	107545	referencia	3128260
descripción	centralita de gas automática BRAHMA tipo ECM113 electrodos 3 tiempo de espera 1.5s tiempo de seguridad 3s 100-240V 15VA 50-60Hz		
Para modelos:	091FR1I, 091FR1IA, 091FR1ID, 091FR1ID-VERS.052012, 091FR1I-VERS.032012, 091FR7G, 091FR7GS, 091FR7G-VERS.052012, 091FR7GX, 10CP11A, 12CP11A, 18CP2IA, 191FR2I, 191FR2ID, 191FR2ID-VERS.092012, 191FR2I-VERS.032012		



otros



1

código	103221	referencia	32V5850 32V5851
descripción	centralita de gas automática RV CONSTRUCTIONS ELECTRIQUES tipo 0526 tiempo de espera 7s tiempo de seguridad 10s 230V 50/60Hz		
Para modelos:	FC1011G, FC1221G, FC611G, FM1011G1, FM1011G1-VERS.2006, FM1011G2, FM1011G2-VERS.2006, FM1011G3, FM1011G3-VERS.2006, FM1221G1, FM1221G1-VERS.2006, FM1221G2, FM1221G2-VERS.2006, FM1221G3, FM1221G3-VERS.2006, FM2011G2-VERS.2006, FM2011G3-VERS.2006, FM2021G1, FM2021G2, FM2021G2-VERS.2006, FM2021G3, FM2021G3-VERS.2006, FM611G1, FM611G1-VERS.2006, FM611G2, FM611G2-VERS.2006, FM611G3, FM611G3-VERS.2006, FM721G1, FM721G1-VERS.2006, FM721G2, FM721G2-VERS.2006, FM721G3, FM721G3-VERS.2006		



válvulas de seguridad

SIT

serie 440



1

código	101101	referencia	33A0430	
descripción	válvula de gas margen de presión 50mbar entrada gas 3/4" salida gas 3/4" conexión de piloto M10x1 (tubo ø 6mm) conexión tempopar M9x1 tipo SIT D3			
accesorios para	101101			
	código	100904	referencia	—
	tornillo de apriete M10x1 para tubo ø 4mm UE 1 pzs			
	código	100905	referencia	—
	tornillo de apriete M10x1 para tubo ø 6mm UE 1 pzs			

válvulas magnéticas de gas

BRAHMA

BRAHMA



1

código	101948 ¹	referencia	33A1650	
descripción	válvula magnética 230VAC DN 15mm empalme 1/2" L 72mm BRAHMA tipo de bobina 18811003 p máx. 0.5bar N° reg. CE 63AQ0626			
Para modelos:	1A1PI2G, 1A1PI2GA, 1D1PI2G, 1D1PI2GA, 291PI3G, 2A1PI3G, 2D1PI3G			
repuestos para	101948			
	código	101968	referencia	—
	válvula magnética 230VAC 20VA soporte ø 17mm tipo de bobina 13902001 BRAHMA			

¹carcasa de aluminio

encendidos y tempopares

pilotos de encendido

SIT

serie 100







1

código	106905	referencia	33A0410 6000290	
descripción	piloto de encendido SIT tipo serie 100 2 llamas boquilla ø 0.2mm empalme de gas 6mm			
repuestos para	106905			
	código	100245	referencia	—
	boquilla de quemador piloto gas licuado código 20 taladro ø 0.2mm UE 1 pzs rosca M8x0,75			
	código	100855	referencia	33S0950
	portapilotos triple			
	código	100885	referencia	33A0970
	casquillo de mezcla de aire para quemador piloto UE 1 pzs			
	código	100916	referencia	—
	resorte de compresión para quemador piloto UE 1 pzs			
	código	100917	referencia	—
	junta para quemador piloto UE 1 pzs aluminio			

Continúa en la página siguiente



repuestos para		106905	
	código	100918	referencia —
tornillo para quemador piloto			
	código	107161	referencia —
parte superior de quemador piloto SIT 2 llamas Hmm Lmm UE 1 pzs			
	código	107701	referencia —
parte inferior de quemador piloto SIT serie 100 boquilla ø 0.2mm			
accesorios para		106905	
	código	100246	referencia 33T0410
boquilla de quemador piloto gas natural taladro ø 0.35mm UE 1 pzs rosca M8x0,75			
	código	100904	referencia —
tornillo de apriete M10x1 para tubo ø 4mm UE 1 pzs			
	código	100905	referencia —
tornillo de apriete M10x1 para tubo ø 6mm UE 1 pzs			
	código	102110	referencia —
tubo piloto cobre diámetro ø 4mm grosor de la pared 1mm L 3000mm			
	código	102111	referencia —
tubo piloto cobre diámetro ø 6mm grosor de la pared 1mm L 3000mm			
	código	107171	referencia 33T0340
boquilla de quemador piloto SIT gas natural/licuado taladro ø 0.25mm UE 1 pzs			
	código	107700	referencia 33A0960
parte inferior de quemador piloto SIT serie 100 boquilla ø 0.25mm			
	código	107702	referencia 33A2900
parte inferior de quemador piloto SIT serie 100 boquilla ø 0.35mm			

 <p>1</p>			
código	106906	referencia	6000350
descripción	piloto de encendido SIT tipo serie 100 3 llamas boquilla ø 0.2mm empalme de gas 6mm		
Para modelos:	71AR, 91AR, FS30		
repuestos para		106906	
	código	100245	referencia —
boquilla de quemador piloto gas licuado código 20 taladro ø 0.2mm UE 1 pzs rosca M8x0,75			
	código	100855	referencia 33S0950
portapilotos triple			
	código	100885	referencia 33A0970
casquillo de mezcla de aire para quemador piloto UE 1 pzs			
	código	100916	referencia —
resorte de compresión para quemador piloto UE 1 pzs			

repuestos para		106906	
	código	100917	referencia —
junta para quemador piloto UE 1 pzs aluminio			
	código	100918	referencia —
tornillo para quemador piloto			
	código	107162	referencia 33A1080 33A1081
parte superior de quemador piloto SIT 3 llamas Hmm Lmm UE 1 pzs			
	código	107701	referencia —
parte inferior de quemador piloto SIT serie 100 boquilla ø 0.2mm			
accesorios para		106906	
	código	100245	referencia —
boquilla de quemador piloto gas licuado código 20 taladro ø 0.2mm UE 1 pzs rosca M8x0,75			
	código	100246	referencia 33T0410
boquilla de quemador piloto gas natural taladro ø 0.35mm UE 1 pzs rosca M8x0,75			
	código	100904	referencia —
tornillo de apriete M10x1 para tubo ø 4mm UE 1 pzs			
	código	100905	referencia —
tornillo de apriete M10x1 para tubo ø 6mm UE 1 pzs			
	código	102110	referencia —
tubo piloto cobre diámetro ø 4mm grosor de la pared 1mm L 3000mm			
	código	102111	referencia —
tubo piloto cobre diámetro ø 6mm grosor de la pared 1mm L 3000mm			
	código	107171	referencia 33T0340
boquilla de quemador piloto SIT gas natural/licuado taladro ø 0.25mm UE 1 pzs			
	código	107700	referencia 33A0960
parte inferior de quemador piloto SIT serie 100 boquilla ø 0.25mm			
	código	107702	referencia 33A2900
parte inferior de quemador piloto SIT serie 100 boquilla ø 0.35mm			

accesorios

parte superior de piloto de encendido



código	107166	referencia	33A0380
descripción	cabezal de quemador piloto SIT 1 llama Hmm Lmm UE 1 pzs		



1

código	100832	referencia	33A1070
descripción	parte superior de quemador piloto 1 llama apto para serie 100 Hmm Lmm UE 1 pzs		
Para modelos:	030, 031, 032, 070D, 070DGG, 0712D, 0712VA, 071D, 071DGG, 072D, 072DGG, 090, 090GG, 091, 091GG, 092, 092GG, 092VA, 092VAGG, 0A0FAS, 0B0FAS, 0D0FAS, 1A0FAS, 1A0FAS2, 1A1FAS2G, 1A1FASG, 1B0FAS, 1B0FAS2, 1B1FAS2G, 1B1FASG, 1D0FAS, 1D0FAS2, 1D1FAS2G, 1D1FASG, 2A0FAS2, 2A1FAS2G, 2A1FASG, 2A1TPSG, 2D0FAS2, 2D1FAS2G, 2D1FASG, 2D1TPSG, 31, 31GE, 31TC, 32, 32TC, 32TP, 32TPV, 32V...(Otros modelos se puede ver en la tienda web)		



1

código	100835	referencia	32Z2241
descripción	parte superior de quemador piloto 3 llamas apto para serie 100 H 35mm L 48mm UE 1 pzs An 52mm		
Para modelos:	090BM1G, 0A0BMG, 0A1FR1G, 0A1FR1GD, 0B1FR1G, 0B1FR1GD, 0D0BMG, 0D1FR1G, 0D1FR1GD, 190BM2G, 1A0BMG, 1A1FR2G, 1A1FR2GD, 1D0BMG, 1D1FR2G, 1D1FR2GD, 30CP, 30F, 30F1, 30F1B, 30F5, 30F52, 30F52B, 60SM, 70CP, 70F, 70F1, 70F1B, 71CP, 71CP2, 71F, 71F2, 71F2B, 90CP, 90F110B, 91CP, 91F210, 91F210B, 91F223B		



1

código	107162	referencia	33A1080 33A1081
descripción	parte superior de quemador piloto SIT 3 llamas Hmm Lmm UE 1 pzs		
Para modelos:	030FT, 030FTR, 031FT, 031FT04, 031FT06, 031FTR, 031FTRL, 031TP, 06WCP1GM, 06WFR3GD, 070BM, 070FT, 070FT04, 070FT05, 070FTR, 0712VA, 071BM, 071FT, 071FT04, 071FT06, 071FTR, 071FTRL, 071TP, 08WCP1GM, 08WFA4G, 08WFAAG, 08WFT1GV, 08WFT2GV, 08WFT3GV, 08WFT4GV, 08WFT6GV, 08WFT7GV, 090BM, 090FAVA, 090FT, 090FT04, 090FT05, 090FT1G, 090FT2G, 090FT4G, 090FT5G, 090FT7G, 090FTR, 091BM, 091CP1G, 091FR1G, 091FR1GD, 091FR3G, 091FR3GD, 091FT...(Otros modelos se puede ver en la tienda web)		

parte inferior de piloto de encendido



1

código	100998	referencia	33A0200
descripción	parte inferior de quemador piloto boquilla ø 0.21mm apto para serie 100		
Para modelos:	030, 031, 032, 31, 31GE, 31TC, 32, 32TC, 32TP, 32TPV, 32V		



1

código	107700	referencia	33A0960
descripción	parte inferior de quemador piloto SIT serie 100 boquilla ø 0.25mm		
Para modelos:	031FT04, 031FT06, 06WFR3GD, 070FT04, 070FT05, 071FT04, 071FT06, 08WCP1GM, 08WFT1GV, 08WFT2GV, 08WFT3GV, 08WFT4GV, 08WFT6GV, 08WFT7GV, 090FT04, 090FT05, 091FT04, 091FT06, 0A0FAVA, 0A1FR3G, 0A1FR3GD, 0D0FAVA, 0D1FR3G, 0D1FR3GD, 0G0FT1G, 0G0FT2G, 0G0FT4G, 0G0FT5G, 0G1CP1G, 0G1FR3G, 0G1FR3GD, 10WFR4GD, 1A1FR4G, 1A1FR4GD, 1D1FR4G, 1D1FR4GD, 1G0FT1G, 1G0FT2G, 1G0FT3G, 1G0FT4G, 1G0FT6G, 1G0TP0, 1G1BR1G, 1G1CP1G, 1G1CP2G, 1G1FA0G, 1G1FABG, 1G1FAPG, 1G1FR4G, 1G1FR4GD...(Otros modelos se puede ver en la tienda web)		

repuestos para	107700		
-----------------------	--------	--	--



código	100916	referencia	—
descripción	resorte de compresión para quemador piloto UE 1 pzs		



código	100917	referencia	—
descripción	junta para quemador piloto UE 1 pzs aluminio		



código	100918	referencia	—
descripción	tornillo para quemador piloto		



código	102742	referencia	—
descripción	boquilla de quemador piloto gas licuado código 25 taladro ø 0.25mm UE 1 pzs		

accesorios para	107700		
------------------------	--------	--	--



código	100245	referencia	—
descripción	boquilla de quemador piloto gas licuado código 20 taladro ø 0.2mm UE 1 pzs rosca M8x0,75		



código	100246	referencia	33T0410
descripción	boquilla de quemador piloto gas natural taladro ø 0.35mm UE 1 pzs rosca M8x0,75		



código	100904	referencia	—
descripción	tornillo de apriete M10x1 para tubo ø 4mm UE 1 pzs		



código	100905	referencia	—
descripción	tornillo de apriete M10x1 para tubo ø 6mm UE 1 pzs		



código	102110	referencia	—
descripción	tubo piloto cobre diámetro ø 4mm grosor de la pared 1mm L 3000mm		



código	102111	referencia	—
descripción	tubo piloto cobre diámetro ø 6mm grosor de la pared 1mm L 3000mm		





 <p>1</p>			
código	107702	referencia	33A2900
descripción	parte inferior de quemador piloto SIT serie 100 boquilla ø 0.35mm		
Para modelos:	030FT, 030FTR, 031FT, 031FTR, 031FTRL, 031TP, 070BM, 070D, 070DGG, 070FT, 070FTR, 0712D, 0712VA, 071BM, 071D, 071DGG, 071FT, 071FTR, 071FTRL, 071TP, 072D, 072DGG, 090, 090BM, 090FT, 090FTR, 090GG, 091, 091BM, 091FT, 091FTR, 091FTRL, 091GG, 091TP, 092, 092GG, 092VA, 092VAGG, 0A0BMG, 0A0FAS, 0A0FT1G, 0A0FT2G, 0A0FT4G, 0A0FT5G, 0A1FR1G, 0A1FR1GD, 0D0BMG, 0D0FAS, 0D0FT1G, 0D0FT2G...(Otros modelos se puede ver en la tienda web)		
repuestos para	107702		
	código	100246	referencia 33T0410
	boquilla de quemador piloto gas natural taladro ø 0.35mm UE 1 pzs rosca M8x0,75		
	código	100916	referencia —
	resorte de compresión para quemador piloto UE 1 pzs		
	código	100917	referencia —
	junta para quemador piloto UE 1 pzs aluminio		
	código	100918	referencia —
	tornillo para quemador piloto		
accesorios para	107702		
	código	100245	referencia —
	boquilla de quemador piloto gas licuado código 20 taladro ø 0.2mm UE 1 pzs rosca M8x0,75		
	código	100904	referencia —
	tornillo de apriete M10x1 para tubo ø 4mm UE 1 pzs		
	código	100905	referencia —
	tornillo de apriete M10x1 para tubo ø 6mm UE 1 pzs		
	código	102110	referencia —
	tubo piloto cobre diámetro ø 4mm grosor de la pared 1mm L 3000mm		
	código	102111	referencia —
	tubo piloto cobre diámetro ø 6mm grosor de la pared 1mm L 3000mm		
	código	102742	referencia —
	boquilla de quemador piloto gas licuado código 25 taladro ø 0.25mm UE 1 pzs		



 <p>1</p>			
código	100880	referencia	33A0690
descripción	parte inferior de quemador piloto SIT serie 100 boquilla ø 0.4mm		

portapilotos			
universal			
 <p>1</p>			
código	100887	referencia	33A0950
descripción	contrasoporte para quemador piloto apto para serie 100		
Para modelos:	030, 030FT, 030FTR, 031, 031FT, 031FT04, 031FT06, 031FTR, 031FTRL, 031TP, 032, 06WCP1GM, 06WFR3GD, 070BM, 070D, 070DGG, 070FT, 070FT04, 070FT05, 070FTR, 0712D, 0712VA, 071BM, 071D, 071DGG, 071FT, 071FT04, 071FT06, 071FTR, 071FTRL, 071TP, 072D, 072DGG, 08WCP1GM, 08WFA4G, 08WFAAG, 08WFT1GV, 08WFT2GV, 08WFT3GV, 08WFT4GV, 08WFT6GV, 08WFT7GV, 090, 090BM, 090BM1G, 090FAVA, 090FT, 090FT04, 090FT05, 090FT1G...(Otros modelos se puede ver en la tienda web)		

 <p>1</p>			
código	100894	referencia	33A1100
descripción	contrasoporte para quemador piloto apto para serie 100		



 <p>1</p>			
código	100888	referencia	33A0980
descripción	perno roscado para quemador piloto		
Para modelos:	030FT, 030FTR, 031FT, 031FTR, 031FTRL, 070BM, 070FT, 070FT04, 070FT05, 070FTR, 0712VA, 071BM, 071FT, 071FT04, 071FT06, 071FTR, 071FTRL, 071TP, 090BM, 090FT, 090FTR, 091BM, 091FT, 091FTR, 091FTRL, 091TP, 30F, 30FS, 31, 31PD6, 31PI6, 31R, 31TC, 31TP, 32, 32TC, 32TP, 32TPV, 32V, 60SM, 70F, 712D, 712VA, 71AR, 71D, 71DGG, 71F, 71PD10, 71PD15, 71PI10...(Otros modelos se puede ver en la tienda web)		

 <p>1</p>			
código	100886	referencia	33A1000
descripción	portapilotos apto para serie 100 3 piezas		
Para modelos:	030FT, 030FTR, 031FT, 031FTR, 031FTRL, 070BM, 070FT, 070FTR, 0712VA, 071BM, 071FT, 071FTR, 071FTRL, 071TP, 08WFA4G, 08WFAAG, 08WFT1GV, 08WFT2GV, 08WFT3GV, 08WFT4GV, 08WFT6GV, 08WFT7GV, 090BM, 090FAVA, 090FT, 090FTR, 091BM, 091FT, 091FTR, 091FTRL, 091TP, 092VA, 092VAGG, 0A0FAVA, 0D0FAVA, 10WTPGE, 10WTPGV, 12WFA6G, 12WFAAG, 190FAB, 190TPO, 191BR1G, 191BR1GA, 191BR2G, 191BR2GA, 191FAAG, 191FABG, 191FADG, 191TPG, 1A0FA2...(Otros modelos se puede ver en la tienda web)		

 <p>1</p>			
código	100855	referencia	33S0950
descripción	portapilotos triple		
accesorios para	100855		
	código	100855	referencia 33S0950
	portapilotos triple		

Continúa en la página siguiente





accesorios para	100855		
	código	100886	referencia 33A1000
	portapilotos apto para serie 100 3 piezas		
	código	100888	referencia 33A0980
	perno roscado para quemador piloto		

específico del fabricante

	1		
código	100812	referencia	35R0100
descripción	portapilotos apto para serie 100		
Para modelos:	71PD10, 71PD15, 71PI10, 71PI10A, 91PI10, 91PI10A		

	1		
código	100850	referencia	35R1460
descripción	portapilotos apto para serie 100		
Para modelos:	06WCP1GM, 08WCP1GM, 090BM1G, 091CP1G, 0A0BMG, 0D0BMG, 0G0FR5G, 0G1CP1G, 0G1CP1G-VERS.2004, 190BM2G, 191CP2G, 191PD2G, 191PI1G, 191PI1GA, 191PI2G, 191PI2GA, 1A0BMG, 1D0BMG, 1G0FR6G, 1G0TP0, 1G1CP1G, 1G1CP1G-VERS.2004, 1G1CP2G, 1G1CP2G-VERS.2004, 1G1FA0G, 1G1FAPG, 1G1TP0G, 2G1FA0G, 2G1FADG, 2G1FADGV, 2G1FAPG, 2G1TP3G, G1FAGS, G1FAGST		

	1		
código	102968	referencia	35S0090
descripción	portapilotos apto para serie 100		

	1		
código	100168	referencia	35V9130
descripción	portapilotos SIT tipo serie 100		
Para modelos:	030, 031, 031TP, 032, 070D, 070DGG, 0712D, 0712VA, 071D, 071DGG, 072D, 072DGG, 090, 090GG, 091, 091GG, 092, 092GG, 092VA, 092VAGG, 0A0FAS, 0B0FAS, 0D0FAS, 1A0FAS, 1A0FAS2, 1A1FAS2G, 1A1FASG, 1B0FAS, 1B0FAS2, 1B1FAS2G, 1B1FASG, 1D0FAS, 1D0FAS2, 1D1FAS2G, 1D1FASG, 2A0FAS2, 2A1FAS2G, 2A1FASG, 2A1TPSG, 2D0FAS2, 2D1FAS2G, 2D1FASG, 2D1TPSG, 31, 31GE, 31TC, 31TP, 32, 32TC, 32TP...(Otros modelos se puede ver en la tienda web)		

	1		
código	100169	referencia	35S0690 35V9140
descripción	portapilotos SIT tipo serie 100		
Para modelos:	070D, 070DGG, 0712D, 0712VA, 071D, 071DGG, 072D, 072DGG, 090, 090GG, 091, 091GG, 092, 092GG, 092VA, 092VAGG, 0A0FAS, 0B0FAS, 0D0FAS, 1A0FAS, 1A0FAS2, 1A1FAS2G, 1A1FASG, 1B0FAS, 1B0FAS2, 1B1FAS2G, 1B1FASG, 1D0FAS, 1D0FAS2, 1D1FAS2G, 1D1FASG, 2A0FAS2, 2A1FAS2G, 2A1FASG, 2A1TPSG, 2D0FAS2, 2D1FAS2G, 2D1FASG, 2D1TPSG, 3A1FASG, 3D1FASG, 712D, 712VA, 71D, 71DGG, 71GE, 71GEGG, 72D, 72DGG, 72TP...(Otros modelos se puede ver en la tienda web)		

	1		
código	100184	referencia	35V2570
descripción	portapilotos SIT tipo serie 100		
Para modelos:	031FT04, 031FT06, 070FT04, 070FT05, 071FT04, 071FT06, 090FT04, 090FT05, 090FT1G, 090FT2G, 090FT4G, 090FT5G, 090FT7G, 091FT04, 091FT06, 0A0FT1G, 0A0FT2G, 0A0FT4G, 0A0FT5G, 0B0FT1G, 0B0FT2G, 0B0FT4G, 0B0FT5G, 0D0FT1G, 0D0FT2G, 0D0FT4G, 0D0FT5G, 0G0FT1G, 0G0FT1G-VERS.032008, 0G0FT2G, 0G0FT2G-VERS.032008, 0G0FT4G, 0G0FT4G-VERS.032008, 0G0FT5G, 0G0FT5G-VERS.032008, 0G0FT7G, 190FT15G, 190FT1G, 190FT2G, 190FT3G, 190FT42G, 190FT4G, 190FT6G, 190FT72G, 190FT7G, 1A0FT1G, 1A0FT2G, 1A0FT3G, 1A0FT4G, 1A0FT6G...(Otros modelos se puede ver en la tienda web)		

	1		
código	100185	referencia	35S5080
descripción	portapilotos SIT tipo serie 100		
Para modelos:	30CPS, 30F1, 30F1B, 30F52, 30F52B, 70CP, 70F1, 70F1B, 71CP, 71CP2, 71F2, 71F2B, 90CP, 90F110B, 91CP, 91F210, 91F210B, 91F223B		

	1		
código	100188	referencia	35R3540
descripción	portapilotos SIT tipo serie 100		
Para modelos:	0A1FR1G, 0A1FR1GD, 0B1FR1G, 0B1FR1GD, 0D1FR1G, 0D1FR1GD, 1A1FR2G, 1A1FR2GD, 1D1FR2G, 1D1FR2GD		



boquillas piloto			
			
código	102972	referencia	33T3130
descripción	boquilla de quemador piloto gas natural código 40 taladro ø 0.4mm UE 1 pzs		

			
código	100246	referencia	33T0410
descripción	boquilla de quemador piloto gas natural taladro ø 0.35mm UE 1 pzs rosca M8x0,75		

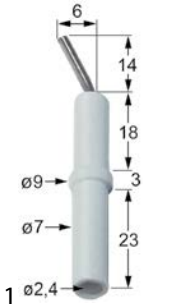

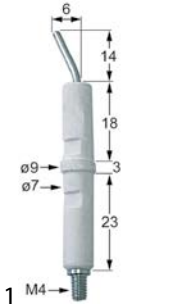



electródos de encendido			
			
código	100707	referencia	3232960
descripción	electrodo de encendido D1 ø 7mm D2 ø 9mm empalme ø2,4mm L1 14mm L2 6mm LC1 18mm LC2 3mm LC3 23mm para apretar UE 1 pzs		
Para modelos:	06WCP1GM, 08WCP1GM, 08WFA4G, 08WFAAG, 090BM1G, 090FAVA, 090FT1G, 090FT2G, 090FT4G, 090FT5G, 090FT7G, 091CP1G, 091FR1G, 091FR1GD, 091FR3G, 091FR3GD, 0G0FT1G-VERS.032008, 0G0FT2G-VERS.032008, 0G0FT4G-VERS.032008, 0G0FT5G-VERS.032008, 0G0FT7G, 0G1CP1G-VERS.2004, 0G1FR3G, 0G1FR3GD, 0G1FR7G, 10WTPGE, 10WTPGV, 12WFA6G, 12WFAAG, 190BM2G, 190FAB, 190FT15G, 190FT1G, 190FT2G, 190FT3G, 190FT42G, 190FT4G, 190FT6G, 190FT72G, 190FT7G, 190TP0, 191BR1G, 191BR1GA, 191BR2G, 191BR2GA, 191CP2G, 191FAAG, 191FABG, 191FADG, 191FR2G...(Otros modelos se puede ver en la tienda web)		















			
código	100706	referencia	32T0320
descripción	electrodo de encendido empalme M4 UE 1 pzs		
Para modelos:	191CP1GA, 1A1CP1GA, 1A1PI2G, 1A1PI2GA, 1D1CP1GA, 1D1PI2G, 1D1PI2GA, 291PD3G, 291PI3G, 2A1PD3G, 2A1PI3G, 2D1PI3G		



otros			
			
código	100885	referencia	33A0970
descripción	casquillo de mezcla de aire para quemador piloto UE 1 pzs		
Para modelos:	030, 030FT, 030FTR, 031, 031FT, 031FT04, 031FT06, 031FTR, 031FTRL, 031TP, 032, 06WCP1GM, 06WFR3GD, 070BM, 070D, 070DGG, 070FT, 070FT04, 070FT05, 070FTR, 0712D, 0712VA, 071BM, 071D, 071DGG, 071FT, 071FT04, 071FT06, 071FTR, 071FTRL, 071TP, 072D, 072DGG, 08WCP1GM, 08WFA4G, 08WFAAG, 08WFT1GV, 08WFT2GV, 08WFT3GV, 08WFT4GV, 08WFT6GV, 08WFT7GV, 090, 090BM, 090BM1G, 090FAVA, 090FT, 090FT04, 090FT05, 090FT1G...(Otros modelos se puede ver en la tienda web)		















serie 160			
			
código	100109	referencia	33A1630
descripción	piloto de encendido SIT tipo serie 160 1 llama boquilla ømm empalme de gasmm		
Para modelos:	08WGRGV, 090GRG, 0A0GRG, 0D0GRG, 190GRG, 1A0GRG, 1D0GRG, 1G0GRG, 6042120-08WGRGV		
repuestos para	100109	código	100907
		referencia	—
	unión roscada rosca M10x1 UE 1 pzs tipo SEF 1 ømm para termopar		
accesorios para	100109	código	100202
		referencia	—
	boquilla de quemador piloto gas natural código 41 UE 1 pzs boquilla ø 0.41mm		
		código	100203
		referencia	—
	boquilla de quemador piloto gas licuado código 25 UE 1 pzs boquilla ø 0.25mm		
		código	100701
		referencia	32T0190
	electrodo de encendido empalme M4 UE 1 pzs		
		código	100801
		referencia	—
	junta para quemador piloto UE 1 pzs		
		código	100869
		referencia	—
	boquilla de quemador piloto gas natural código 51 UE 1 pzs apto para serie 160 boquilla ø 0.51mm		
		código	100906
		referencia	36Q1050
	unión roscada rosca M10x1 para electrodo de encendido latón UE 1 pzs EC 10		
		código	100908
		referencia	36Q1000
	tornillo de racor rosca M10x1 para tuboø 4mm UE 1 pzs		
		código	100909
		referencia	36Q0060
	tornillo de racor rosca M10x1 para tuboø 6mm UE 1 pzs		
		código	101282
		referencia	—
	anillo cortante para tuboø 4mm L 7.4mm UE 1 pzs		
		código	101287
		referencia	36Q0150
	anillo cortante para tuboø 6mm UE 1 pzs		

Continúa en la página siguiente















accesorios para	100109			
	102110	referencia	—	
	tubo piloto cobre diámetro ø 4mm grosor de la pared 1mm L 3000mm			
	102111	referencia	—	
	tubo piloto cobre diámetro ø 6mm grosor de la pared 1mm L 3000mm			
	107650	referencia	33T3310	
	boquilla de quemador piloto SIT gas licuado código 30 UE 1 pzs			

	1			
código	100053	referencia	33A0750	
descripción	pilotaje de encendido SIT tipo serie 160 2 llamas boquilla ømm empalme de gasmm			
Para modelos:	1A1PD1G, 1A1PD2G, 1A1PI1G, 1A1PI1GA, 1D1PD1G, 1D1PD2G, 1D1PI1G, 1D1PI1GA			
repuestos para	100053			
	código	100907	referencia	—
	unión roscada rosca M10x1 UE 1 pzs tipo SEF 1 ømm para termopar			
accesorios para	100053			
	código	100202	referencia	—
	boquilla de quemador piloto gas natural código 41 UE 1 pzs boquilla ø 0.41mm			
	código	100203	referencia	—
	boquilla de quemador piloto gas licuado código 25 UE 1 pzs boquilla ø 0.25mm			
	código	100701	referencia	32T0190
	electrodo de encendido empalme M4 UE 1 pzs			
	código	100801	referencia	—
	junta para quemador piloto UE 1 pzs			
	código	100869	referencia	—
	boquilla de quemador piloto gas natural código 51 UE 1 pzs apto para serie 160 boquilla ø 0.51mm			
	código	100906	referencia	36Q1050
	unión roscada rosca M10x1 para electrodo de encendido latón UE 1 pzs EC 10			
	código	100908	referencia	36Q1000
	tornillo de racor rosca M10x1 para tubo ø 4mm UE 1 pzs			
	código	100909	referencia	36Q0060
	tornillo de racor rosca M10x1 para tubo ø 6mm UE 1 pzs			
	código	101282	referencia	—
	anillo cortante para tubo ø 4mm L 7.4mm UE 1 pzs			
	código	101287	referencia	36Q0150
	anillo cortante para tubo ø 6mm UE 1 pzs			
	código	102110	referencia	—
	tubo piloto cobre diámetro ø 4mm grosor de la pared 1mm L 3000mm			
	código	102111	referencia	—
	tubo piloto cobre diámetro ø 6mm grosor de la pared 1mm L 3000mm			

accesorios para	100053			
	107650	referencia	33T3310	
	boquilla de quemador piloto SIT gas licuado código 30 UE 1 pzs			

	1			
código	100054	referencia	33A0880	
descripción	pilotaje de encendido SIT tipo serie 160 2 llamas boquilla ømm empalme de gasmm			
Para modelos:	0A1CP1G, 0B1CP1G, 0D1CP1G, 191CP1G, 1A1CP1G, 1A1CP2G, 1D1CP1G, 1D1CP2G			
repuestos para	100054			
	código	100907	referencia	—
	unión roscada rosca M10x1 UE 1 pzs tipo SEF 1 ømm para termopar			
accesorios para	100054			
	código	100202	referencia	—
	boquilla de quemador piloto gas natural código 41 UE 1 pzs boquilla ø 0.41mm			
	código	100203	referencia	—
	boquilla de quemador piloto gas licuado código 25 UE 1 pzs boquilla ø 0.25mm			
	código	100701	referencia	32T0190
	electrodo de encendido empalme M4 UE 1 pzs			
	código	100801	referencia	—
	junta para quemador piloto UE 1 pzs			
	código	100869	referencia	—
	boquilla de quemador piloto gas natural código 51 UE 1 pzs apto para serie 160 boquilla ø 0.51mm			
	código	100906	referencia	36Q1050
	unión roscada rosca M10x1 para electrodo de encendido latón UE 1 pzs EC 10			
	código	100908	referencia	36Q1000
	tornillo de racor rosca M10x1 para tubo ø 4mm UE 1 pzs			
	código	100909	referencia	36Q0060
	tornillo de racor rosca M10x1 para tubo ø 6mm UE 1 pzs			
	código	101282	referencia	—
	anillo cortante para tubo ø 4mm L 7.4mm UE 1 pzs			
	código	101287	referencia	36Q0150
	anillo cortante para tubo ø 6mm UE 1 pzs			
	código	102110	referencia	—
	tubo piloto cobre diámetro ø 4mm grosor de la pared 1mm L 3000mm			
	código	102111	referencia	—
	tubo piloto cobre diámetro ø 6mm grosor de la pared 1mm L 3000mm			
	código	107650	referencia	33T3310
	boquilla de quemador piloto SIT gas licuado código 30 UE 1 pzs			



JUNKERS			
serie CB 503			
pilotos de encendido			
			
código	100058	referencia	33A0470
descripción	piloto de encendido JUNKERS tipo CB503006 gas natural boquilla N° 26 empalme de gas 4mm		
repuestos para	100058		
	código	100224	referencia 33T0560
	boquilla de quemador piloto gas natural presión de gas 25mbar código 26 UE 1 pzs apto para JUNKERS CB503_		
	código	101281	referencia —
	anillo cortante para tuboø 4mm L 8.7mm UE 1 pzs apto para CB 502/503		
	código	101283	referencia —
	tornillo de racor rosca M10x1 para tuboø 4mm UE 1 pzs		
accesorios para	100058		
	código	100220	referencia 33T0540
	boquilla de quemador piloto gas licuado presión de gas 50mbar código 2 UE 1 pzs apto para JUNKERS CB503_		
	código	100221	referencia —
	boquilla de quemador piloto gas licuado presión de gas 30mbar código 29 UE 1 pzs apto para JUNKERS CB50203_		
	código	100222	referencia —
	boquilla de quemador piloto gas licuado presión de gas 50mbar código 5 UE 1 pzs apto para JUNKERS CB50203_		
	código	100223	referencia —
	boquilla de quemador piloto gas natural presión de gas 20mbar código 3 UE 1 pzs apto para JUNKERS CB503_		
	código	100226	referencia —
	boquilla de quemador piloto gas licuado presión de gas 50mbar código 15 apto para JUNKERS		
	código	100227	referencia —
	boquilla de quemador piloto gas natural presión de gas 25mbar código 6 UE 1 pzs apto para JUNKERS CB50203_		
	código	100228	referencia —
	boquilla de quemador piloto gas ciudad presión de gas 8mbar código 4 UE 1 pzs apto para JUNKERS CB50203_		
	código	100909	referencia 36Q0060
	tornillo de racor rosca M10x1 para tuboø 6mm UE 1 pzs		
	código	101287	referencia 36Q0150
	anillo cortante para tuboø 6mm UE 1 pzs		
	código	102110	referencia —
	tubo piloto cobre diámetro ø 4mm grosor de la pared 1mm L 3000mm		
	código	102111	referencia —
	tubo piloto cobre diámetro ø 6mm grosor de la pared 1mm L 3000mm		

pilotos de encendido específicos del fabricante			
ANGELO PO			
serie Junior / Senior			
			
código	100187	referencia	6000280
descripción	piloto de encendido SIT tipo serie 100 3 llamas boquilla ø 0.25mm empalme de gasmm		
Para modelos:	30F, 30FS, 70F, 71F		
repuestos para	100187		
	código	100835	referencia 32Z2241
	parte superior de quemador piloto 3 llamas apto para serie 100 H 35mm L 48mm UE 1 pzs An 52mm		
	código	100855	referencia 33S0950
	portapilotos triple		
	código	100882	referencia —
	parte inferior de quemador piloto PRO-GAS serie 100 boquilla ø 0.25mm		
	código	100885	referencia 33A0970
	casquillo de mezcla de aire para quemador piloto UE 1 pzs		
	código	100916	referencia —
	resorte de compresión para quemador piloto UE 1 pzs		
	código	100917	referencia —
	junta para quemador piloto UE 1 pzs aluminio		
	código	100918	referencia —
	tornillo para quemador piloto		
	código	102742	referencia —
	boquilla de quemador piloto gas licuado código 25 taladro ø 0.25mm UE 1 pzs		
accesorios para	100187		
	código	100245	referencia —
	boquilla de quemador piloto gas licuado código 20 taladro ø 0.2mm UE 1 pzs rosca M8x0,75		
	código	100246	referencia 33T0410
	boquilla de quemador piloto gas natural taladro ø 0.35mm UE 1 pzs rosca M8x0,75		
	código	100881	referencia —
	parte inferior de quemador piloto PRO-GAS serie 100 boquilla ø 0.2mm		
	código	100883	referencia —
	parte inferior de quemador piloto PRO-GAS serie 100 boquilla ø 0.35mm		
	código	100904	referencia —
	tornillo de apriete M10x1 para tuboø 4mm UE 1 pzs		

Continúa en la página siguiente





accesorios para	100187			
	código	100905	referencia	—
	tornillo de apriete M10x1 para tuboø 6mm UE 1 pzs			





serie Combi / Major



código	100065	referencia	6000170
descripción	piloto de encendido 1 llama empalme de gasmm sin boquilla		
repuestos para	100065		
	código	100831	referencia —
	cabezal de quemador piloto UE 1 pzs		
accesorios para	100065		
	código	100240	referencia 33T0240
	boquilla de quemador piloto gas licuado código 39 presión de gas 30mbar latón		
	código	100241	referencia 33T0050
	boquilla de quemador piloto gas natural código 13 presión de gas 25mbar taladro ø 0.4mm UE 1 pzs latón		
	código	100909	referencia 36Q0060
	tornillo de racor rosca M10x1 para tuboø 6mm UE 1 pzs		
	código	101282	referencia —
	anillo cortante para tuboø 4mm L 7.4mm UE 1 pzs		
	código	101283	referencia —
	tornillo de racor rosca M10x1 para tuboø 4mm UE 1 pzs		
	código	101288	referencia —
	anillo cortante para tuboø 6mm L 6mm aluminio UE 1 pzs ø ext. 8.5mm		





código	101777	referencia	34A0010
descripción	piloto de encendido empalme de gasmm sin boquilla		
accesorios para	101777		
	código	100240	referencia 33T0240
	boquilla de quemador piloto gas licuado código 39 presión de gas 30mbar latón		
	código	100241	referencia 33T0050
	boquilla de quemador piloto gas natural código 13 presión de gas 25mbar taladro ø 0.4mm UE 1 pzs latón		

accesorios para	101777		
	código	100831	referencia —
	cabezal de quemador piloto UE 1 pzs		
	código	100909	referencia 36Q0060
	tornillo de racor rosca M10x1 para tuboø 6mm UE 1 pzs		
	código	101282	referencia —
	anillo cortante para tuboø 4mm L 7.4mm UE 1 pzs		
	código	101283	referencia —
	tornillo de racor rosca M10x1 para tuboø 4mm UE 1 pzs		
	código	101288	referencia —
	anillo cortante para tuboø 6mm L 6mm aluminio UE 1 pzs ø ext. 8.5mm		

serie nuevas



código	107541	referencia	N/A
descripción	piloto de encendido 2 llamas empalme de gas 4/6mm sin boquilla		
accesorios para	107541		
	código	100240	referencia 33T0240
	boquilla de quemador piloto gas licuado código 39 presión de gas 30mbar latón		
	código	100241	referencia 33T0050
	boquilla de quemador piloto gas natural código 13 presión de gas 25mbar taladro ø 0.4mm UE 1 pzs latón		

otros



código	104299	referencia	3060930
descripción	piloto de encendido		
Para modelos:	190FA, 190FAD, 191FADG, 191FAE, 191FAG, 290FA, 291FAG, 291FAGF, 391FAG		



electródos

código	100712	referencia	32T0080
descripción	electrodo de encendido D1 ø 6mm L1 5mm L2 5mm LC1 23mm LC2 11mm LC3 23mm empalme F 2,8x0,8mm M12x1		

código	100798	referencia	32T0010 32T0060
descripción	electrodo de encendido D1 ø 6x7mm empalme F 2,8x0,8mm D2 ø 6x6mm L1 15mm L2 10mm LC1 14mm LC2 17mm LC3 14mm para apretar		
Para modelos:	030FT, 030FTR, 031FT, 031FT04, 031FT06, 031FTR, 031FTRL, 031TP, 06WCP1GM, 06WFR3GD, 070BM, 070FT, 070FT04, 070FT05, 070FTR, 0712VA, 071BM, 071FT, 071FT04, 071FT06, 071FTR, 071FTRL, 071TP, 08WCP1GM, 08WFA4G, 08WFAAG, 08WFT1GV, 08WFT2GV, 08WFT3GV, 08WFT4GV, 08WFT6GV, 08WFT7GV, 090BM, 090BM1G, 090FAVA, 090FT, 090FT04, 090FT05, 090FT1G, 090FT2G, 090FT4G, 090FT5G, 090FT7G, 090FTR, 091BM, 091CP1G, 091FR1G, 091FR1GD, 091FR3G, 091FR3GD...(Otros modelos se puede ver en la tienda web)		

código	100736	referencia	32T0141 32T0142
descripción	electrodo de encendido D1 ø 6x7mm empalme F 2,8x0,8mm LC1 14mm LC2 16mm LC3 14mm		
Para modelos:	030FT, 030FTR, 031FT, 031FT04, 031FT06, 031FTR, 031FTRL, 031TP, 06WCP1GM, 06WFR3GD, 070BM, 070FT, 070FT04, 070FT05, 070FTR, 0712VA, 071BM, 071FT, 071FT04, 071FT06, 071FTR, 071FTRL, 071TP, 08WCP1GM, 08WFAAG, 08WFT1GV, 08WFT2GV, 08WFT3GV, 08WFT4GV, 08WFT6GV, 08WFT7GV, 090BM, 090FAVA, 090FT, 090FT04, 090FT05, 090FT1G, 090FT2G, 090FT4G, 090FT5G, 090FT7G, 090FTR, 091BM, 091CP1G, 091FR1G, 091FR1GD, 091FR3G, 091FR3GD, 091FT, 091FT04...(Otros modelos se puede ver en la tienda web)		

código	100708	referencia	32T0140
descripción	electrodo de encendido D1 ø 6x7mm empalme M4 D2 ø 6x6mm L1 11mm L2 5mm LC1 15mm LC2 16mm LC3 23mm		
Para modelos:	71AR, 91AR, FS30		

código	100707	referencia	3232960
descripción	electrodo de encendido D1 ø 7mm D2 ø 9mm empalme ø2,4mm L1 14mm L2 6mm LC1 18mm LC2 3mm LC3 23mm para apretar UE 1 pzs		
Para modelos:	06WCP1GM, 08WCP1GM, 08WFA4G, 08WFAAG, 090BM1G, 090FAVA, 090FT1G, 090FT2G, 090FT4G, 090FT5G, 090FT7G, 091CP1G, 091FR1G, 091FR1GD, 091FR3G, 091FR3GD, 0G0FT1G-VERS.032008, 0G0FT2G-VERS.032008, 0G0FT4G-VERS.032008, 0G0FT5G-VERS.032008, 0G0FT7G, 0G1CP1G-VERS.2004, 0G1FR3G, 0G1FR3GD, 0G1FR7G, 10WTPGE, 10WTPGV, 12WFA6G, 12WFAAG, 190BM2G, 190FAB, 190FT15G, 190FT1G, 190FT2G, 190FT3G, 190FT42G, 190FT4G, 190FT6G, 190FT72G, 190FT7G, 190TP0, 191BR1G, 191BR1GA, 191BR2G, 191BR2GA, 191CP2G, 191FAAG, 191FABG, 191FADG, 191FR2G...(Otros modelos se puede ver en la tienda web)		

código	100701	referencia	32T0190
descripción	electrodo de encendido empalme M4 UE 1 pzs		
Para modelos:	08WGRGV, 090GRG, 0A0GRG, 0A1CP1G, 0B1CP1G, 0D0GRG, 0D1CP1G, 190GRG, 191CP1G, 1A0GRG, 1A1CP1G, 1A1CP2G, 1A1PD1G, 1A1PD2G, 1A1PI1G, 1A1PI1GA, 1D0GRG, 1D1CP1G, 1D1CP2G, 1D1PD1G, 1D1PD2G, 1D1PI1G, 1D1PI1GA, 1G0GRG, 6042120-08WGRGV		
accesorios para	100701	código	100906
		referencia	36Q1050
	unión roscada rosca M10x1 para electrodo de encendido latón UE 1 pzs EC 10		

1 componentes gas

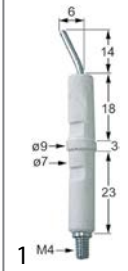

código	100706	referencia	32T0320
descripción	electrodo de encendido empalme M4 UE 1 pzs		
Para modelos:	191CP1GA, 1A1CP1GA, 1A1PI2G, 1A1PI2GA, 1D1CP1GA, 1D1PI2G, 1D1PI2GA, 291PD3G, 291PI3G, 2A1PD3G, 2A1PI3G, 2D1PI3G		



código	103287	referencia	6300746
descripción	electrodo de encendido Kit longitud brida 56mm anchura brida 22mm D1 ø 3mm D2 ø 9.5mm distancia de sujeción 47mm		
Para modelos:	BX101G, BX101G-VERS.122013, BX61G, BX61G-VERS.122013, FX101G1, FX101G1R, FX101G2, FX101G2C, FX101G2C-VERS.032014, FX101G2R, FX101G2R-VERS.032014, FX101G2-VERS.032014, FX101G3, FX101G3C, FX101G3C-VERS.022014, FX101G3R, FX101G3R-VERS.022014, FX101G3-VERS.022014, FX10G2CR, FX10G2CR-VERS.032014, FX10G3CR, FX10G3CR-VERS.022014, FX201G2, FX201G2P, FX201G2P-VERS.032014, FX201G2-VERS.032014, FX201G3P, FX201G3-VERS.022014, FX61G1, FX61G1R, FX61G2, FX61G2C, FX61G2C, FX61G2CR-VERS.032014, FX61G2C-VERS.032014, FX61G2R, FX61G2R-VERS.032014, FX61G2-VERS.032014, FX61G3, FX61G3C, FX61G3CR, FX61G3CR-VERS.022014, FX61G3C-VERS.022014, FX61G3R, FX61G3R-VERS.022014, FX61G3-VERS.022014		



código	106743	referencia	6300568
descripción	electrodo de encendido longitud brida 55mm anchura brida 55mm D1 ø 9.3mm D2 ø 5.85mm L1 80mm LC1 80mm LC2 33.5mm LC3 29.5mm LC4 24.5mm con brida de sujeción con material de montaje ø empalme 4mm		
Para modelos:	FC1221G, FM1221G1, FM1221G1-VERS.2006, FM1221G2, FM1221G2-VERS.2006, FM1221G3, FM1221G3-VERS.2006, FM2021G1, FM2021G2, FM2021G2-VERS.2006, FM2021G3, FM2021G3-VERS.2006, FM721G1, FM721G1-VERS.2006, FM721G2, FM721G2-VERS.2006, FM721G3, FM721G3-VERS.2006		

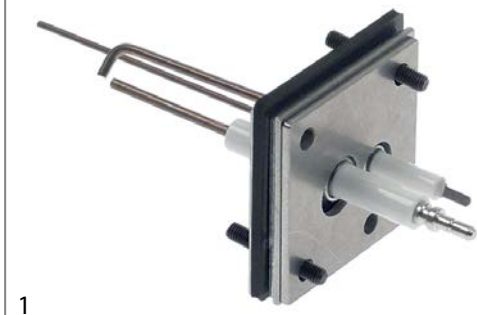

código	104801	referencia	6300567
descripción	electrodo de encendido longitud brida 55mm anchura brida 55mm D1 ø 9mm D2 ø 7mm L1 118mm L2 145mm LC1 77mm LC2 65mm		
Para modelos:	FC1011G, FC611G, FM1011G1, FM1011G1-VERS.2006, FM1011G2, FM1011G2-VERS.2006, FM1011G3, FM1011G3-VERS.2006, FM2011G2-VERS.2006, FM2011G3-VERS.2006, FM611G1, FM611G1-VERS.2006, FM611G2, FM611G2-VERS.2006, FM611G3, FM611G3-VERS.2006		

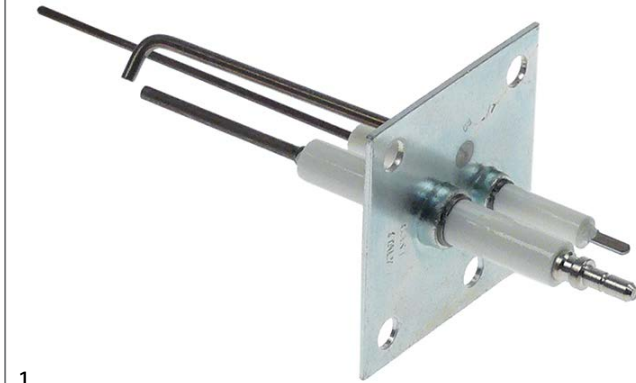

código	104800	referencia	32V4670
descripción	electrodo de encendido longitud brida 55mm anchura brida 55mm D1 ø 9mm D2 ø 7mm L1 119mm L2 145mm LC1 60mm LC2 55mm		



código	104683	referencia	3106670 3106671
descripción	electrodo de encendido longitud brida 56mm anchura brida 22mm		
Para modelos:	091FR11, 091FR11A, 091FR11D, 091FR11D-VERS.052012, 091FR11-VERS.032012, 091FR7G, 091FR7GX, 191FR21, 191FR21D, 191FR21D-VERS.092012, 191FR21-VERS.032012		



código	104799	referencia	6300747
descripción	electrodo de encendido longitud brida 56mm anchura brida 22mm D1 ø 9x62mm D2 ø 9x62mm L1 130mm L2 140mm		
Para modelos:	BX122G, BX122G-VERS.122013, BX82G, BX82G-VERS.122013, FX122G1, FX122G2, FX122G2C, FX122G2T, FX122G2T-VERS.032014, FX122G3, FX122G3C, FX122G3T, FX122G3T-VERS.022014, FX12G3CT, FX12G3CT-VERS.022014, FX202G2, FX202G2-VERS.032014, FX202G3, FX202G3-VERS.022014, FX82G1, FX82G2, FX82G2C, FX82G2T, FX82G2T-VERS.032014, FX82G3, FX82G3C, FX82G3CT, FX82G3CT-VERS.022014, FX82G3T, FX82G3T-VERS.022014		

código	100906	referencia	36Q1050
descripción	unión roscada rosca M10x1 para electrodo de encendido latón UE 1 pzs EC 10		
Para modelos:	08WGRGV, 090GRG, 0A0GRG, 0A1CP1G, 0B1CP1G, 0D0GRG, 0D1CP1G, 190GRG, 191CP1G, 1A0GRG, 1A1CP1G, 1A1CP2G, 1A1PD1G, 1A1PD2G, 1A1PI1G, 1A1PI1GA, 1D0GRG, 1D1CP1G, 1D1CP2G, 1D1PD1G, 1D1PD2G, 1D1PI1G, 1D1PI1GA, 1G0GRG, 6042120-08WGRGV		

cables de encendido

cables prefabricados

código	100190	referencia	32A0061 32A0390
descripción	cable de encendido longitud del cable 1200mm empalme F2,8mm / F2,8mm		
Para modelos:	06WFR3GD, 071TP, 08WFAAG, 08WFT1GV, 08WFT2GV, 08WFT3GV, 08WFT4GV, 08WFT6GV, 08WFT7GV, 090FAVA, 091FR1G, 091FR1GD, 091FR3G, 091FR3GD, 091TP, 0A1FR1G, 0A1FR1GD, 0A1FR1GD-VERS.2004, 0A1FR1G-VERS.2004, 0A1FR3G, 0A1FR3GD, 0B1FR1G, 0B1FR1GD, 0D1FR1G, 0D1FR1GD, 0D1FR1GD-VERS.2004, 0D1FR1G-VERS.2004, 0D1FR3G, 0D1FR3GD, 0G1FR3G, 0G1FR3GD, 10WFR4GD, 12WFAAG, 190FAB, 191BR1G, 191BR1GA, 191BR2G, 191BR2GA, 191CP1GA, 191FABG, 191FR2G, 191FR2GD, 191FR4G, 191FR4GD, 1A1BR1G, 1A1BR1GA, 1A1BR2G, 1A1BR2GA, 1A1CP1GA, 1A1FR2G... (Otros modelos se puede ver en la tienda web)		

código	100179	referencia	32A2540
descripción	cable de encendido longitud del cable 1200mm empalme F2,8mm / ø2,4mm		
Para modelos:	08WGRGV, 090GRG, 0A0BMG, 0A0FAVA, 0D0BMG, 0D0FAVA, 0G0FR5G, 0G1CP1G, 0G1CP1G-VERS.2004, 0G1FR7G, 190GRG, 191CP1G, 1A0BMG, 1A0FA2, 1A0FAS, 1A0FAB, 1A0FAS2, 1A0TP0, 1A1FA2G, 1A1FASG, 1A1FABG, 1A1FAS2G, 1A1FASG, 1A1TP0G, 1A1TP0G-VERS.2002, 1B0FAS2, 1B0TP0, 1B1FAS2G, 1D0BMG, 1D0FA2, 1D0FAS, 1D0FAB, 1D0FAS2, 1D0TP0, 1D1FA2G, 1D1FASG, 1D1FABG, 1D1FAS2G, 1D1FASG, 1D1TP0G, 1D1TP0G-VERS.2002, 1G0FR6G, 1G1CP1G, 1G1CP1G-VERS.2004, 1G1CP2G, 1G1CP2G-VERS.2004, 1G1FR8G, 2A0FAS2, 2A1FAS2G, 2A1FASG... (Otros modelos se puede ver en la tienda web)		

código	102163	referencia	32A3080
descripción	cable de encendido longitud del cable 1500mm empalme F2,8mm / ø2,4mm		
Para modelos:	08WFA4G, 12WFA6G, 190TP0, 191FAAG, 191FADG, 191FAG, 191PD2G, 191PI1G, 191PI1GA, 191PI2G, 191PI2GA, 191TPG, 1G1FA0G, 1G1FAPG, 1G1TP0G, 291FAG, 291TPCG, 2A1PI3G, 2D1PI3G, 2G1FA0G, 2G1FADG, 2G1FADGV, 2G1FAPG, 2G1TP3G, 391FAG		

código	100189	referencia	3059160 32A1640
descripción	cable de encendido longitud del cable 150mm empalme F2,8mm / ojal M4		
Para modelos:	090FT1G, 090FT2G, 090FT4G, 090FT5G, 090FT7G, 090GRG, 091CP1G, 091FR1G, 091FR1GD, 091FR3G, 091FR3GD, 0A1FR1G, 0A1FR1GD, 0A1FR1GD-VERS.2004, 0A1FR1G-VERS.2004, 0A1FR3G, 0A1FR3GD, 0B1FR1G, 0B1FR1GD, 0D1FR1G, 0D1FR1GD, 0D1FR1GD-VERS.2004, 0D1FR1G-VERS.2004, 0D1FR3G, 0D1FR3GD, 0G1FR3G, 0G1FR3GD, 10WTPGE, 191BR1G, 191BR1GA, 191BR2G, 191BR2GA, 1A1BR1G, 1A1BR1GA, 1A1BR2G, 1A1BR2GA, 1D1BR1G, 1D1BR1GA, 1D1BR2G, 1D1BR2GA, 1G1FR4G, 1G1FR4GD, 291BR1G, 291BR1GA, 291BR2G, 291BR2GA, 2A1BR1G, 2A1BR1GA, 2A1BR2G, 2A1BR2GA... (Otros modelos se puede ver en la tienda web)		

código	103353	referencia	3113510
descripción	cable de encendido longitud del cable 350mm empalme F2,8/F6,3		
Para modelos:	FC1011G, FC611G, FM1011G1, FM1011G1-VERS.2006, FM1011G2, FM1011G2-VERS.2006, FM1011G3, FM1011G3-VERS.2006, FM2011G2-VERS.2006, FM2011G3-VERS.2006, FM611G1, FM611G1-VERS.2006, FM611G2, FM611G2-VERS.2006, FM611G3, FM611G3-VERS.2006, FM721G1, FM721G1-VERS.2006, FM721G2, FM721G2-VERS.2006, FM721G3, FM721G3-VERS.2006		

código	100036	referencia	32A0040 32A0050
descripción	cable de encendido longitud del cable 500mm empalme F2,8mm / F2,8mm		





			
código	103352	referencia	3113490
descripción	cable de encendido longitud del cable 550mm empalme F2,8mm / F6,3mm		
Para modelos:	FM1221G1, FM1221G1-VERS.2006, FM1221G2, FM1221G2-VERS.2006, FM1221G3, FM1221G3-VERS.2006, FM2021G1, FM2021G2, FM2021G2-VERS.2006, FM2021G3, FM2021G3-VERS.2006, FM721G1, FM721G2, FM721G3, FX201G2, FX201G2P, FX201G2P-VERS.032014, FX201G2-VERS.032014, FX201G3P, FX201G3-VERS.022014, FX202G2, FX202G2-VERS.032014, FX202G3, FX202G3-VERS.022014		

			
código	102159	referencia	32A0140
descripción	cable de encendido longitud del cable 600mm empalme F2,8mm / F2,8mm		

			
código	100197	referencia	32A0430
descripción	cable de encendido longitud del cable 600mm empalme F2,8mm / ø2,4mm		
Para modelos:	031FT04, 031FT06, 070FT04, 070FT05, 071FT04, 071FT06, 090FT04, 090FT05, 091FT04, 091FT06, 0A0FT1G, 0A0FT2G, 0A0FT4G, 0A0FT5G, 0B0FT1G, 0B0FT2G, 0B0FT4G, 0B0FT5G, 0D0FT1G, 0D0FT2G, 0D0FT4G, 0D0FT5G, 0G0FT1G, 0G0FT1G-VERS.032008, 0G0FT2G, 0G0FT2G-VERS.032008, 0G0FT4G, 0G0FT4G-VERS.032008, 0G0FT5G, 0G0FT5G-VERS.032008, 1A0FT1G, 1A0FT2G, 1A0FT3G, 1A0FT4G, 1A0FT6G, 1B0FT1G, 1B0FT2G, 1B0FT3G, 1B0FT4G, 1B0FT6G, 1D0FT1G, 1D0FT2G, 1D0FT3G, 1D0FT4G, 1D0FT6G, 1G0FT1G, 1G0FT1G-VERS.032008, 1G0FT2G, 1G0FT2G-VERS.032008, 1G0FT3G...(Otros modelos se puede ver en la tienda web)		

			
código	100025	referencia	32A0051
descripción	cable de encendido longitud del cable 600mm empalme ø4mm / F6,3mm		

			
código	107550	referencia	3211850
descripción	cable de encendido longitud del cable 700mm empalme ø4mm / F2,8mm con cable de tierra		
Para modelos:	091FR11, 091FR11A, 091FR11D, 091FR11D-VERS.052012, 091FR11-VERS.032012, 191FR21, 191FR21D, 191FR21D-VERS.092012, 191FR21-VERS.032012		

			
código	100037	referencia	32A0010 32A0060 32A0210
descripción	cable de encendido longitud del cable 900mm empalme F2,8mm / F2,8mm		
Para modelos:	030FT, 030FTR, 031FT, 031FTR, 031FTRL, 031TP, 070BM, 070FT, 070FTR, 0712VA, 071BM, 071FT, 071FTR, 071FTRL, 090BM, 090BM1G, 090FT, 090FTR, 091BM, 091FT, 091FTR, 091FTRL, 092VA, 092VAGG, 135PVX, 190BM2G, 1G0TP0, 1G1TP0G, 2G1TP3G, 30CPS, 30F, 30FS, 31TP, 32TP, 32TPV, 70CP, 70F, 712D, 712VA, 71CP2, 71D, 71DGG, 71F, 71TP, 72D, 72DGG, 72TP, 72TPGG, 72VA, 72VAGG...(Otros modelos se puede ver en la tienda web)		

			
código	103307	referencia	32A2541
descripción	cable de encendido longitud del cable 900mm empalme F2,8mm / ø2,4mm		
Para modelos:	06WCP1GM, 08WCP1GM, 08WGRGV, 090FAA, 090FT1G, 090FT2G, 090FT4G, 090FT5G, 090FT7G, 090GRG, 091CP1G, 0A0BMG, 0A0FAVA, 0D0BMG, 0D0FAVA, 0G0FR5G, 0G1CP1G, 0G1CP1G-VERS.2004, 0G1FR7G, 10WTPGV, 190FAA, 190FT15G, 190FT1G, 190FT2G, 190FT3G, 190FT42G, 190FT4G, 190FT6G, 190FT72G, 190FT7G, 190GRG, 191CP1G, 191CP2G, 1A0BMG, 1A0FA2, 1A0FA5, 1A0FAB, 1A0FAS2, 1A0TP0, 1A1FA2G, 1A1FA5G, 1A1FABG, 1A1FAS2G, 1A1FASG, 1A1TP0G, 1A1TP0G-VERS.2002, 1B0FAS2, 1B0TP0, 1B1FAS2G, 1D0BMG...(Otros modelos se puede ver en la tienda web)		

			
código	100016	referencia	32A2550
descripción	cable de encendido longitud del cable 900mm empalme ø2,4mm / ø2,4mm		
Para modelos:	0A1CP1G, 0B1CP1G, 0D1CP1G, 0G1CP1G-VERS.2004, 0G1FR7G, 1A1CP1G, 1A1CP2G, 1A1PD1G, 1A1PD2G, 1A1PI1G, 1A1PI1GA, 1D1CP1G, 1D1CP2G, 1D1PD1G, 1D1PD2G, 1D1PI1G, 1D1PI1GA, 1G0FR6G, 1G1CP1G-VERS.2004, 1G1CP2G-VERS.2004, 1G1FR8G, 1G1PD1G, 1G1PI1G		

diversos



			
código	102986	referencia	32A1600
descripción	cable de encendido 1000Ohm		
Para modelos:	FCV101DM, FCV101DS, FCV141DM, FCV141DS, FCV241DM, FCV241DS, FCV241GDM, FCV241GDS, FCV401DM, FCV61DM, FCV61DS		

encendedores piezoeléctricos

diámetro de montaje 18mm

			
código	100002	referencia	32T0130
descripción	encendedor piezoeléctrico cuerpo metal giratorio montaje ø 18mm empalme F2,8x0,8		
Para modelos:	030FT, 030FTR, 031FT, 031FTR, 031FTRL, 031TP, 070BM, 070FT, 070FTR, 0712VA, 071BM, 071FT, 071FTR, 071FTRL, 071TP, 090BM, 090FT, 090FTR, 091BM, 091FT, 091FTR, 091FTRL, 091TP, 092VA, 092VAGG, 30CPS, 30F, 30FS, 31, 31PD6, 31PI6, 31R, 31TC, 31TP, 32, 32TC, 32TP, 32TPV, 32V, 60SM, 70CP, 70F, 712D, 712VA, 71CP, 71CP2, 71D, 71DGG, 71F, 71PD10...(Otros modelos se puede ver en la tienda web)		



			
1			
código	100012	referencia	32T0150
descripción	encendedor piezoeléctrico cuerpo plástico soplado montaje ø 18mm empalme ø2,4mm		
Para modelos:	031FT04, 031FT06, 070FT04, 070FT05, 071FT04, 071FT06, 090FT04, 090FT05, 091FT04, 091FT06, 0A0BMG, 0A0FT1G, 0A0FT2G, 0A0FT4G, 0A0FT5G, 0A0GRG, 0A1CP1G, 0B0FT1G, 0B0FT2G, 0B0FT4G, 0B0FT5G, 0B1CP1G, 0D0BMG, 0D0FT1G, 0D0FT2G, 0D0FT4G, 0D0FT5G, 0D0GRG, 0D1CP1G, 0G0FT1G, 0G0FT2G, 0G0FT4G, 0G0FT5G, 0G1CP1G, 0M0FA1, 0M0FR1G, 0M0FT1G, 0M0FT2G, 0M0FT4G, 0M0FT5G, 0M0GL1G, 0M0GL2G, 1A0BMG, 1A0FA2, 1A0FA5, 1A0FAS2, 1A0FT1G, 1A0FT2G, 1A0FT3G, 1A0FT4G...(Otros modelos se puede ver en la tienda web)		
repuestos para	100012		
	código	referencia	37Q2100
	 tapa para piezoencendedor		

			
1			
código	100009	referencia	3005580 3166990
descripción	encendedor piezoeléctrico cuerpo plástico soplado montaje ø 18mm empalme ø2,4mm dimensiones frontales 26mm M18x1,5		
Para modelos:	031FT04, 031FT06, 070FT04, 070FT05, 071FT04, 071FT06, 090FT04, 090FT05, 091FT04, 091FT06, 0A0BMG, 0A0FAVA, 0A0FT1G, 0A0FT2G, 0A0FT4G, 0A0FT5G, 0A0GRG, 0A1CP1G, 0B0FT1G, 0B0FT2G, 0B0FT4G, 0B0FT5G, 0B1CP1G, 0D0BMG, 0D0FAVA, 0D0FT1G, 0D0FT2G, 0D0FT4G, 0D0FT5G, 0D0GRG, 0D1CP1G, 0G0FR5G, 0G0FT1G, 0G0FT1G-VERS.032008, 0G0FT2G, 0G0FT2G-VERS.032008, 0G0FT4G, 0G0FT4G-VERS.032008, 0G0FT5G, 0G0FT5G-VERS.032008, 0G0FT7G, 0G1BR3G, 0G1CP1G, 0G1CP1G-VERS.2004, 0G1FR7G, 0M0FA1, 0M0FR1G, 0M0FT1G, 0M0FT2G, 0M0FT4G...(Otros modelos se puede ver en la tienda web)		
accesorios para	100009		
	código	referencia	37Q2100
	 tapa para piezoencendedor		
	código	referencia	—
	 tapa para piezoencendedor int.ø 22mm ø ext. 35mm H 25mm		
	código	referencia	—
	 tapa para piezoencendedor int.ø 21mm ø ext. 36mm		

accesorios

			
1			
código	101730	referencia	3191100
descripción	arandela int.ø 18mm ø ext. 31mm H 2mm		
Para modelos:	0A0BMG, 0A0FAVA, 0A0FT1G, 0A0FT2G, 0A0FT4G, 0A0FT5G, 0A0GRG, 0A1CP1G, 0B0FT1G, 0B0FT2G, 0B0FT4G, 0B0FT5G, 0B1CP1G, 0D0BMG, 0D0FAVA, 0D0FT1G, 0D0FT2G, 0D0FT4G, 0D0FT5G, 0D0GRG, 0D1CP1G, 0G0FR5G, 0G0FT1G, 0G0FT2G, 0G0FT4G, 0G0FT5G, 0G1BR3G, 0G1CP1G, 0G1CP1G-VERS.2004, 0G1FR7G, 1A0BMG, 1A0FA2, 1A0FA5, 1A0FAB, 1A0FAS2, 1A0FT1G, 1A0FT2G, 1A0FT3G, 1A0FT4G, 1A0FT6G, 1A0GRG, 1A0TP0, 1A1CP1G, 1A1CP2G, 1A1FA1G, 1A1FA2G, 1A1FA4G, 1A1FA5G, 1A1FAAG, 1A1FABG...(Otros modelos se puede ver en la tienda web)		

			
1			
código	101339	referencia	37Q2100
descripción	tapa para piezoencendedor		
Para modelos:	0A0BMG, 0A0FAVA, 0A0FT1G, 0A0FT2G, 0A0FT4G, 0A0FT5G, 0A0GRG, 0A1CP1G, 0B0FT1G, 0B0FT2G, 0B0FT4G, 0B0FT5G, 0B1CP1G, 0D0BMG, 0D0FAVA, 0D0FT1G, 0D0FT2G, 0D0FT4G, 0D0FT5G, 0D0GRG, 0D1CP1G, 0G0FR5G, 0G0FT1G, 0G0FT1G-VERS.032008, 0G0FT2G, 0G0FT2G-VERS.032008, 0G0FT4G, 0G0FT4G-VERS.032008, 0G0FT5G, 0G0FT5G-VERS.032008, 0G0FT7G, 0G1BR3G, 0G1CP1G, 0G1CP1G-VERS.2004, 0G1FR7G, 191BR2EA, 1A0BMG, 1A0FA2, 1A0FA5, 1A0FAB, 1A0FAS2, 1A0FT1G, 1A0FT2G, 1A0FT3G, 1A0FT4G, 1A0FT6G, 1A0GRG, 1A0TP0, 1A1BR1E, 1A1BR2E...(Otros modelos se puede ver en la tienda web)		

unidades de encendido

			
1			
código	102485	referencia	32T0040 32T0041 32T0050 32T0210
descripción	grupo de encendido salidas 2 220-240VAC 0.6VA 50-60Hz		
Para modelos:	04WFAAV, 06WCP1GM, 06WFR3GD, 08WCP1GM, 08WFT1GV, 08WFT2GV, 08WFT3GV, 08WFT4GV, 08WFT6GV, 08WFT7GV, 08WGRGV, 090BM1G, 090FAA, 090FAVA, 090FT1G, 090FT2G, 090FT4G, 090FT5G, 090FT7G, 090GRG, 091CP1G, 091FR1G, 091FR1GD, 091FR3G, 091FR3GD, 0A1FR1G, 0A1FR1GD, 0A1FR1GD-VERS.2004, 0A1FR1G-VERS.2004, 0A1FR3G, 0A1FR3GD, 0B1FR1G, 0B1FR1GD, 0D1FR1G, 0D1FR1GD, 0D1FR1GD-VERS.2004, 0D1FR1G-VERS.2004, 0D1FR3G, 0D1FR3GD, 0G1FR3G, 0G1FR3GD, 10CP1GA, 10WFR4GD, 10WTPGV, 12CP1GA, 12WFA6G, 18CP2GA, 190BM2G, 190FAB, 190FT15G...(Otros modelos se puede ver en la tienda web)		

			
1			
código	103334	referencia	3144130
descripción	grupo de encendido salidas 2 220-240VAC medidas 83x42x32mm distancia de sujeción 34mm entrada F2,8 salida F2,8 tipo TSM 17VA 50/60Hz		
Para modelos:	BX101G, BX101G-VERS.122013, BX122G, BX122G-VERS.122013, BX61G, BX61G-VERS.122013, BX82G, BX82G-VERS.122013, FX101G1, FX101G1R, FX101G2, FX101G2C, FX101G2C-VERS.032014, FX101G2R, FX101G2R-VERS.032014, FX101G2-VERS.032014, FX101G3, FX101G3C, FX101G3C-VERS.022014, FX101G3R, FX101G3R-VERS.022014, FX101G3-VERS.022014, FX10G2CR, FX10G2CR-VERS.032014, FX10G3CR, FX10G3CR-VERS.022014, FX122G1, FX122G2, FX122G2C, FX122G2T, FX122G2T-VERS.032014, FX122G3, FX122G3C, FX122G3T, FX122G3T-VERS.022014, FX12G3CT, FX12G3CT-VERS.022014, FX201G2, FX201G2P, FX201G2P-VERS.032014, FX201G2-VERS.032014, FX201G3P, FX201G3-VERS.022014, FX202G2, FX202G2-VERS.032014, FX202G3, FX202G3-VERS.022014, FX61G1, FX61G1R, FX61G2...(Otros modelos se puede ver en la tienda web)		

			
1			
código	101004	referencia	32T0070
descripción	grupo de encendido salidas 6 230VAC entrada F6,3x0,8 salida F2,8x0,8 50Hz montaje ø 88mm		

			
1			
código	102389	referencia	3015000
descripción	grupo de encendido salidas 6 230VAC medidas 135x23x34mm distancia de sujeción 123mm entrada F6,3x0,8 salida F2,8x0,8 0.6VA 50/60Hz		
Para modelos:	08WFA4E, 08WFA4G, 08WFAAE, 08WFAAG, 08WFAAV, 10WTPGE, 12WFA6E, 12WFA6G, 12WFAAA, 12WFAAE, 12WFAAG, 12WFAAN		

			
2			
código	101002	referencia	3107650
descripción	grupo de encendido salidas 2 230VAC medidas 88x23x34mm distancia de sujeción 73mm entrada F6,3x0,8 salida F2,8x0,8 0.6VA 50/60Hz		
Para modelos:	091FR1ID-VERS.052012, 091FR1I-VERS.032012, 091FR7G, 091FR7GS, 091FR7G-VERS.052012, 091FR7GX, 10CP1IA, 12CP1IA, 18CP2IA, 191FR2ID-VERS.092012, 191FR2I-VERS.032012		

			
1			
código	101005	referencia	32T0020
descripción	grupo de encendido salidas 8 230VAC medidas 92x68x33mm distancia de sujeción 88mm entrada F6,3x0,8 salida F2,8x0,8 tipo BK 40086-00 0.6VA 50-60Hz		

			
1			
código	107548	referencia	3134640
descripción	grupo de encendido salidas 4 220VAC medidas 110x22x40mm distancia de sujeción 100mm entrada F6,3x0,8 salida F2,8x0,8 50-60Hz		
Para modelos:	091FR1I, 091FR1IA, 091FR1ID, 190FAA, 191FR2I, 191FR2ID		

termopares

termopares insertables

termopares insertables estándar

con casquillo de enchufe ø6mm

tipo Junkers con punta aluminizada

			
1			
código	102388	referencia	32T0030
descripción	grupo de encendido salidas 4 230VAC medidas 111x23x34mm distancia de sujeción 100mm entrada F6,3x0,8 salida F2,8x0,8 tipo WAC-T4 0.6VA 50/60Hz		

			
1			
código	102229	referencia	33A0360
descripción	termopar M10x1 L 1000mm clavija ø6,0mm		



con casquillo de enchufe $\varnothing 6,5$ mm

termopares SIT

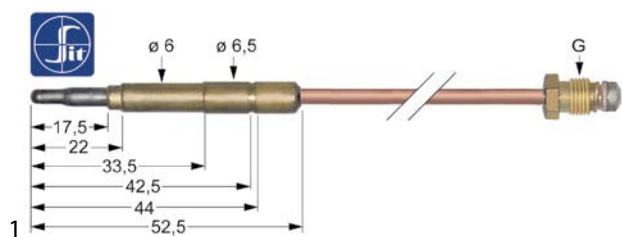

código	107621	referencia	33A0370
descripción	termopar SIT M10x1 L 1500mm conexión para conector $\varnothing 6,0(6,5)$ mm		

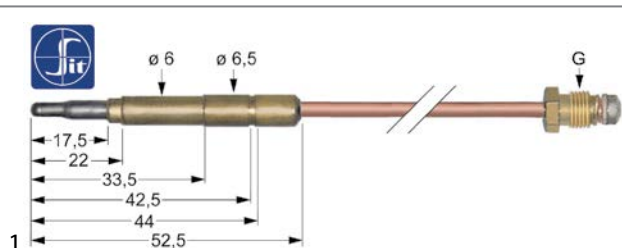

código	107605	referencia	33A0520 33A0890
descripción	termopar SIT M8x1 L 1500mm conexión para conector $\varnothing 6,0(6,5)$ mm		
Para modelos:	071TP, 091TP, 1G1PD1G, 30CPs, 31, 31PD6, 31TC, 31TP, 32, 32TC, 32TP, 32TPV, 32V, 70CP, 71CP, 71CP2, 71PD10, 71PD15, 71TP, 72TP, 72TPGG, 90CP, 91CP		

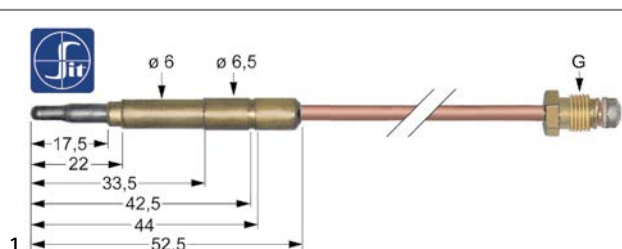

código	107600	referencia	33A0390
descripción	termopar SIT M8x1 L 320mm conexión para conector $\varnothing 6,0(6,5)$ mm		

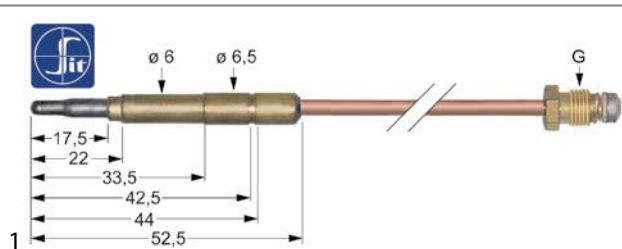

código	107601	referencia	33A0400 33A1060
descripción	termopar SIT M8x1 L 600mm conexión para conector $\varnothing 6,0(6,5)$ mm		
Para modelos:	030, 030FT, 030FTR, 031, 031FT, 031FTR, 031FTRL, 031TP, 032, 070D, 070DGG, 070FT, 070FTR, 0712D, 0712VA, 071D, 071DGG, 071FT, 071FTR, 071FTRL, 072D, 072DGG, 090, 090FT, 090FTR, 090GG, 091, 091FT, 091FTR, 091FTRL, 091GG, 092, 092GG, 092VA, 092VAGG, 0A0FAS, 0B0FAS, 0D0FAS, 1A0FA2, 1A0FAS, 1A0FAB, 1A0FAS, 1A0FAS2, 1A1FA2G, 1A1FA5G, 1A1FABG, 1A1FAS2G, 1A1FASG, 1B0FAS, 1B0FAS2...(Otros modelos se puede ver en la tienda web)		

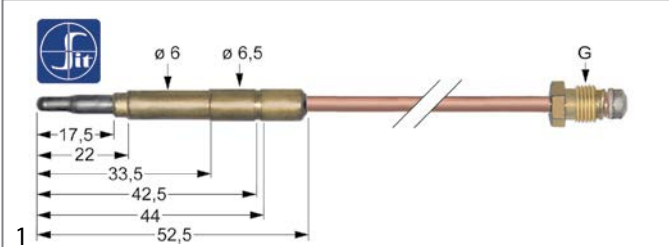

código	107612	referencia	32A0310
descripción	termopar SIT M9x1 L 1000mm conexión para conector $\varnothing 6,0(6,5)$ mm		

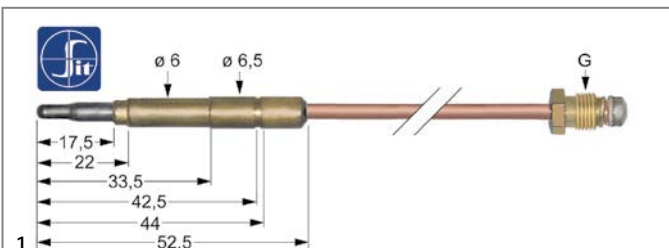

código	107614	referencia	33A0320
descripción	termopar SIT M9x1 L 1500mm conexión para conector $\varnothing 6,0(6,5)$ mm		
Para modelos:	08WFA4G, 08WFAAG, 10WTPGE, 10WTPGV, 12WFA6G, 12WFAAG, 191FAAG, 191FABG, 191FADG, 191TPG, 1A1BR1G, 1A1BR1GA, 1A1BR2G, 1A1BR2GA, 1A1FA1G, 1A1FA2G, 1A1FA4G, 1A1FA5G, 1A1FAAG, 1A1FABG, 1A1TP0G-VERS.2002, 1B1FAS2G, 1B1FASG, 1D1BR1G, 1D1BR1GA, 1D1BR2G, 1D1BR2GA, 1D1FA1G, 1D1FA2G, 1D1FA4G, 1D1FA5G, 1D1FAAG, 1D1FABG, 1D1TP0G-VERS.2002, 1G1FA0G, 1G1FA0GV, 1G1FABG, 1G1FAPG, 1G1TP0G, 291FAG, 291TPCG, 2A1BR1G, 2A1BR1GA, 2A1BR2G, 2A1BR2GA, 2A1FA1G, 2A1FA4G, 2A1FAAG, 2A1TP3G, 2A1TP6G...(Otros modelos se puede ver en la tienda web)		

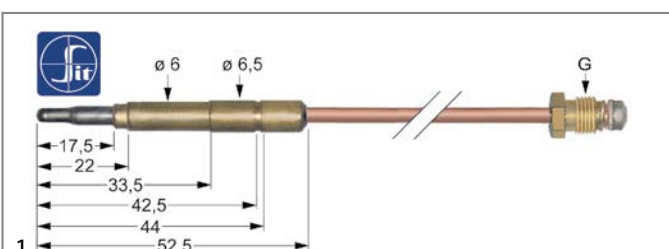

código	107609	referencia	33A0310 33A0340
descripción	termopar SIT M9x1 L 600mm conexión para conector $\varnothing 6,0(6,5)$ mm		
Para modelos:	GR4A-0NR01, SM1L, SM1LA, SM1LAW, SM1LW, SM2L, SM2LR, SM2LW, SM2S, SM2SR, SM2SW, SM3S, SM3SR		

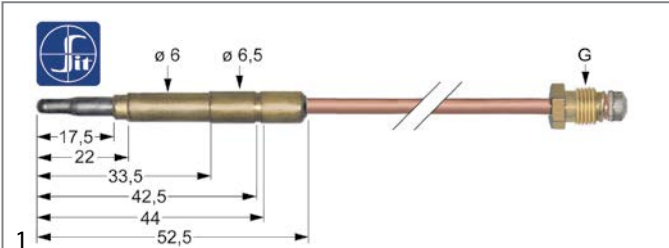

código	107611	referencia	33A1140 33A1190
descripción	termopar SIT M9x1 L 850mm conexión para conector $\varnothing 6,0(6,5)$ mm		
Para modelos:	06WCP1GM, 070BM, 071BM, 08WCP1GM, 08WFT1GV, 08WFT2GV, 08WFT3GV, 08WFT7GV, 090BM, 091BM, 10WTPGE, 10WTPGV, 191BR1G, 191BR1GA, 191BR2G, 191BR2GA, 1A1FAS2G, 1A1FASG, 1A1PD1G, 1A1PD2G, 1A1PI1G, 1A1PI1GA, 1A1TP0G, 1D1FAS2G, 1D1FASG, 1D1PD1G, 1D1PD2G, 1D1PI1G, 1D1PI1GA, 1D1TP0G, 1G1BR1G, 291BR1G, 291BR1GA, 291BR2G, 291BR2GA, 2A1FAS2G, 2A1FASG, 2A1TPSG, 2D1FAS2G, 2D1FASG, 2D1TPSG, 31R, 3A1FASG, 3D1FASG, 6040560, 6042490, 6042500, 6043200, 712D, 712VA...(Otros modelos se puede ver en la tienda web)		

termopares roscados otros

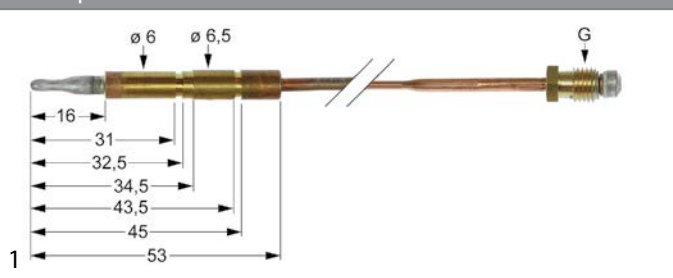

código	102998	referencia	33A0680
descripción	termopar M8x1 L 600mm clavija ø6,0mm		
Para modelos:	030, 030FT, 030FTR, 031, 031FT, 031FTR, 031FTRL, 031TP, 032, 04WFAAV, 070D, 070DGG, 070FT, 070FTR, 0712D, 0712VA, 071D, 071DGG, 071FT, 071FTR, 071FTRL, 072D, 072DGG, 08WFA4E, 08WFA4G, 08WFAAE, 08WFAAG, 08WFAAV, 08WGRGV, 090, 090FAA, 090FAVA, 090FT, 090FT1G, 090FT2G, 090FT7G, 090FTR, 090GG, 090GRG, 091, 091CP1G, 091FT, 091FTR, 091FTRL, 091GG, 092, 092GG, 092VA, 092VAGG, 0A0FA1...(Otros modelos se puede ver en la tienda web)		

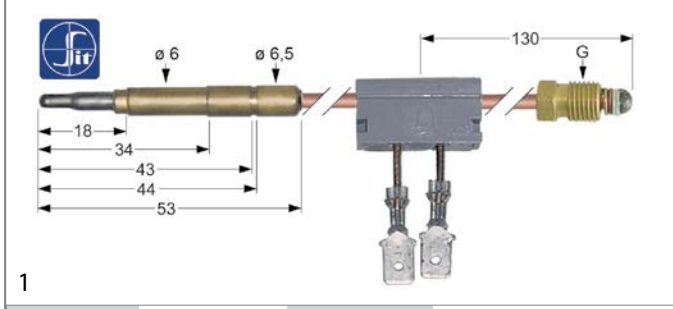

código	107177	referencia	33A0140
descripción	termopar SIT con interruptor M9x1 L 600mm clavija ø6,0mm F 6,3mm		
Para modelos:	031FT04, 031FT06, 070FT04, 070FT05, 071FT04, 071FT06, 08WFT-4GV, 08WFT6GV, 090BM1G, 090FT04, 090FT05, 090FT4G, 090FT5G, 091FR3G, 091FR3GD, 091FT04, 091FT06, 0A0BMG, 0A0FT1G, 0A0FT2G, 0A0FT4G, 0A0FT5G, 0A1FR1G, 0A1FR1GD, 0A1FR1GD-VERS.2004, 0A1FR1G-VERS.2004, 0A1FR3G, 0A1FR3GD, 0B0FT1G, 0B0FT2G, 0B0FT4G, 0B0FT5G, 0B1FR1G, 0B1FR1GD, 0D0BMG, 0D0FT1G, 0D0FT2G, 0D0FT4G, 0D0FT5G, 0D1FR1G, 0D1FR1GD, 0D1FR1GD-VERS.2004, 0D1FR1G-VERS.2004, 0D1FR3G, 0D1FR3GD, 0G0FR5G, 0G0FT4G, 0G0FT5G, 0G1BR3G, 0G1FR3G...(Otros modelos se puede ver en la tienda web)		

termopares insertables con interrupción

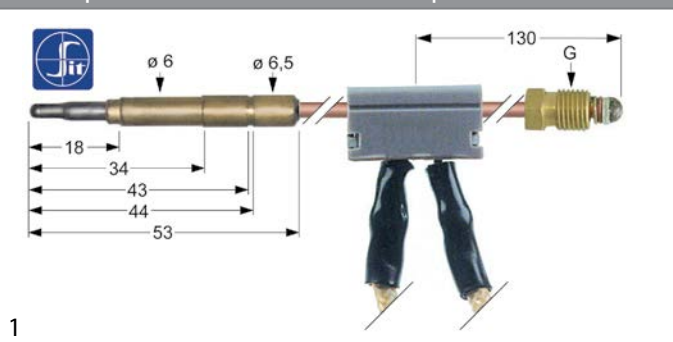

código	107863	referencia	6021770
descripción	termopar SIT con interruptor M9x1 L 1000mm conexión para conector ø6,0(6,5)mm		
Para modelos:	06WCP1GM, 06WFR3GD, 091CP1G, 091FR1G, 091FR1GD, 0G0FR5G, 0G1CP1G-VERS.2004, 0M0FR1G, 0M0FT4G, 0M0FT5G, 10CP1GA, 10WFR4GD, 12CP1GA, 18CP2GA, 191CP1G, 191CP2G, 191FR2G, 191FR2GD, 191PI1G, 191PI1GA, 191PI2G, 191PI2GA, 1A1FR2G, 1A1FR2GD, 1A1FR2GD-VERS.2004, 1A1FR2G-VERS.2004, 1A1FR4G, 1A1FR4GD, 1A1PI1G, 1A1PI1GA, 1D1FR2G, 1D1FR2GD, 1D1FR2GD-VERS.2004, 1D1FR2G-VERS.2004, 1D1FR4G, 1D1FR4GD, 1D1PI1G, 1D1PI1GA, 1G0FR6G, 1G1CP1G-VERS.2004, 1G1CP2G-VERS.2004, 1G1FR4G, 1G1FR4GD, 1G1PI1G, 1M0FR2G, 1M0FT4G, 1M0FT5G, 1M0FT6G, 291FAGF, 2M0FT4G...(Otros modelos se puede ver en la tienda web)		

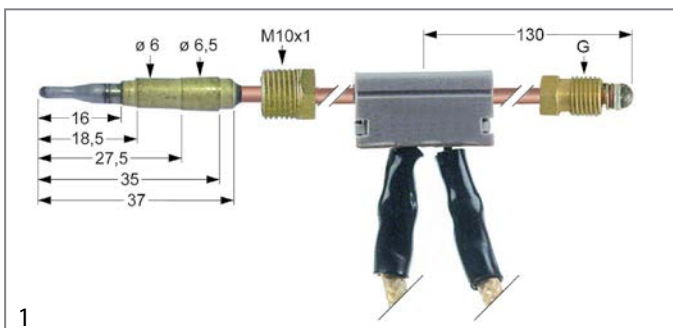

código	102252	referencia	33A1410 6021780
descripción	termopar con interruptor M9x1 L 600mm clavija ø6,0mm cable 650mm		
Para modelos:	06WFR3GD, 090BM1G, 090FT4G, 090FT5G, 091FR1G, 091FR1GD, 091FR3G, 091FR3GD, 0A0BMG, 0A1FR1G, 0A1FR1GD, 0A1FR1GD-VERS.2004, 0A1FR1G-VERS.2004, 0B1FR1G, 0B1FR1GD, 0D0BMG, 0D1FR1G, 0D1FR1GD, 0D1FR1GD-VERS.2004, 0D1FR1G-VERS.2004, 0G0FT4G, 0G0FT4G-VERS.032008, 0G0FT5G, 0G0FT5G-VERS.032008, 0G1BR3G, 0G1FR3G, 0G1FR3GD, 0G1FR7G, 10WFR4GD, 190BM2G, 190FT15G, 190FT42G, 190FT4G, 190FT6G, 191FR2G, 191FR2GD, 191FR4G, 191FR4GD, 1A0BMG, 1A1FR2G, 1A1FR2GD, 1A1FR2GD-VERS.2004, 1A1FR2G-VERS.2004, 1A1FR4G, 1A1FR4GD, 1D0BMG, 1D1FR2G, 1D1FR2GD, 1D1FR2GD-VERS.2004, 1D1FR2G-VERS.2004...(Otros modelos se puede ver en la tienda web)		

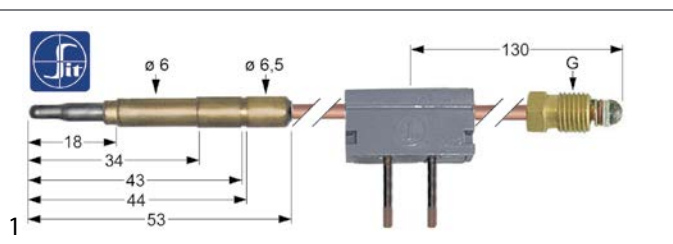

código	107164	referencia	33A0900
descripción	termopar SIT con interruptor M9x1 L 1000mm conexión para conector ø6,0(6,5)mm conexión para soldadura		
Para modelos:	0M0FR1G, 0M0FT4G, 0M0FT5G, 191PI1G, 191PI1GA, 191PI2G, 191PI-2GA, 1A1PI1G, 1A1PI1GA, 1D1PI1G, 1D1PI1GA, 1G1PI1G, 1M0FR2G, 1M0FT4G, 1M0FT5G, 1M0FT6G, 2M0FT4G, 2M0FT5G, 2M0FT6G, 30F, 30F1, 30F1B, 30FS, 30FS2, 30FS2B, 31PI6, 70F, 70F1, 70F1B, 71F, 71F2, 71F2B, 71PI10, 71PI10A, 90F110B, 91F210, 91F210B, 91F223B, 91PI10, 91PI10A, FC101, FC241, FC241G, FC61, FCV101, FCV101DM, FCV101DS, FCV141, FCV141DM, FCV141DS...(Otros modelos se puede ver en la tienda web)		

alargadores



código	102013	referencia	33A0130 33A1270
descripción	alargador para termopar rosca M9x1 L 500mm		
Para modelos:	031FT04, 031FT06, 1A1BR1G, 1A1BR1GA, 1A1BR2G, 1A1BR2GA, 1D1BR1G, 1D1BR1GA, 1D1BR2G, 1D1BR2GA, 2A1BR1G, 2A1BR1GA, 2A1BR2G, 2A1BR2GA, 2D1BR1G, 2D1BR1GA, 2D1BR2G, 2D1BR2GA		

accesorios para	102013	código	101261	referencia	—
					unión roscada para termopar rosca M9x1 UE 1 pzs



accesorios			
tornillos			
1			
código	100920	referencia	33Q2940
descripción	unión roscada para temopar rosca M8x1 / M9x1 UE 1 pzs		
Para modelos:	06WCP1GM, 08WCP1GM, 090FT1G, 090FT2G, 090FT7G, 091CP1G, 0A0FT4G, 0A0FT5G, 0B0FT1G, 0B0FT2G, 0B0FT4G, 0B0FT5G, 0D0FT4G, 0D0FT5G, 0G0FT4G, 0G0FT5G, 0G1CP1G-VERS.2004, 190FT1G, 190FT2G, 190FT3G, 190FT4G, 190FT6G, 190FT7G, 191CP1G, 191CP2G, 1A0FT4G, 1A0FT6G, 1A1PD2G, 1A1P1G, 1A1P1GA, 1B0FT4G, 1B0FT6G, 1D0FT4G, 1D0FT6G, 1D1PD2G, 1D1P1G, 1D1P1GA, 1G0FT4G, 1G0FT6G, 1G1CP1G-VERS.2004, 1G1CP2G-VERS.2004, 1G1P1G, 31P16, 71P10, 71P10A, 91P10, 91P10A, G1FAGS, G1FAGST		

1			
código	104794	referencia	34A2050 34A2051 34A2052
descripción	cabezal de quemador para ø de tapa de quemador 130mm nueva versión		
Para modelos:	0A0FA1, 0A0FA4, 0D0FA1, 0D0FA4, 1A0FA1, 1A0FA2, 1A0FA4, 1A0FA5, 1A1FA1G, 1A1FA2G, 1A1FA4G, 1A1FA5G, 1D0FA1, 1D0FA2, 1D0FA4, 1D0FA5, 1D1FA1G, 1D1FA2G, 1D1FA4G, 1D1FA5G, 2A0FA1, 2A0FA4, 2A1FA1G, 2A1FA4G, 2A1TP3G, 2A1TP6G, 2D0FA1, 2D0FA4, 2D1FA1G, 2D1FA4G, 2D1TP3G, 2D1TP6G, 3A1FA1G, 3A1FA4G, 3D1FA1G, 3D1FA4G		

otros			
1			
código	100950	referencia	35T0680
descripción	escuadra de sujeción UE 1 pzs		

1			
código	532541	referencia	3152040
descripción	junta tórica silicona espesor 1.78mm int.ø 47.35mm UE 1 pzs		
Para modelos:	04WFAAV, 08WFA4E, 08WFA4G, 08WFAAE, 08WFAAG, 08WFAAV, 090FAA, 0A0FA1, 0A0FA4, 0A0FAA, 0D0FA1, 0D0FA4, 0D0FAA, 0G0FA0, 12WFA6E, 12WFA6G, 12WFAAA, 12WFAAE, 12WFAAG, 12WFAAN, 190FA, 190FAA, 190FAB, 190FAD, 191FAAE, 191FAAG, 191FABG, 191FADG, 191FAE, 191FAG, 1A0FA1, 1A0FA2, 1A0FA4, 1A0FA5, 1A0FAA, 1A0FAB, 1A1FA1G, 1A1FA2G, 1A1FA4G, 1A1FA5G, 1A1FAAG, 1A1FABG, 1D0FA1, 1D0FA2, 1D0FA4, 1D0FA5, 1D0FAA, 1D0FAB, 1D1FA1G, 1D1FA2G...(Otros modelos se puede ver en la tienda web)		

quemadores de gas

quemadores de cocina

quemadores de cocina específicos del fabricante

ANGELO PO

serie Alpha (1), Delta (2), Gamma

1			
código	104756	referencia	34A2030 34A2032
descripción	cabezal de quemador para ø de tapa de quemador 110mm nueva versión		
Para modelos:	0A0FA1, 0A0FA4, 0D0FA1, 0G0FA0, 1A0FA1, 1A0FA2, 1A1FA1G, 1A1FA2G, 1D0FA1, 1D0FA2, 1D1FA1G, 1D1FA2G, 1G0FA0, 1G1FA0E, 1G1FA0EV, 1G1FA0G, 1G1FA0GV, 1G1FAPG, 2A0FA1, 2A1FA1G, 2A1TP3G, 2D0FA1, 2D1FA1G, 2D1TP3G, 2G0FA0, 2G1FA0G, 2G1FADG, 2G1FADGV, 2G1FAPG, 2G1TP3G, 3A1FA1G, 3D1FA1G		

1			
código	104059	referencia	3311911 34A2070 34A2071
descripción	parte inferior de quemador para ø de tapa de quemador 80/110mm		
Para modelos:	08WFA4E, 090FAA, 0A0FA1, 0A0FA4, 0D0FA1, 0D0FA4, 0G0FA0, 12WFA6E, 190FA, 190FAA, 190FAB, 190FAD, 191FAAE, 191FAAG, 191FABG, 191FADG, 191FAE, 191FAG, 1A0FA1, 1A0FA2, 1A0FA4, 1A0FA5, 1A1FA1G, 1A1FA2G, 1A1FA4G, 1A1FA5G, 1D0FA1, 1D0FA2, 1D0FA4, 1D0FA5, 1D1FA1G, 1D1FA2G, 1D1FA4G, 1D1FA5G, 1G0FA0, 1G0FA0B, 1G1FA0E, 1G1FA0EV, 1G1FA0G, 1G1FA0GV, 1G1FABG, 1G1FAPG, 290FA, 291FAG, 291FAGF, 291TPCG, 2A0FA1, 2A0FA4, 2A1FA1G, 2A1FA4G...(Otros modelos se puede ver en la tienda web)		

1			
código	104006	referencia	34A2020
descripción	portaboquillas		
Para modelos:	08WFA4E, 090FAA, 0A0FA1, 0A0FA4, 0D0FA1, 0D0FA4, 0G0FA0, 12WFA6E, 190FA, 190FAA, 190FAB, 190FAD, 191FAAE, 191FAAG, 191FABG, 191FADG, 191FAE, 191FAG, 1A0FA1, 1A0FA2, 1A0FA4, 1A0FA5, 1A1FA1G, 1A1FA2G, 1A1FA4G, 1A1FA5G, 1D0FA1, 1D0FA2, 1D0FA4, 1D0FA5, 1D1FA1G, 1D1FA2G, 1D1FA4G, 1D1FA5G, 1G0FA0, 1G0FA0B, 1G1FA0E, 1G1FA0EV, 1G1FA0G, 1G1FA0GV, 1G1FABG, 1G1FAPG, 290FA, 291FAG, 291FAGF, 291TPCG, 2A0FA1, 2A0FA4, 2A1FA1G, 2A1FA4G...(Otros modelos se puede ver en la tienda web)		



			
1			
código	104792	referencia	34A2040
descripción	tapa de quemador ø 110mm		
Para modelos:	0A0FA1, 0A0FA4, 0D0FA1, 0G0FA0, 1A0FA1, 1A0FA2, 1A1FA1G, 1A1FA2G, 1D0FA1, 1D0FA2, 1D1FA1G, 1D1FA2G, 1G0FA0, 1G1FA0E, 1G1FA0EV, 1G1FA0G, 1G1FA0GV, 1G1FAPG, 2A0FA1, 2A1FA1G, 2A1TP3G, 2D0FA1, 2D1FA1G, 2D1TP3G, 2G0FA0, 2G1FA0G, 2G1FAPG, 2G1TP3G, 3A1FA1G, 3D1FA1G, 6FA		

			
1			
código	104790	referencia	34A2060
descripción	tapa de quemador ø 130mm 7.5kW		
Para modelos:	0A0FA1, 0A0FA4, 0D0FA1, 0D0FA4, 1A0FA1, 1A0FA2, 1A0FA4, 1A0FA5, 1A1FA1G, 1A1FA2G, 1A1FA4G, 1A1FA5G, 1D0FA1, 1D0FA2, 1D0FA4, 1D0FA5, 1D1FA1G, 1D1FA2G, 1D1FA4G, 1D1FA5G, 2A0FA1, 2A0FA4, 2A1FA1G, 2A1FA4G, 2A1TP3G, 2A1TP6G, 2D0FA1, 2D0FA4, 2D1FA1G, 2D1FA4G, 2D1TP3G, 2D1TP6G, 3A1FA1G, 3A1FA4G, 3D1FA1G, 3D1FA4G		

			
1			
código	104793	referencia	34A2010
descripción	venturi ø 12mm		
Para modelos:	0A0FA1, 0A0FA4, 0D0FA1, 0G0FA0, 1A0FA1, 1A0FA2, 1A1FA1G, 1A1FA2G, 1D0FA1, 1D0FA2, 1D1FA1G, 1D1FA2G, 1G0FA0, 1G0FA0B, 1G1FA0E, 1G1FA0EV, 1G1FA0G, 1G1FA0GV, 1G1FABG, 1G1FAPG, 2A0FA1, 2A1FA1G, 2A1TP3G, 2D0FA1, 2D1FA1G, 2D1TP3G, 2G0FA0, 2G0FA0B, 2G1FA0E, 2G1FA0G, 2G1FA0GV, 2G1FABG, 2G1FACG, 2G1FADG, 2G1FADGV, 2G1FAPG, 2G1TP3G, 3A1FA1G, 3D1FA1G, 6FA		

			
1			
código	104005	referencia	34A2000
descripción	venturi ø 14.5mm		
Para modelos:	08WFA4E, 090FAA, 0A0FA1, 0A0FA4, 0D0FA1, 0D0FA4, 12WFA6E, 190FA, 190FAA, 190FAB, 190FAD, 191FAAE, 191FAAG, 191FABG, 191FADG, 191FAE, 191FAG, 1A0FA1, 1A0FA2, 1A0FA4, 1A0FA5, 1A1FA1G, 1A1FA2G, 1A1FA4G, 1A1FA5G, 1D0FA1, 1D0FA2, 1D0FA4, 1D0FA5, 1D1FA1G, 1D1FA2G, 1D1FA4G, 1D1FA5G, 290FA, 291FAG, 291FAGF, 291TPCG, 2A0FA1, 2A0FA4, 2A1FA1G, 2A1FA4G, 2A1TP3G, 2A1TP6G, 2D0FA1, 2D0FA4, 2D1FA1G, 2D1FA4G, 2D1TP3G, 2D1TP6G, 391FAG...(Otros modelos se puede ver en la tienda web)		

Serie Alpha (2), Delta (3), Omega (2)			
			
1			
código	104739	referencia	3019380
descripción	cabezal de quemador para ø de tapa de quemador 110mm 7kW		
Para modelos:	04WFAAV, 08WFA4E, 08WFA4G, 08WFAAE, 08WFAAG, 08WFAAV, 090FAA, 0A0FAA, 0D0FAA, 0G0FA0, 12WFA6E, 12WFA6G, 12WFAAA, 12WFAAE, 12WFAAG, 12WFAAN, 190FA, 190FAA, 190FAB, 190FAD, 191FAAE, 191FAAG, 191FABG, 191FADG, 191FAE, 191FAG, 1A0FAA, 1A0FAB, 1A1FAAG, 1A1FABG, 1D0FAA, 1D0FAB, 1D1FAAG, 1D1FABG, 1G0FA0, 1G0FA0B, 1G1FA0E, 1G1FA0EV, 1G1FA0G, 1G1FA0GV, 1G1FABG, 1G1FAPG, 290FA, 291FAG, 291FAGF, 291TPCG, 2A0FAA, 2A1FAAG, 2A1TPCG, 2D0FAA...(Otros modelos se puede ver en la tienda web)		
accesorios para	104739		
		código	104740
		referencia	3019390
		tapa de quemador ø 110mm 7kW	
		código	108142
		referencia	6013760 6013761 6013762
		venturi para ø de tapa de quemador 110mm apto para quemador 7kW	

			
1			
código	104097	referencia	3019360
descripción	cabezal de quemador para ø de tapa de quemador 130mm 10kW		
Para modelos:	04WFAAV, 08WFA4E, 08WFA4G, 08WFAAE, 08WFAAG, 08WFAAV, 090FAA, 0A0FAA, 0D0FAA, 12WFA6E, 12WFA6G, 12WFAAA, 12WFAAE, 12WFAAG, 12WFAAN, 190FA, 190FAA, 190FAB, 191FAAE, 191FAAG, 191FABG, 191FAE, 191FAG, 1A0FAA, 1A0FAB, 1A1FAAG, 1A1FABG, 1D0FAA, 1D0FAB, 1D1FAAG, 1D1FABG, 290FA, 291FAG, 291FAGF, 291TPCG, 2A0FAA, 2A1FAAG, 2A1TPCG, 2D0FAA, 2D1FAAG, 2D1TPCG, 391FAG, 3A1FAAG, 3D1FAAG		
accesorios para	104097		
		código	104007
		referencia	6014830 6014831 6014832
		parte inferior de quemador para ø de tapa de quemador 130mm completo con venturi y porta inyectores	



			
1			
código	104297	referencia	3057600
descripción	cabezal de quemador para ø de tapa de quemador 80mm 4kW		
Para modelos:	190FA, 190FAD, 191FADG, 191FAE, 191FAG, 1G0FA0, 1G1FA0E, 1G1FA0EV, 1G1FA0G, 1G1FA0GV, 290FA, 291FAG, 291FAGF, 2G0FA0, 2G0FA0A, 2G1FA0E, 2G1FA0G, 2G1FA0GV, 2G1FACG, 2G1FADG, 2G1FADGV, 391FAG, 6FA, 6FA1		
accesorios para	104297		
		código	104298
		referencia	3057610
		tapa de quemador ø 80mm 4kW	

Continúa en la página siguiente



accesorios para	104297		
	código	108141	referencia
			6020730 6020731
	venturi para ø de tapa de quemador 80mm apto para quemador 4kW		

	código	532541	referencia	3152040
	descripción	junta tórica silicona espesor 1.78mm int.ø 47.35mm UE 1 pzs		
Para modelos:	04WFAAV, 08WFA4E, 08WFA4G, 08WFAAE, 08WFAAG, 08WFAAV, 090FAA, 0A0FA1, 0A0FA4, 0A0FAA, 0D0FA1, 0D0FA4, 0D0FAA, 0G0FA0, 12WFA6E, 12WFA6G, 12WFAAA, 12WFAAE, 12WFAAG, 12WFAAN, 190FA, 190FAA, 190FAB, 190FAD, 191FAAE, 191FAAG, 191FABG, 191FADG, 191FAE, 191FAG, 1A0FA1, 1A0FA2, 1A0FA4, 1A0FA5, 1A0FAA, 1A0FAB, 1A1FA1G, 1A1FA2G, 1A1FA4G, 1A1FA5G, 1A1FAAG, 1A1FABG, 1D0FA1, 1D0FA2, 1D0FA4, 1D0FA5, 1D0FAA, 1D0FAB, 1D1FA1G, 1D1FA2G...(Otros modelos se puede ver en la tienda web)			



	código	104007	referencia	6014830 6014831 6014832
	descripción	parte inferior de quemador para ø de tapa de quemador 130mm completo con venturi y porta inyectores		
Para modelos:	04WFAAV, 08WFA4E, 08WFA4G, 08WFAAE, 08WFAAG, 08WFAAV, 090FAA, 0A0FAA, 0D0FAA, 12WFA6E, 12WFA6G, 12WFAAA, 12WFAAE, 12WFAAG, 12WFAAN, 190FA, 190FAA, 190FAB, 191FAAE, 191FAAG, 191FABG, 191FAE, 191FAG, 1A0FAA, 1A0FAB, 1A1FAAG, 1A1FABG, 1D0FAA, 1D0FAB, 1D1FAAG, 1D1FABG, 290FA, 291FAG, 291FAGF, 291TPCG, 2A0FAA, 2A1FAAG, 2A1TPCG, 2D0FAA, 2D1FAAG, 2D1TPCG, 391FAG, 3A1FAAG, 3D1FAAG			
accesorios para	104007			
	código	104097	referencia	3019360
	cabezal de quemador para ø de tapa de quemador 130mm 10kW			

	código	104059	referencia	3311911 34A2070 34A2071
	descripción	parte inferior de quemador para ø de tapa de quemador 80/110mm		
Para modelos:	08WFA4E, 090FAA, 0A0FA1, 0A0FA4, 0D0FA1, 0D0FA4, 0G0FA0, 12WFA6E, 190FA, 190FAA, 190FAB, 190FAD, 191FAAE, 191FAAG, 191FABG, 191FADG, 191FAE, 191FAG, 1A0FA1, 1A0FA2, 1A0FA4, 1A0FA5, 1A1FA1G, 1A1FA2G, 1A1FA4G, 1A1FA5G, 1D0FA1, 1D0FA2, 1D0FA4, 1D0FA5, 1D1FA1G, 1D1FA2G, 1D1FA4G, 1D1FA5G, 1G0FA0, 1G0FA0B, 1G1FA0E, 1G1FA0EV, 1G1FA0G, 1G1FA0GV, 1G1FABG, 1G1FAPG, 290FA, 291FAG, 291FAGF, 291TPCG, 2A0FA1, 2A0FA4, 2A1FA1G, 2A1FA4G...(Otros modelos se puede ver en la tienda web)			

	código	104006	referencia	34A2020
	descripción	portaboquillas		
Para modelos:	08WFA4E, 090FAA, 0A0FA1, 0A0FA4, 0D0FA1, 0D0FA4, 0G0FA0, 12WFA6E, 190FA, 190FAA, 190FAB, 190FAD, 191FAAE, 191FAAG, 191FABG, 191FADG, 191FAE, 191FAG, 1A0FA1, 1A0FA2, 1A0FA4, 1A0FA5, 1A1FA1G, 1A1FA2G, 1A1FA4G, 1A1FA5G, 1D0FA1, 1D0FA2, 1D0FA4, 1D0FA5, 1D1FA1G, 1D1FA2G, 1D1FA4G, 1D1FA5G, 1G0FA0, 1G0FA0B, 1G1FA0E, 1G1FA0EV, 1G1FA0G, 1G1FA0GV, 1G1FABG, 1G1FAPG, 290FA, 291FAG, 291FAGF, 291TPCG, 2A0FA1, 2A0FA4, 2A1FA1G, 2A1FA4G...(Otros modelos se puede ver en la tienda web)			

	código	104740	referencia	3019390
	descripción	tapa de quemador ø 110mm 7kW		
Para modelos:	04WFAAV, 08WFA4E, 08WFA4G, 08WFAAE, 08WFAAG, 08WFAAV, 090FAA, 0A0FAA, 0D0FAA, 0G0FA0, 12WFA6E, 12WFA6G, 12WFAAA, 12WFAAE, 12WFAAG, 12WFAAN, 190FA, 190FAA, 190FAB, 190FAD, 191FAAE, 191FAAG, 191FABG, 191FADG, 191FAE, 191FAG, 1A0FAA, 1A0FAB, 1A1FAAG, 1A1FABG, 1D0FAA, 1D0FAB, 1D1FAAG, 1D1FABG, 1G0FA0, 1G0FA0B, 1G1FA0E, 1G1FA0EV, 1G1FA0G, 1G1FA0GV, 1G1FABG, 1G1FAPG, 290FA, 291FAG, 291FAGF, 291TPCG, 2A0FAA, 2A1FAAG, 2A1TPCG, 2D0FAA...(Otros modelos se puede ver en la tienda web)			
accesorios para	104740			
	código	104739	referencia	3019380
	cabezal de quemador para ø de tapa de quemador 110mm 7kW			
	código	108142	referencia	6013760 6013761 6013762
	venturi para ø de tapa de quemador 110mm apto para quemador 7kW			

	código	104081	referencia	3019370
	descripción	tapa de quemador ø 130mm 10kW		
Para modelos:	04WFAAV, 08WFA4E, 08WFA4G, 08WFAAE, 08WFAAG, 08WFAAV, 090FAA, 0A0FAA, 0D0FAA, 12WFA6E, 12WFA6G, 12WFAAA, 12WFAAE, 12WFAAG, 12WFAAN, 190FA, 190FAA, 190FAB, 191FAAE, 191FAAG, 191FABG, 191FAE, 191FAG, 1A0FAA, 1A0FAB, 1A1FAAG, 1A1FABG, 1D0FAA, 1D0FAB, 1D1FAAG, 1D1FABG, 290FA, 291FAG, 291FAGF, 291TPCG, 2A0FAA, 2A1FAAG, 2A1TPCG, 2D0FAA, 2D1FAAG, 2D1TPCG, 391FAG, 3A1FAAG, 3D1FAAG			

	código	104298	referencia	3057610
	descripción	tapa de quemador ø 80mm 4kW		
Para modelos:	190FA, 190FAD, 191FADG, 191FAE, 191FAG, 1G0FA0, 1G1FA0E, 1G1FA0EV, 1G1FA0G, 1G1FA0GV, 290FA, 291FAG, 291FAGF, 2G0FA0, 2G0FA0A, 2G1FA0E, 2G1FA0G, 2G1FA0GV, 2G1FACG, 2G1FADG, 2G1FADGV, 391FAG, 6FA, 6FA1			
accesorios para	104298			
	código	104297	referencia	3057600
	cabezal de quemador para ø de tapa de quemador 80mm 4kW			

Continúa en la página siguiente



accesorios para	104298		
	código	108141	referencia
			6020730 6020731
	venturi para ø de tapa de quemador 80mm apto para quemador 4kW		

	1		
código	104058	referencia	3057620
descripción	venturi ø 11mm		
Para modelos:	190FA, 190FAD, 191FADG, 191FAE, 191FAG, 1G0FA0, 1G1FA0E, 1G1FA0EV, 1G1FA0G, 1G1FA0GV, 290FA, 291FAG, 291FAGF, 2G0FA0, 2G0FA0A, 2G1FA0E, 2G1FA0G, 2G1FA0GV, 2G1FACG, 2G1FADG, 2G1FADGV, 391FAG, 6FA, 6FA1		

	1		
código	104005	referencia	34A2000
descripción	venturi ø 14.5mm		
Para modelos:	08WFA4E, 090FAA, 0A0FA1, 0A0FA4, 0D0FA1, 0D0FA4, 12WFA6E, 190FA, 190FAA, 190FAB, 190FAD, 191FAAE, 191FAAG, 191FABG, 191FADG, 191FAE, 191FAG, 1A0FA1, 1A0FA2, 1A0FA4, 1A0FA5, 1A1FA1G, 1A1FA2G, 1A1FA4G, 1A1FA5G, 1D0FA1, 1D0FA2, 1D0FA4, 1D0FA5, 1D1FA1G, 1D1FA2G, 1D1FA4G, 1D1FA5G, 290FA, 291FAG, 291FAGF, 291TPCG, 2A0FA1, 2A0FA4, 2A1FA1G, 2A1FA4G, 2A1TP3G, 2A1TP6G, 2D0FA1, 2D0FA4, 2D1FA1G, 2D1FA4G, 2D1TP3G, 2D1TP6G, 391FAG...(Otros modelos se puede ver en la tienda web)		

	1		
código	108142	referencia	6013760 6013761 6013762
descripción	venturi para ø de tapa de quemador 110mm apto para quemador 7kW		
Para modelos:	04WFAAV, 08WFA4E, 08WFA4G, 08WFAAE, 08WFAAG, 08WFAAV, 090FAA, 0A0FAA, 0D0FAA, 12WFA6E, 12WFA6G, 12WFAAA, 12WFAAE, 12WFAAG, 12WFAAN, 190FA, 190FAA, 190FAB, 190FAD, 191FAAE, 191FAAG, 191FABG, 191FADG, 191FAE, 191FAG, 1A0FAA, 1A0FAB, 1A1FAAG, 1A1FABG, 1D0FAA, 1D0FAB, 1D1FAAG, 1D1FABG, 290FA, 291FAG, 291FAGF, 291TPCG, 2A0FAA, 2A1FAAG, 2A1TPCG, 2D0FAA, 2D1FAAG, 2D1TPCG, 391FAG, 3A1FAAG, 3D1FAAG		
accesorios para	108142		
	código	104739	referencia
			3019380
	cabezal de quemador para ø de tapa de quemador 110mm 7kW		
	código	104740	referencia
			3019390
	tapa de quemador ø 110mm 7kW		

	1		
código	108141	referencia	6020730 6020731
descripción	venturi para ø de tapa de quemador 80mm apto para quemador 4kW		
Para modelos:	190FA, 190FAD, 191FADG, 191FAE, 191FAG, 1G0FA0, 1G1FA0E, 1G1FA0EV, 1G1FA0G, 1G1FA0GV, 290FA, 291FAG, 291FAGF, 2G0FA0, 2G0FA0A, 2G1FA0E, 2G1FA0G, 2G1FA0GV, 2G1FACG, 2G1FADG, 2G1FADGV, 391FAG		
accesorios para	108141		
	código	104297	referencia
			3057600
	cabezal de quemador para ø de tapa de quemador 80mm 4kW		
	código	104298	referencia
			3057610
	tapa de quemador ø 80mm 4kW		

serie Combi, Junior (1ª serie), Major

	1		
código	104015	referencia	34A1110
descripción	cabezal de quemador para ø de tapa de quemador 110mm		



	1		
código	104026	referencia	34A0090
descripción	cabezal de quemador para ø de tapa de quemador 110mm		
accesorios para	104026		
	código	103014	referencia
			34A0050
	tapa de quemador ø 110mm		
	código	104018	referencia
			36D0070
	soporte de quemador para ø de tapa de quemador 60/90/110mm con portaboquillas entrada gas M20x1.5		



	1		
código	104016	referencia	34A1090 34A6760
descripción	cabezal de quemador para ø de tapa de quemador 140mm		











			
1			
código	104013	referencia	34A0570
descripción	cabezal de quemador para ø de tapa de quemador 60mm		

			
1			
código	104017	referencia	36D0060
descripción	soporte de quemador con portaboquillas entrada gas 1/4"		

			
1			
código	104024	referencia	34A0060
descripción	cabezal de quemador para ø de tapa de quemador 60mm		
accesorios para	104024		
	código	104018	referencia 36D0070
	soporte de quemador para ø de tapa de quemador 60/90/110mm con portaboquillas entrada gas M20x1.5		



			
1			
código	104019	referencia	36D1230
descripción	soporte de quemador para ø de tapa de quemador 140mm entrada gas M20x1.5		
accesorios para	104019		
	código	103016	referencia 34A1140 34A1141
	tapa de quemador ø 140mm		
	código	104016	referencia 34A1090 34A6760
	cabezal de quemador para ø de tapa de quemador 140mm		

			
1			
código	104014	referencia	34A1100
descripción	cabezal de quemador para ø de tapa de quemador 90mm		
accesorios para	104014		
	código	103013	referencia 34A0740 34A1120 34A1121 34A1123
	tapa de quemador ø 90mm		
	código	104018	referencia 36D0070
	soporte de quemador para ø de tapa de quemador 60/90/110mm con portaboquillas entrada gas M20x1.5		

			
1			
código	104018	referencia	36D0070
descripción	soporte de quemador para ø de tapa de quemador 60/90/110mm con portaboquillas entrada gas M20x1.5		
accesorios para	104018		
	código	103012	referencia 34A0040
	tapa de quemador ø 90mm		
	código	103013	referencia 34A0740 34A1120 34A1121 34A1123
	tapa de quemador ø 90mm		
	código	103014	referencia 34A0050
	tapa de quemador ø 110mm		
	código	103015	referencia 34A1130 34A1131 34A1133
	tapa de quemador ø 110mm		
	código	104014	referencia 34A1100
	cabezal de quemador para ø de tapa de quemador 90mm		
	código	104025	referencia 34A0080
	cabezal de quemador para ø de tapa de quemador 90mm		
	código	104026	referencia 34A0090
	cabezal de quemador para ø de tapa de quemador 110mm		

			
1			
código	104025	referencia	34A0080
descripción	cabezal de quemador para ø de tapa de quemador 90mm		
accesorios para	104025		
	código	103012	referencia 34A0040
	tapa de quemador ø 90mm		
	código	104018	referencia 36D0070
	soporte de quemador para ø de tapa de quemador 60/90/110mm con portaboquillas entrada gas M20x1.5		







			
1			
código	103014	referencia	34A0050
descripción	tapa de quemador ø 110mm		
accesorios para	103014		
	código	104018	referencia 36D0070
	soporte de quemador para ø de tapa de quemador 60/90/110mm con portaboquillas entrada gas M20x1.5		
	código	104026	referencia 34A0090
	cabezal de quemador para ø de tapa de quemador 110mm		



			
1			
código	103015	referencia	34A1130 34A1131 34A1133
descripción	tapa de quemador ø 110mm		
Para modelos:	030, 031, 032, 0712D, 071D, 071DGG, 072D, 072DGG, 091, 091GG, 092, 092GG, 092VA, 092VAGG, 1A0FAS, 1B0FAS, 1B1FASG, 1D0FAS, 1D1FASG, 2A0FAS2, 2A1FAS2G, 2D0FAS2, 2D1FAS2G, 2D1FASG, 31, 31GE, 31TC, 32, 32TC, 32TP, 32TPV, 32V, 3D1FASG, 712D, 71D, 71DGG, 71GE, 71GEGG, 72D, 72DGG, 72VA, 72VAGG, 72VAS, 72VASGG, 73D, 73DGG, 73VA, 73VAD, 73VADGG, 73VAGG		
accesorios para	103015		
	código	104015	referencia 34A1110
	cabezal de quemador para ø de tapa de quemador 110mm		
	código	104018	referencia 36D0070
	soporte de quemador para ø de tapa de quemador 60/90/110mm con portaboquillas entrada gas M20x1.5		



			
1			
código	103056	referencia	34A0540
descripción	tapa de quemador ø 119mm con orificio central		

			
1			
código	103016	referencia	34A1140 34A1141
descripción	tapa de quemador ø 140mm		
Para modelos:	070D, 070DGG, 0712D, 0712VA, 071D, 071DGG, 072D, 072DGG, 090, 090GG, 091, 091GG, 092, 092GG, 092VA, 092VAGG, 0A0FAS, 0B0FAS, 0D0FAS, 1A0FAS, 1A0FAS2, 1A1FAS2G, 1A1FASG, 1B0FAS, 1B0FAS2, 1B1FAS2G, 1B1FASG, 1D0FAS, 1D0FAS2, 1D1FAS2G, 1D1FASG, 2A0FAS2, 2A1FAS2G, 2A1FASG, 2A1TPSG, 2D0FAS2, 2D1FAS2G, 2D1FASG, 2D1TPSG, 3A1FASG, 3D1FASG, 712D, 712VA, 71D, 71DGG, 71GE, 71GEGG, 72D, 72DGG, 72TP...(Otros modelos se puede ver en la tienda web)		
accesorios para	103016		
	código	104016	referencia 34A1090 34A6760
	cabezal de quemador para ø de tapa de quemador 140mm		
	código	104019	referencia 36D1230
	soporte de quemador para ø de tapa de quemador 140mm entrada gas M20x1.5		

accesorios para	103016		
	código	104022	referencia 34A1401
	cabezal de quemador ø 139.5mm soporte ø 122.8mm para ø de tapa de quemador 140mm ø int. 1 92.8mm ø int. 2 85.2mm		
	código	104023	referencia 36D2771
	soporte de quemador soporte ø 35mm con portaboquillas		

			
1			
código	103010	referencia	34A0070
descripción	tapa de quemador ø 60mm		
accesorios para	103010		
	código	104017	referencia 36D0060
	soporte de quemador con portaboquillas entrada gas 1/4"		
	código	104024	referencia 34A0060
	cabezal de quemador para ø de tapa de quemador 60mm		

			
1			
código	103011	referencia	34A0750 34A1580
descripción	tapa de quemador ø 60mm		
accesorios para	103011		
	código	104013	referencia 34A0570
	cabezal de quemador para ø de tapa de quemador 60mm		
	código	104018	referencia 36D0070
	soporte de quemador para ø de tapa de quemador 60/90/110mm con portaboquillas entrada gas M20x1.5		

			
1			
código	103012	referencia	34A0040
descripción	tapa de quemador ø 90mm		
accesorios para	103012		
	código	104018	referencia 36D0070
	soporte de quemador para ø de tapa de quemador 60/90/110mm con portaboquillas entrada gas M20x1.5		
	código	104025	referencia 34A0080
	cabezal de quemador para ø de tapa de quemador 90mm		





			
1			
código	103013	referencia	34A0740 34A1120 34A1121 34A1123
descripción	tapa de quemador ø 90mm		
Para modelos:	030, 031, 032, 070D, 070DGG, 0712D, 0712VA, 071D, 071DGG, 072D, 072DGG, 090, 090GG, 091, 091GG, 092, 092GG, 092VA, 092VAGG, 0A0FAS, 0B0FAS, 0D0FAS, 1A0FAS, 1A0FAS2, 1A1FAS2G, 1A1FASG, 1B0FAS, 1B0FAS2, 1B1FAS2G, 1B1FASG, 1D0FAS, 1D0FAS2, 1D1FAS2G, 1D1FASG, 2A0FAS2, 2A1FAS2G, 2A1FASG, 2A1TPSG, 2D0FAS2, 2D1FAS2G, 2D1FASG, 2D1TPSG, 31, 31GE, 31TC, 32, 32TC, 32TP, 32TPV, 32V...(Otros modelos se puede ver en la tienda web)		
accesorios para	103013		
	código	104014	referencia 34A1100
	cabezal de quemador para ø de tapa de quemador 90mm		
	código	104018	referencia 36D0070
	soporte de quemador para ø de tapa de quemador 60/90/110mm con portaboquillas entrada gas M20x1.5		
	código	104020	referencia 34A1380
	cabezal de quemador para ø de tapa de quemador 90mm		
	código	104023	referencia 36D2771
	soporte de quemador soporte ø 35mm con portaboquillas		

			
1			
código	103055	referencia	34A0530
descripción	tapa de quemador ø 95mm con orificio central		

serie Delta, Junior (2ª serie), Omega, Senior

			
1			
código	104022	referencia	34A1401
descripción	cabezal de quemador ø 139.5mm soporte ø 122.8mm para ø de tapa de quemador 140mm ø int. 1 92.8mm ø int. 2 85.2mm		
Para modelos:	070D, 070DGG, 0712D, 0712VA, 071D, 071DGG, 072D, 072DGG, 090, 090GG, 091, 091GG, 092, 092GG, 092VA, 092VAGG, 0A0FAS, 0B0FAS, 0D0FAS, 1A0FAS, 1A0FAS2, 1A1FAS2G, 1A1FASG, 1B0FAS, 1B0FAS2, 1B1FAS2G, 1B1FASG, 1D0FAS, 1D0FAS2, 1D1FAS2G, 1D1FASG, 2A0FAS2, 2A1FAS2G, 2A1FASG, 2A1TPSG, 2D0FAS2, 2D1FAS2G, 2D1FASG, 2D1TPSG, 3A1FASG, 3D1FASG, 712D, 712VA, 71D, 71DGG, 71GE, 71GEGG, 72D, 72DGG, 72TP...(Otros modelos se puede ver en la tienda web)		
accesorios para	104022		
	código	103016	referencia 34A1140 34A1141
	tapa de quemador ø 140mm		
	código	104023	referencia 36D2771
	soporte de quemador soporte ø 35mm con portaboquillas		

			
1			
código	104021	referencia	34A1390 34A1391
descripción	cabezal de quemador para ø de tapa de quemador 110mm		
Para modelos:	030, 031, 032, 0712D, 071D, 071DGG, 072D, 072DGG, 091, 091GG, 092, 092GG, 092VA, 092VAGG, 1A0FAS, 1B0FAS, 1B1FASG, 1D0FAS, 1D1FASG, 2A0FAS2, 2A1FAS2G, 2D0FAS2, 2D1FAS2G, 2D1FASG, 31, 31GE, 31TC, 32, 32TC, 32TP, 32TPV, 32V, 3D1FASG, 712D, 71D, 71DGG, 71GE, 71GEGG, 72D, 72DGG, 72VA, 72VAGG, 72VAS, 72VASGG, 73D, 73DGG, 73VA, 73VAD, 73VADGG, 73VAGG		
accesorios para	104021		
	código	103015	referencia 34A1130 34A1131 34A1133
	tapa de quemador ø 110mm		
	código	104023	referencia 36D2771
	soporte de quemador soporte ø 35mm con portaboquillas		

			
1			
código	103053	referencia	34A1570
descripción	cabezal de quemador para ø de tapa de quemador 60mm		
accesorios para	103053		
	código	103011	referencia 34A0750 34A1580
	tapa de quemador ø 60mm		

			
1			
código	104020	referencia	34A1380
descripción	cabezal de quemador para ø de tapa de quemador 90mm		
Para modelos:	030, 031, 032, 070D, 070DGG, 0712D, 0712VA, 071D, 071DGG, 072D, 072DGG, 090, 090GG, 091, 091GG, 092, 092GG, 092VA, 092VAGG, 0A0FAS, 0B0FAS, 0D0FAS, 1A0FAS, 1A0FAS2, 1A1FAS2G, 1A1FASG, 1B0FAS, 1B0FAS2, 1B1FAS2G, 1B1FASG, 1D0FAS, 1D0FAS2, 1D1FAS2G, 1D1FASG, 2A0FAS2, 2A1FAS2G, 2A1FASG, 2A1TPSG, 2D0FAS2, 2D1FAS2G, 2D1FASG, 2D1TPSG, 31, 31GE, 31TC, 32, 32TC, 32TP, 32TPV, 32V...(Otros modelos se puede ver en la tienda web)		
accesorios para	104020		
	código	103013	referencia 34A0740 34A1120 34A1121 34A1123
	tapa de quemador ø 90mm		

Continúa en la página siguiente





accesorios para	104020			
	código	104023	referencia	36D2771
	soporte de quemador soporte ø 35mm con portaboquillas			





código	104023	referencia	36D2771
descripción	soporte de quemador soporte ø 35mm con portaboquillas		
Para modelos:	030, 031, 032, 070D, 070DGG, 0712D, 0712VA, 071D, 071DGG, 072D, 072DGG, 090, 090GG, 091, 091GG, 092, 092GG, 092VA, 092VAGG, 0A0FAS, 0B0FAS, 0D0FAS, 1A0FAS, 1A0FAS2, 1A1FAS2G, 1A1FASG, 1B0FAS, 1B0FAS2, 1B1FAS2G, 1B1FASG, 1D0FAS, 1D0FAS2, 1D1FAS2G, 1D1FASG, 2A0FAS2, 2A1FAS2G, 2A1FASG, 2A1TPSG, 2D0FAS2, 2D1FAS2G, 2D1FASG, 2D1TPSG, 31, 31GE, 31TC, 32, 32TC, 32TP, 32TPV, 32V...(Otros modelos se puede ver en la tienda web)		

accesorios para	104023			
	código	103013	referencia	34A0740 34A1120 34A1121 34A1123
	tapa de quemador ø 90mm			

	código	103015	referencia	34A1130 34A1131 34A1133
	tapa de quemador ø 110mm			

	código	103016	referencia	34A1140 34A1141
	tapa de quemador ø 140mm			

	código	104020	referencia	34A1380
	cabezal de quemador para ø de tapa de quemador 90mm			

	código	104021	referencia	34A1390 34A1391
	cabezal de quemador para ø de tapa de quemador 110mm			

	código	104022	referencia	34A1401
	cabezal de quemador ø 139.5mm soporte ø 122.8mm para ø de tapa de quemador 140mm ø int. 1 92.8mm ø int. 2 85.2mm			



código	103015	referencia	34A1130 34A1131 34A1133
descripción	tapa de quemador ø 110mm		

Para modelos:	030, 031, 032, 0712D, 071D, 071DGG, 072D, 072DGG, 091, 091GG, 092, 092GG, 092VA, 092VAGG, 1A0FAS, 1B0FAS, 1B1FASG, 1D0FAS, 1D1FASG, 2A0FAS2, 2A1FAS2G, 2D0FAS2, 2D1FAS2G, 2D1FASG, 31, 31GE, 31TC, 32, 32TC, 32TP, 32TPV, 32V, 3D1FASG, 712D, 71D, 71DGG, 71GE, 71GEGG, 72D, 72DGG, 72VA, 72VAGG, 72VAS, 72VASGG, 73D, 73DGG, 73VA, 73VAD, 73VADGG, 73VAGG		
----------------------	--	--	--

accesorios para	103015			
	código	104015	referencia	34A1110
	cabezal de quemador para ø de tapa de quemador 110mm			

	código	104018	referencia	36D0070
	soporte de quemador para ø de tapa de quemador 60/90/110mm con portaboquillas entrada gas M20x1.5			

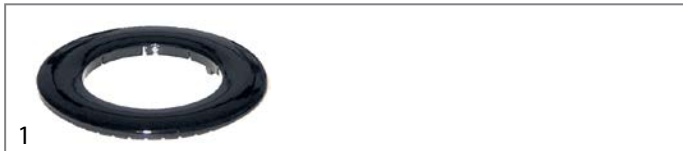



código	103016	referencia	34A1140 34A1141
descripción	tapa de quemador ø 140mm		

Para modelos:	070D, 070DGG, 0712D, 0712VA, 071D, 071DGG, 072D, 072DGG, 090, 090GG, 091, 091GG, 092, 092GG, 092VA, 092VAGG, 0A0FAS, 0B0FAS, 0D0FAS, 1A0FAS, 1A0FAS2, 1A1FAS2G, 1A1FASG, 1B0FAS, 1B0FAS2, 1B1FAS2G, 1B1FASG, 1D0FAS, 1D0FAS2, 1D1FAS2G, 1D1FASG, 2A0FAS2, 2A1FAS2G, 2A1FASG, 2A1TPSG, 2D0FAS2, 2D1FAS2G, 2D1FASG, 2D1TPSG, 3A1FASG, 3D1FASG, 712D, 712VA, 71D, 71DGG, 71GE, 71GEGG, 72D, 72DGG, 72TP...(Otros modelos se puede ver en la tienda web)		
----------------------	--	--	--

accesorios para	103016		
------------------------	--------	--	--

	código	104016	referencia	34A1090 34A6760
	cabezal de quemador para ø de tapa de quemador 140mm			

	código	104019	referencia	36D1230
	soporte de quemador para ø de tapa de quemador 140mm entrada gas M20x1.5			

	código	104022	referencia	34A1401
	cabezal de quemador ø 139.5mm soporte ø 122.8mm para ø de tapa de quemador 140mm ø int. 1 92.8mm ø int. 2 85.2mm			

	código	104023	referencia	36D2771
	soporte de quemador soporte ø 35mm con portaboquillas			



código	103011	referencia	34A0750 34A1580
descripción	tapa de quemador ø 60mm		

accesorios para	103011		
------------------------	--------	--	--

	código	104013	referencia	34A0570
	cabezal de quemador para ø de tapa de quemador 60mm			

	código	104018	referencia	36D0070
	soporte de quemador para ø de tapa de quemador 60/90/110mm con portaboquillas entrada gas M20x1.5			





código	103013	referencia	34A0740 34A1120 34A1121 34A1123
descripción	tapa de quemador ø 90mm		

Para modelos:	030, 031, 032, 070D, 070DGG, 0712D, 0712VA, 071D, 071DGG, 072D, 072DGG, 090, 090GG, 091, 091GG, 092, 092GG, 092VA, 092VAGG, 0A0FAS, 0B0FAS, 0D0FAS, 1A0FAS, 1A0FAS2, 1A1FAS2G, 1A1FASG, 1B0FAS, 1B0FAS2, 1B1FAS2G, 1B1FASG, 1D0FAS, 1D0FAS2, 1D1FAS2G, 1D1FASG, 2A0FAS2, 2A1FAS2G, 2A1FASG, 2A1TPSG, 2D0FAS2, 2D1FAS2G, 2D1FASG, 2D1TPSG, 31, 31GE, 31TC, 32, 32TC, 32TP, 32TPV, 32V...(Otros modelos se puede ver en la tienda web)		
----------------------	--	--	--

accesorios para	103013			
	código	104014	referencia	34A1100
	cabezal de quemador para ø de tapa de quemador 90mm			

Continúa en la página siguiente



accesorios para	103013			
	código	104018	referencia	36D0070
	soporte de quemador para ø de tapa de quemador 60/90/110mm con portaboquillas entrada gas M20x1.5			
	código	104020	referencia	34A1380
	cabezal de quemador para ø de tapa de quemador 90mm			
	código	104023	referencia	36D2771
	soporte de quemador soporte ø 35mm con portaboquillas			

placas radiantes

	1		
código	105333	referencia	34A0120
descripción	quemador circular ø 260mm para placa radiante		
Para modelos:	071TP, 091TP, 71TP, 72TP, 72TPGG		

parrillas de quemador

	1		
código	210100	referencia	36A0110
descripción	rejilla de quemador An 312mm L 632mm		

	1		
código	210101	referencia	36A2600
descripción	rejilla de quemador An 315mm L 315mm para 700		
Para modelos:	030, 031, 032, 31, 31GE, 31TC, 32, 32TC, 32TP, 32TPV, 32V		

	1		
código	210247	referencia	36A4970 36A4971
descripción	rejilla de quemador An 345mm L 585mm		
Para modelos:	0G0FA0, 1G0FA0, 1G0FA0B, 1G1FA0E, 1G1FA0EV, 1G1FA0G, 1G1FA0GV, 1G1FABG, 1G1FAPG, 2G0FA0, 2G0FA0A, 2G0FA0B, 2G1FA0E, 2G1FA0G, 2G1FA0GV, 2G1FABG, 2G1FACG, 2G1FADG, 2G1FADGV, 2G1FAPG, 2G1TP3G		

	1		
código	210261	referencia	36A2001 36A2002 6029680
descripción	rejilla de quemador An 365mm L 395mm H 75mm		
Para modelos:	04WFAAV, 08WFA4E, 08WFA4G, 08WFAAE, 08WFAAG, 08WFAAV, 090FAA, 0A0FA1, 0A0FA4, 0A0FAA, 0D0FA1, 0D0FA4, 0D0FAA, 12WFA6E, 12WFA6G, 12WFAAA, 12WFAAE, 12WFAAG, 12WFAAN, 190FA, 190FAA, 190FAB, 190FAD, 191FAAE, 191FAAG, 191FABG, 191FADG, 191FAE, 191FAG, 1A0FA1, 1A0FA2, 1A0FA4, 1A0FA5, 1A0FAA, 1A0FAB, 1A1FA1G, 1A1FA2G, 1A1FA4G, 1A1FA5G, 1A1FAAG, 1A1FABG, 1D0FA1, 1D0FA2, 1D0FA4, 1D0FA5, 1D0FAA, 1D0FAB, 1D1FA1G, 1D1FA2G, 1D1FA4G...(Otros modelos se puede ver en la tienda web)		

	1		
código	210179	referencia	36A2610
descripción	rejilla de quemador An 370mm L 370mm		
Para modelos:	070DGG, 0712D, 0712VA, 071DGG, 072DGG, 090GG, 091GG, 092GG, 092VAGG, 0A0FAS, 0B0FAS, 0D0FAS, 1A0FAS, 1A0FAS2, 1A1FAS2G, 1A1FASG, 1B0FAS, 1B0FAS2, 1B1FAS2G, 1B1FASG, 1D0FAS, 1D0FAS2, 1D1FAS2G, 1D1FASG, 2A0FAS2, 2A1FAS2G, 2A1FASG, 2A1TPSG, 2D0FAS2, 2D1FAS2G, 2D1FASG, 2D1TPSG, 3A1FASG, 3D1FASG, 712D, 712VA, 71DGG, 71GEGG, 72DGG, 72TPGG, 72VAGG, 72VASGG, 73DGG, 73VADGG, 73VAGG		

estrellas reductoras

	1		
código	210005	referencia	3012090 36A0491
descripción	estrella reductora L 205mm An 205mm acero cromado apto para ANGELO PO		

	1		
código	210006	referencia	36A2160 36A5450
descripción	estrella reductora L 385mm An 190mm UE 2 pzs		

placas radiantes



código	103152	referencia	36A0350
descripción	tapa de quemador ø 125mm hierro fundido		
Para modelos:	0712VA, 090FAVA, 092VA, 092VAGG, 0A0FAVA, 0D0FAVA, 190FAB, 191FABG, 1A0FA2, 1A0FA5, 1A0FAB, 1A0FAS2, 1A1FA2G, 1A1FA5G, 1A1FABG, 1A1FAS2G, 1B0FAS2, 1B1FAS2G, 1D0FA2, 1D0FA5, 1D0FAB, 1D0FAS2, 1D1FA2G, 1D1FA5G, 1D1FABG, 1D1FAS2G, 2A0FAS2, 2A1FAS2G, 2D0FAS2, 2D1FAS2G, 712VA, 72VA, 72VAGG, 72VAS, 72VASSG, 73VA, 73VAD, 73VADGG, 73VAGG		

otros



código	104324	referencia	31V0240 31V0241
descripción	pasador ø 7.4mm L 22mm EC 8 rosca M5		
Para modelos:	04WFAAV, 08WFA4E, 08WFA4G, 08WFAAE, 08WFAAG, 08WFAAV, 090FAA, 0A0FA1, 0A0FA4, 0A0FAA, 0D0FA1, 0D0FA4, 0D0FAA, 0G0FA0, 12WFA6E, 12WFA6G, 12WFAAA, 12WFAAE, 12WFAAG, 12WFAAN, 190FA, 190FAA, 190FAB, 190FAD, 191FAAE, 191FAAG, 191FABG, 191FADG, 191FAE, 191FAG, 1A0FA1, 1A0FA2, 1A0FA4, 1A0FA5, 1A0FAA, 1A0FAB, 1A1FA1G, 1A1FA2G, 1A1FA4G, 1A1FA5G, 1A1FAAG, 1A1FABG, 1D0FA1, 1D0FA2, 1D0FA4, 1D0FA5, 1D0FAA, 1D0FAB, 1D1FA1G, 1D1FA2G...(Otros modelos se puede ver en la tienda web)		

accesorios

estrellas reductoras



código	210005	referencia	3012090 36A0491
descripción	estrella reductora L 205mm An 205mm acero cromado apto para ANGELO PO		



código	210006	referencia	36A2160 36A5450
descripción	estrella reductora L 385mm An 190mm UE 2 pzs		

parrillas de quemador



código	210100	referencia	36A0110
descripción	rejilla de quemador An 312mm L 632mm		



código	210101	referencia	36A2600
descripción	rejilla de quemador An 315mm L 315mm para 700		
Para modelos:	030, 031, 032, 31, 31GE, 31TC, 32, 32TC, 32TP, 32TPV, 32V		



código	210247	referencia	36A4970 36A4971
descripción	rejilla de quemador An 345mm L 585mm		
Para modelos:	0G0FA0, 1G0FA0, 1G0FA0B, 1G1FA0E, 1G1FA0EV, 1G1FA0G, 1G1FA0GV, 1G1FABG, 1G1FAPG, 2G0FA0, 2G0FA0A, 2G0FA0B, 2G1FA0E, 2G1FA0G, 2G1FA0GV, 2G1FABG, 2G1FACG, 2G1FADG, 2G1FADGV, 2G1FAPG, 2G1TP3G		



código	210261	referencia	36A2001 36A2002 6029680
descripción	rejilla de quemador An 365mm L 395mm H 75mm		
Para modelos:	04WFAAV, 08WFA4E, 08WFA4G, 08WFAAE, 08WFAAG, 08WFAAV, 090FAA, 0A0FA1, 0A0FA4, 0A0FAA, 0D0FA1, 0D0FA4, 0D0FAA, 12WFA6E, 12WFA6G, 12WFAAA, 12WFAAE, 12WFAAG, 12WFAAN, 190FA, 190FAA, 190FAB, 190FAD, 191FAAE, 191FAAG, 191FABG, 191FADG, 191FAE, 191FAG, 1A0FA1, 1A0FA2, 1A0FA4, 1A0FA5, 1A0FAA, 1A0FAB, 1A1FA1G, 1A1FA2G, 1A1FA4G, 1A1FA5G, 1A1FAAG, 1A1FABG, 1D0FA1, 1D0FA2, 1D0FA4, 1D0FA5, 1D0FAA, 1D0FAB, 1D1FA1G, 1D1FA2G, 1D1FA4G...(Otros modelos se puede ver en la tienda web)		



1			
código	210179	referencia	36A2610
descripción	rejilla de quemador An 370mm L 370mm		
Para modelos:	070DGG, 0712D, 0712VA, 071DGG, 072DGG, 090GG, 091GG, 092GG, 092VAGG, 0A0FAS, 0B0FAS, 0D0FAS, 1A0FAS, 1A0FAS2, 1A1FAS2G, 1A1FASG, 1B0FAS, 1B0FAS2, 1B1FAS2G, 1B1FASG, 1D0FAS, 1D0FAS2, 1D1FAS2G, 1D1FASG, 2A0FAS2, 2A1FAS2G, 2A1FASG, 2A1TPSG, 2D0FAS2, 2D1FAS2G, 2D1FASG, 2D1TPSG, 3A1FASG, 3D1FASG, 712D, 712VA, 71DGG, 71GEGG, 72DGG, 72TPGG, 72VAGG, 72VASG, 73DGG, 73VADGG, 73VAGG		

mezcladores de aire			
1			
código	102200	referencia	36C1210
descripción	tubo de mezcla de aire L 27mm D1 ø 24mm D2 ø 20mm int.ø 15mm espesor 2.6mm		
Para modelos:	0A0GRG, 0D0GRG, 1A0GRG, 1D0GRG		

quemadores tubulares

quemadores tubulares			
1			
código	211057	referencia	3193150 36A5540
descripción	parrilla de piedra volcánica L 419mm An 282mm H 23.2mm apto para ANGELO PO		
Para modelos:	1G0GRG		

1			
código	211000	referencia	36A4230 36A5290
descripción	parrilla de piedra volcánica L 600mm An 330mm H 22mm		
Para modelos:	0A0GRG, 0D0GRG, 1A0GRG, 1D0GRG		
accesorios para	211000		
código	693000	referencia	35Y2780
descripción	resorte para parrilla de piedra volcánica		

1			
código	105370	referencia	34A1430 34A1431
descripción	quemador ømm sartén basculante		
Para modelos:	1A1BR1G, 1A1BR1GA, 1A1BR2G, 1A1BR2GA, 1D1BR1G, 1D1BR1GA, 1D1BR2G, 1D1BR2GA		

1			
código	105371	referencia	34A1890 34A1891
descripción	quemador ømm sartén basculante		
Para modelos:	2A1BR1G, 2A1BR1GA, 2A1BR2G, 2A1BR2GA, 2D1BR1G, 2D1BR1GA, 2D1BR2G, 2D1BR2GA		

1			
código	104760	referencia	34A2520 34A2521
descripción	quemador tubular 2 filas L 370mm An 200mm ømm H 45mm 6kW grill de piedra volcánica		
Para modelos:	1G0GRG		

1			
código	105345	referencia	34A0350
descripción	quemador tubular 2 filas L 525mm An 167mm ømm H 50mm coccedora de pasta		
Para modelos:	0A1CP1G, 0B1CP1G, 0D1CP1G, 191CP1G, 1A1CP1G, 1A1CP2G, 1D1CP1G, 1D1CP2G		

1			
código	105373	referencia	34A2080 34A2081 34A2082
descripción	quemador tubular 2 filas L 560mm An 220mm ømm 9kW grill de piedra volcánica		
Para modelos:	08WGRGV, 090GRG, 0A0GRG, 0D0GRG, 190GRG, 1A0GRG, 1D0GRG, 6042120-08WGRGV		



código	104163	referencia	34A0580
descripción	quemador tubular 2 filas L 600mm An 300mm ømm plancha grill		
Para modelos:	071FT, 071FTR, 071FTRL, 091FT, 091FTR, 091FTRL		



código	105369	referencia	34A0730
descripción	quemador tubular 6 filas L 445mm An 620mm ømm sartén basculante		
Para modelos:	71RA, 91RA		



código	105339	referencia	34A0110
descripción	quemador tubular 3 filas L 460mm An 280mm ømm H 90mm plancha grill		
Para modelos:	031FT04, 031FT06, 08WFT1GV, 08WFT2GV, 08WFT3GV, 08WFT4GV, 08WFT6GV, 08WFT7GV, 0G0FT1G, 0G0FT1G-VERS.032008, 0G0FT2G, 0G0FT2G-VERS.032008, 0G0FT4G, 0G0FT4G-VERS.032008, 0G0FT5G, 0G0FT5G-VERS.032008, 0G0FT7G, 1G0FT1G, 1G0FT1G-VERS.032008, 1G0FT2G, 1G0FT2G-VERS.032008, 1G0FT3G, 1G0FT3G-VERS.032008, 1G0FT4G, 1G0FT4G-VERS.032008, 1G0FT6E, 1G0FT6G, 1G0FT6G-VERS.032008, 1G0FT7G, 6040560, 6042490, 6042500, 6043200		



código	105335	referencia	34A1520
descripción	quemador tubular acodado L 605mm An 247mm ømm Hmm horno		
Para modelos:	31, 31TC, 31TP, 32, 32TC, 32TP, 32TPV, 32V		



código	105343	referencia	34A1840 34A1841
descripción	quemador tubular 3 filas L 585mm An 270mm ømm plancha grill		
Para modelos:	070FT04, 070FT05, 071FT04, 071FT06, 090FT04, 090FT05, 090FT1G, 090FT2G, 090FT4G, 090FT5G, 090FT7G, 091FT04, 091FT06, 0A0FT1G, 0A0FT2G, 0A0FT4G, 0A0FT5G, 0B0FT1G, 0B0FT2G, 0B0FT4G, 0B0FT5G, 0D0FT1G, 0D0FT2G, 0D0FT4G, 0D0FT5G, 190FT15G, 190FT1G, 190FT2G, 190FT3G, 190FT42G, 190FT4G, 190FT6G, 190FT72G, 190FT7G, 1A0FT1G, 1A0FT2G, 1A0FT3G, 1A0FT4G, 1A0FT6G, 1B0FT1G, 1B0FT2G, 1B0FT3G, 1B0FT4G, 1B0FT6G, 1D0FT1G, 1D0FT2G, 1D0FT3G, 1D0FT4G, 1D0FT6G		



código	105337	referencia	34A1880
descripción	quemador tubular acodado L 765mm An 345mm ømm Hmm horno		
Para modelos:	191FAAG, 191FABG, 191FADG, 191TPG, 1A1FA1G, 1A1FA2G, 1A1FA4G, 1A1FA5G, 1A1FAAG, 1A1FABG, 1A1FAS2G, 1A1FASG, 1A1TP0G, 1A1TP0G-VERS.2002, 1D1FA1G, 1D1FA2G, 1D1FA4G, 1D1FA5G, 1D1FAAG, 1D1FABG, 1D1FAS2G, 1D1FASG, 1D1TP0G, 1D1TP0G-VERS.2002, 291FAG, 291TPCG, 2A1FA1G, 2A1FA4G, 2A1FAAG, 2A1FAS2G, 2A1FASG, 2A1TP3G, 2A1TP6G, 2A1TPCG, 2A1TPSG, 2D1FA1G, 2D1FA4G, 2D1FAAG, 2D1FAS2G, 2D1FASG, 2D1TP3G, 2D1TP6G, 2D1TPCG, 2D1TPSG, 391FAG, 3A1FA1G, 3A1FA4G, 3A1FAAG, 3A1FASG, 3D1FA1G...(Otros modelos se puede ver en la tienda web)		



código	105334	referencia	34A0900
descripción	quemador tubular 4 filas L 545mm An 300mm ømm 12kW placa radiante		
Para modelos:	190TP0, 191TPG, 1A0TP0, 1A1FASG, 1A1TP0G, 1A1TP0G-VERS.2002, 1B0TP0, 1D0TP0, 1D1TP0G, 1D1TP0G-VERS.2002, 291TPCG, 2A1FASG, 2A1TP3G, 2A1TP6G, 2A1TPCG, 2A1TPSG, 2D1TP3G, 2D1TP6G, 2D1TPCG, 2D1TPSG, 3A1FASG		



código	105279	referencia	34A1370
descripción	quemador tubular acodado L 770mm An 345mm ømm Hmm horno		
Para modelos:	71D, 71DGG, 71TP, 72D, 72DGG, 72TP, 72TPGG, 72VA, 72VAGG, 72VAS, 72VASGG, 73D, 73DGG, 73VA, 73VAD, 73VADGG, 73VAGG, FS30		





código	104162	referencia	34A1461
descripción	quemador tubular en forma de T L 560mm Anmm ø 40mm placa radiante		
Para modelos:	070FT, 070FTR, 0712VA, 090FAVA, 090FT, 090FTR, 092VA, 092VAGG, 0A0FAVA, 0D0FAVA, 190FAB, 191FABG, 1A0FA2, 1A0FA5, 1A0FAB, 1A0FAS2, 1A1FA2G, 1A1FA5G, 1A1FABG, 1A1FAS2G, 1B0FAS2, 1B1FAS2G, 1D0FA2, 1D0FA5, 1D0FAB, 1D0FAS2, 1D1FA2G, 1D1FA5G, 1D1FABG, 1D1FAS2G, 2A0FAS2, 2A1FAS2G, 2D0FAS2, 2D1FAS2G, 712VA, 72VA, 72VAGG, 72VAS, 72VASGG, 73VA, 73VAD, 73VADGG, 73VAGG		





código	105346	referencia	34A1450
descripción	quemador tubular forma U L 610mm An 205mm ømm Hmm baño maría		
Para modelos:	070BM, 071BM, 090BM, 091BM		



			
1			
código	105304	referencia	34A1640 34A1641
descripción	quemador tubular ø 27mm Anmm Hmm L 425mm salamandra		
Para modelos:	60SM		

			
1			
código	104136	referencia	34A0230
descripción	quemador tubular ømm An 28mm H 42mm L 335mm anchura brida 35mm longitud brida 80mm marmita		
Para modelos:	71PD10, 71PD15, 71PI10, 71PI10A, 91PI10, 91PI10A		

			
1			
código	105347	referencia	34A1510
descripción	quemador tubular ø 27mm Anmm Hmm L 440mm baño maría		
Para modelos:	090BM1G, 0A0BMG, 0D0BMG		

			
1 imagen no disponible			
código	105372	referencia	34A1850
descripción	quemador tubular ømm marmita		
Para modelos:	1G1PD1G, 1G1PI1G, 31PD6, 31PI6		



			
1			
código	105502	referencia	34A1690 34A1690-2
descripción	quemador tubular ø 50mm Anmm Hmm L 424mm horno de convección		
Para modelos:	FC101, FCV101, FCV101-CSA, FCV101DM, FCV101DM-CSA, FCV101DS, FCV101DS-CSA		

			
1 imagen no disponible			
código	105367	referencia	34A1790 34A1793
descripción	quemador tubular ømm sartén basculante		
Para modelos:	1G1BR1G, 31R		

			
1			
código	105697	referencia	34A2310
descripción	quemador tubular ø 50mm Anmm Hmm L 450mm con perno M5x12 anchura brida 65mm longitud brida 71mm marmita		

			
1			
código	105368	referencia	34A1480
descripción	quemador tubular ømm sartén basculante		
Para modelos:	71AR, 91AR		

			
1			
código	107843	referencia	34A0500
descripción	quemador tubular ø 50mm L 550mm anchura brida 57mm longitud brida 57mm 15kW horno a vapor combinado		
Para modelos:	FC241G, FCV241G, FCV241G-CSA, FCV241GDM, FCV241GDM-CSA, FCV241GDS, FCV241GDS-CSA, FCV401DM, FCV401DM-CSA		

parrillas para grill de piedra volcánica			
			
1			
código	211000	referencia	36A4230 36A5290
descripción	parrilla de piedra volcánica L 600mm An 330mm H 22mm		
Para modelos:	0A0GRG, 0D0GRG, 1A0GRG, 1D0GRG		
accesorios para	211000		
	código	693000	referencia 35Y2780
	resorte para parrilla de piedra volcánica		



quemadores tubulares



1

código	105401	referencia	3007720 34A2120
descripción	quemador L 300mm An 75mm H 42mm para freidora		
Para modelos:	06WFR3GD, 091FR1G, 091FR1GD, 091FR1I, 091FR1IA, 091FR1ID, 091FR1ID-VERS.052012, 091FR1I-VERS.032012, 091FR3G, 091FR3GD, 0A1FR1GD-VERS.2004, 0A1FR1G-VERS.2004, 0A1FR3G, 0A1FR3GD, 0D1FR1GD-VERS.2004, 0D1FR1G-VERS.2004, 0D1FR3G, 0D1FR3GD, 0G1FR3G, 0G1FR3GD, 10WFR4GD, 191FR2G, 191FR2GD, 191FR2I, 191FR2ID, 191FR2ID-VERS.092012, 191FR2I-VERS.032012, 191FR4G, 191FR4GD, 1A1FR2GD-VERS.2004, 1A1FR2G-VERS.2004, 1A1FR4G, 1A1FR4GD, 1D1FR2GD-VERS.2004, 1D1FR2G-VERS.2004, 1D1FR4G, 1D1FR4GD, 1G1FR4G, 1G1FR4GD		



1

código	105344	referencia	34A1670
descripción	quemador tubular L 305mm An 55mm H 63mm para cocedora de pasta/freidora ovalado		
Para modelos:	0A1FR1G, 0A1FR1GD, 0B1FR1G, 0B1FR1GD, 0D1FR1G, 0D1FR1GD, 1A1FR2G, 1A1FR2GD, 1D1FR2G, 1D1FR2GD, 30CPS, 30F1, 30F1B, 30FS2, 30FS2B, 70CP, 70F1, 70F1B, 71CP, 71CP2, 71F2, 71F2B, 90CP, 90F110B, 91CP, 91F210, 91F210B, 91F223B		

quemadores para placas radiantes



1

código	105332	referencia	34A1650
descripción	quemador para placas radiantes ø 162mm H 117mm L 330mm		
Para modelos:	031TP, 1G0TP0, 1G1TP0G, 2G1TP3G, 31TP, 32TP, 32TPV		

sopletes



1

código	108153	referencia	6300748
descripción	soplador para quemador horno a vapor combinado 230V 65W dist. del agujero 50mm NRG118/0800-3612-030204		
Para modelos:	BX101G, BX101G-VERS.122013, BX122G, BX122G-VERS.122013, BX61G, BX61G-VERS.122013, BX82G, BX82G-VERS.122013, FX101G1, FX101G1R, FX101G2, FX101G2C, FX101G2C-VERS.032014, FX101G2R, FX101G2R-VERS.032014, FX101G2-VERS.032014, FX101G3, FX101G3C, FX101G3C-VERS.022014, FX101G3R, FX101G3R-VERS.022014, FX101G3-VERS.022014, FX10G2CR, FX10G2CR-VERS.032014, FX10G3CR, FX10G3CR-VERS.022014, FX122G1, FX122G2, FX122G2C, FX122G2T, FX122G2T-VERS.032014, FX122G3, FX122G3C, FX122G3T, FX122G3T-VERS.022014, FX12G3CT, FX12G3CT-VERS.022014, FX201G2, FX201G2P, FX201G2P-VERS.032014, FX201G2-VERS.032014, FX201G3P, FX201G3-VERS.022014, FX202G2, FX202G2-VERS.032014, FX202G3, FX202G3-VERS.022014, FX61G1, FX61G1R, FX61G2... (Otros modelos se puede ver en la tienda web)		

accesorios

juntas



1

código	109208	referencia	36E3770
descripción	junta L 89mm An 89mm D1 ø 76mm espesor 1mm agujero ø 6mm dist. del agujero 69mm para cámara quemador horno a vapor combinado		
Para modelos:	FC1011G, FC1221G, FC611G, FM1011G1, FM1011G1-VERS.2006, FM1011G2, FM1011G2-VERS.2006, FM1011G3, FM1011G3-VERS.2006, FM1221G1, FM1221G1-VERS.2006, FM1221G2, FM1221G2-VERS.2006, FM1221G3, FM1221G3-VERS.2006, FM2011G2-VERS.2006, FM2011G3-VERS.2006, FM2021G1, FM2021G2, FM2021G2-VERS.2006, FM2021G3, FM2021G3-VERS.2006, FM611G1, FM611G1-VERS.2006, FM611G2, FM611G2-VERS.2006, FM611G3, FM611G3-VERS.2006, FM721G1, FM721G1-VERS.2006, FM721G2, FM721G2-VERS.2006, FM721G3, FM721G3-VERS.2006		











1

código	109207	referencia	36E3390
descripción	junta L 89mm An 89mm ø 76mm espesor 3mm agujero ø 4mm dist. del agujero 69mm para cámara quemador horno a vapor combinado		
Para modelos:	FC1011G, FC1221G, FC611G, FM1011G1, FM1011G1-VERS.2006, FM1011G2, FM1011G2-VERS.2006, FM1011G3, FM1011G3-VERS.2006, FM1221G1, FM1221G1-VERS.2006, FM1221G2, FM1221G2-VERS.2006, FM1221G3, FM1221G3-VERS.2006, FM2011G2-VERS.2006, FM2011G3-VERS.2006, FM2021G1, FM2021G2, FM2021G2-VERS.2006, FM2021G3, FM2021G3-VERS.2006, FM611G1, FM611G1-VERS.2006, FM611G2, FM611G2-VERS.2006, FM611G3, FM611G3-VERS.2006, FM721G1, FM721G1-VERS.2006, FM721G2, FM721G2-VERS.2006, FM721G3, FM721G3-VERS.2006		



boquillas de gas inyectores principales

boquillas de gas M6x0,75

	1		
código	102570	referencia	33T3060
descripción	boquilla de gas rosca M6x0,75 EC 8 taladro ø 1.15mm		
	1		
código	106744	referencia	33T4490
descripción	boquilla de gas rosca M6x0,75 EC 8 taladro ø 1.3mm		
	1		
código	102571	referencia	3033010
descripción	boquilla de gas rosca M6x0,75 EC 8 taladro ø 1.4mm		
	1		
código	106745	referencia	3033000
descripción	boquilla de gas rosca M6x0,75 EC 8 taladro ø 1.55mm		
	1		
código	102569	referencia	33T4480
descripción	boquilla de gas rosca M6x0,75 EC 8 taladro ø 1.5mm		
	1		
código	102564	referencia	33T4230
descripción	boquilla de gas rosca M6x0,75 EC 8 taladro ø 1.65mm		
	1		
código	102565	referencia	33T4250
descripción	boquilla de gas rosca M6x0,75 EC 8 taladro ø 1.75mm		
	1		
código	102961	referencia	33T4240
descripción	boquilla de gas rosca M6x0,75 EC 8 taladro ø 1.85mm		



	1		
código	102567	referencia	33T3050
descripción	boquilla de gas rosca M6x0,75 EC 8 taladro ø 1mm		

boquillas de gas M8x1

	1		
código	104737	referencia	3032930
descripción	boquilla de gas rosca M8x1 EC 10 taladro ø 0.5mm		
Para modelos:	BX61E, BX61E-VERS.122013, BX61G, BX61G-VERS.122013, FC611E, FC611G, FM1221E1-VERS.2006, FM1221E2-VERS.2006, FM1221E3-VERS.2006, FM1221G1-VERS.2006, FM1221G2-VERS.2006, FM1221G3-VERS.2006, FM2011E2-VERS.2006, FM2011E3-VERS.2006, FM2011G2-VERS.2006, FM2011G3-VERS.2006, FM2021E2-VERS.2006, FM2021E3-VERS.2006, FM2021G2-VERS.2006, FM2021G3-VERS.2006, FM611E1, FM611E1-VERS.2006, FM611E2, FM611E2-VERS.2006, FM611E3, FM611E3-VERS.2006, FM611G1, FM611G1-VERS.2006, FM611G2, FM611G2-VERS.2006, FM611G3, FM611G3-VERS.2006, FX61E1, FX61E1R, FX61E2, FX61E2C, FX61E2CR, FX61E2CR-VERS.032014, FX61E2C-VERS.032014, FX61E2R, FX61E2R-VERS.032014, FX61E2-VERS.032014, FX61E3, FX61E3C, FX61E3CR, FX61E3CR-VERS.022014, FX61E3C-VERS.022014, FX61E3R, FX61E3R-VERS.022014, FX61E3-VERS.022014...(Otros modelos se puede ver en la tienda web)		

	1		
código	104736	referencia	3032920
descripción	boquilla de gas rosca M8x1 EC 10 taladro ø 1.85mm		
Para modelos:	FC1011E, FC1011G, FC1221E, FC1221G, FC611E, FC611G, FM1011E1, FM1011E1-VERS.2006, FM1011E2, FM1011E2-VERS.2006, FM1011E3, FM1011E3-VERS.2006, FM1011G1, FM1011G1-VERS.2006, FM1011G2, FM1011G2-VERS.2006, FM1011G3, FM1011G3-VERS.2006, FM1221E1-VERS.2006, FM1221E2-VERS.2006, FM1221E3, FM1221E3-VERS.2006, FM1221G1-VERS.2006, FM1221G2-VERS.2006, FM1221G3, FM1221G3-VERS.2006, FM2011E2-VERS.2006, FM2011E3-VERS.2006, FM2011G2-VERS.2006, FM2011G3-VERS.2006, FM611E1, FM611E1-VERS.2006, FM611E2, FM611E2-VERS.2006, FM611E3, FM611E3-VERS.2006, FM611G1, FM611G1-VERS.2006, FM611G2, FM611G2-VERS.2006, FM611G3, FM611G3-VERS.2006, FM721E3, FM721G3		

boquillas de gas M 10x1

	1		
código	100670	referencia	33T3880
descripción	boquilla de gas rosca M10x1 taladro ø 0.9mm L 30mm EC 12		
	1		
código	106400	referencia	33T0650
descripción	boquilla de gas rosca M10x1 taladro ø 1.1mm L 30mm EC 12		





			
código	101974	referencia	33T3910
descripción	boquilla de gas rosca M10x1 taladro ø 1.35mm L 30mm EC 12		

			
código	101975	referencia	33T3980
descripción	boquilla de gas rosca M10x1 taladro ø 1.55mm L 30mm EC 12		

			
código	100816	referencia	33T3900
descripción	boquilla de gas rosca M10x1 taladro ø 1.5mm EC 12		

			
código	100153	referencia	33T1700
descripción	boquilla de gas rosca M10x1 taladro ø 1.6mm L 30mm EC 12		

			
código	106402	referencia	33T0710
descripción	boquilla de gas rosca M10x1 taladro ø 1.75mm L 30mm EC 12		

			
código	106407	referencia	33T1750
descripción	boquilla de gas rosca M10x1 taladro ø 1.85mm L 30mm EC 12		

			
código	106403	referencia	33T1920
descripción	boquilla de gas rosca M10x1 taladro ø 1.9mm L 30mm EC 12		

			
código	100676	referencia	33T0690
descripción	boquilla de gas rosca M10x1 taladro ø 1mm L 30mm EC 12		

			
código	100673	referencia	33T1990
descripción	boquilla de gas rosca M10x1 taladro ø 2.05mm L 30mm EC 12		

			
código	106401	referencia	33T0720
descripción	boquilla de gas rosca M10x1 taladro ø 2.2mm L 30mm EC 12		

			
código	101973	referencia	33T3920
descripción	boquilla de gas rosca M10x1 taladro ø 2.3mm L 30mm EC 12		

			
código	107898	referencia	33T0550
descripción	boquilla de gas rosca M10x1 taladro ø 2.7mm L 30mm EC 12		

			
código	106404	referencia	33T0750
descripción	boquilla de gas rosca M10x1 taladro ø 2.8mm L 30mm EC 12		

			
código	106405	referencia	33T3360
descripción	boquilla de gas rosca M10x1 taladro ø 2mm L 30mm EC 12		

			
código	106406	referencia	33T2280
descripción	boquilla de gas rosca M10x1 taladro ø 3.5mm L 30mm EC 12		

			
código	101972	referencia	33T4030
descripción	boquilla de gas rosca M10x1 taladro ø 3.6mm L 30mm EC 12		

			
código	106408	referencia	33T3370
descripción	boquilla de gas rosca M10x1 taladro ø 3mm L 30mm EC 12		

			
código	106471	referencia	33T1520
descripción	boquilla de gas rosca M10x1 EC 12 taladro ø 0.7mm		



1			
código	106472	referencia	33T1550
descripción	boquilla de gas rosca M10x1 EC 12 taladro ø 0.85mm		

1			
código	106452	referencia	33T3760
descripción	boquilla de gas rosca M10x1 EC 12 taladro ø 1.35mm		

1			
código	106465	referencia	33T1540
descripción	boquilla de gas rosca M10x1 EC 12 taladro ø 0.8mm		

1			
código	106453	referencia	33T1660
descripción	boquilla de gas rosca M10x1 EC 12 taladro ø 1.4mm		

1			
código	106451	referencia	33T1560
descripción	boquilla de gas rosca M10x1 EC 12 taladro ø 0.9mm		

1			
código	101961	referencia	33T3490
descripción	boquilla de gas rosca M10x1 EC 12 taladro ø 1.55mm		

1			
código	106473	referencia	33T1590
descripción	boquilla de gas rosca M10x1 EC 12 taladro ø 1.05mm		

1			
código	106467	referencia	33T0790
descripción	boquilla de gas rosca M10x1 EC 12 taladro ø 1.6mm		

1			
código	106466	referencia	33T1610
descripción	boquilla de gas rosca M10x1 EC 12 taladro ø 1.15mm		

1			
código	106468	referencia	33T1720
descripción	boquilla de gas rosca M10x1 EC 12 taladro ø 1.7mm		

1			
código	106611	referencia	33T1630
descripción	boquilla de gas rosca M10x1 EC 12 taladro ø 1.25mm		

1			
código	106455	referencia	33T1380
descripción	boquilla de gas rosca M10x1 EC 12 taladro ø 1.85mm		





			
1			
código	106454	referencia	33T1740
descripción	boquilla de gas rosca M10x1 EC 12 taladro ø 1.8mm		

			
1			
código	106469	referencia	33T1850
descripción	boquilla de gas rosca M10x1 EC 12 taladro ø 2.5mm		

			
1			
código	106456	referencia	33T1770
descripción	boquilla de gas rosca M10x1 EC 12 taladro ø 1.95mm		

			
1			
código	106460	referencia	33T1860
descripción	boquilla de gas rosca M10x1 EC 12 taladro ø 2.6mm		

			
1			
código	106457	referencia	33T1790
descripción	boquilla de gas rosca M10x1 EC 12 taladro ø 2.05mm		

			
1			
código	106461	referencia	33T1880
descripción	boquilla de gas rosca M10x1 EC 12 taladro ø 2.8mm		

			
1			
código	106458	referencia	33T1800
descripción	boquilla de gas rosca M10x1 EC 12 taladro ø 2.1mm		

			
1			
código	106462	referencia	33T3750
descripción	boquilla de gas rosca M10x1 EC 12 taladro ø 2.9mm		

			
1			
código	106475	referencia	33T1820
descripción	boquilla de gas rosca M10x1 EC 12 taladro ø 2.2mm		

			
1			
código	106474	referencia	33T1780
descripción	boquilla de gas rosca M10x1 EC 12 taladro ø 2mm		

			
1			
código	106459	referencia	33T1840
descripción	boquilla de gas rosca M10x1 EC 12 taladro ø 2.4mm		

			
1			
código	106464	referencia	33T1930
descripción	boquilla de gas rosca M10x1 EC 12 taladro ø 3.4mm		





			
1			
código	106463	referencia	33T1900
descripción	boquilla de gas rosca M10x1 EC 12 taladro ø 3mm		

			
1			
código	100540	referencia	33T1620
descripción	boquilla de gas rosca M10x1 EC 12 taladro ø 1.2mm		

			
1			
código	101997	referencia	33T4210
descripción	boquilla de gas rosca M10x1 EC 11 taladro ø 1.4mm		

			
1			
código	100387	referencia	33T1670
descripción	boquilla de gas rosca M10x1 EC 12 taladro ø 1.45mm		

			
1			
código	100380	referencia	33T0070
descripción	boquilla de gas rosca M10x1 EC 12 taladro ø 0.7mm		

			
1			
código	102151	referencia	33T0110
descripción	boquilla de gas rosca M10x1 EC 12 taladro ø 1.4mm		

			
1			
código	100381	referencia	33T0080
descripción	boquilla de gas rosca M10x1 EC 12 taladro ø 0.85mm		

			
1			
código	100383	referencia	33T0120
descripción	boquilla de gas rosca M10x1 EC 12 taladro ø 1.6mm		

			
1			
código	100382	referencia	33T0090
descripción	boquilla de gas rosca M10x1 EC 12 taladro ø 1.05mm		

			
1			
código	100384	referencia	33T0130
descripción	boquilla de gas rosca M10x1 EC 12 taladro ø 1.8mm		

			
1			
código	100539	referencia	33T0390
descripción	boquilla de gas rosca M10x1 EC 12 taladro ø 1.15mm		

			
1			
código	100544	referencia	33T1760
descripción	boquilla de gas rosca M10x1 EC 12 taladro ø 1.9mm		
Para modelos:	91AR		





			
1			
código	100537	referencia	33T1580
descripción	boquilla de gas rosca M10x1 EC 12 taladro ø 1mm		

			
1			
código	100386	referencia	33T0160
descripción	boquilla de gas rosca M10x1 EC 12 taladro ø 2.2mm		

			
1			
código	100388	referencia	33T0170
descripción	boquilla de gas rosca M10x1 EC 12 taladro ø 2.3mm		

			
1			
código	106430	referencia	33T0190
descripción	boquilla de gas rosca M10x1 EC 12 taladro ø 2.6mm		

			
1			
código	107466	referencia	33T4640
descripción	boquilla de gas rosca M10x1 EC 12 taladro ø 3.05mm		

			
1			
código	106431	referencia	33T0510
descripción	boquilla de gas rosca M10x1 EC 12 taladro ø 3.3mm		

			
1			
código	106300	referencia	33T2420
descripción	boquilla de gas rosca M10x1 EC 12 taladro ø 0.9mm L 31mm		

			
1			
código	106301	referencia	33T0310
descripción	boquilla de gas rosca M10x1 EC 12 taladro ø 1.05mm L 31mm		

			
1			
código	106302	referencia	33T2140
descripción	boquilla de gas rosca M10x1 EC 12 taladro ø 1.25mm L 31mm		

			
1			
código	106305	referencia	33T3210
descripción	boquilla de gas rosca M10x1 EC 12 taladro ø 1.5mm L 31mm		

			
1			
código	102236	referencia	33T1310
descripción	boquilla de gas rosca M10x1 EC 12 taladro ø 2.1mm		

			
1			
código	106303	referencia	33T0320
descripción	boquilla de gas rosca M10x1 EC 12 taladro ø 2.3mm L 31mm		

boquillas piloto

boquilla de quemador piloto AB

			
1			
código	106237	referencia	33T1510
descripción	boquilla de quemador piloto gas natural/licuado código 25 taladro ø 0.25mm UE 1 pzs		

boquillas piloto JUNKERS

serie CB 50203_/503_

			
1			
código	100220	referencia	33T0540
descripción	boquilla de quemador piloto gas licuado presión de gas 50mbar código 2 UE 1 pzs apto para JUNKERS CB503_		





			
1			
código	100224	referencia	33T0560
descripción	boquilla de quemador piloto gas natural presión de gas 25mbar código 26 UE 1 pzs apto para JUNKERS CB503_		

boquillas piloto SIT

serie 100

			
1			
código	102972	referencia	33T3130
descripción	boquilla de quemador piloto gas natural código 40 taladro ø 0.4mm UE 1 pzs		

			
1			
código	100246	referencia	33T0410
descripción	boquilla de quemador piloto gas natural taladro ø 0.35mm UE 1 pzs rosca M8x0,75		

			
1			
código	107171	referencia	33T0340
descripción	boquilla de quemador piloto SIT gas natural/licuado taladro ø 0.25mm UE 1 pzs		

serie 160

			
1			
código	107649	referencia	33T4300
descripción	boquilla de quemador piloto SIT gas licuado código 20 UE 1 pzs		

			
1			
código	107650	referencia	33T3310
descripción	boquilla de quemador piloto SIT gas licuado código 30 UE 1 pzs		

			
1			
código	107173	referencia	33T4310
descripción	boquilla de quemador piloto SIT gas natural código 35 UE 1 pzs apto para serie 160 boquilla ø 0.35mm		

			
1			
código	107174	referencia	33T2870
descripción	boquilla de quemador piloto SIT gas natural código 41 UE 1 pzs		

diversas boquillas piloto

ANGELO PO

			
1			
código	100253	referencia	33T0040
descripción	boquilla de quemador piloto gas licuado código 2 presión de gas 50mbar UE 1 pzs latón		

			
1			
código	100240	referencia	33T0240
descripción	boquilla de quemador piloto gas licuado código 39 presión de gas 30mbar latón		

accesorios para	100240		
	código	100240	referencia 33T0240
	boquilla de quemador piloto gas licuado código 39 presión de gas 30mbar latón		
	código	100241	referencia 33T0050
	boquilla de quemador piloto gas natural código 13 presión de gas 25mbar taladro ø 0.4mm UE 1 pzs latón		
	código	100909	referencia 36Q0060
	tornillo de racor rosca M10x1 para tubo ø 6mm UE 1 pzs		
	código	101282	referencia —
	anillo cortante para tubo ø 4mm L 7.4mm UE 1 pzs		
	código	101283	referencia —
	tornillo de racor rosca M10x1 para tubo ø 4mm UE 1 pzs		
	código	101288	referencia —
	anillo cortante para tubo ø 6mm L 6mm aluminio UE 1 pzs ø ext. 8.5mm		

			
1			
código	100241	referencia	33T0050
descripción	boquilla de quemador piloto gas natural código 13 presión de gas 25mbar taladro ø 0.4mm UE 1 pzs latón		

boquillas bypass

boquillas bypass EGA

			
1			
código	100357	referencia	33T2340
descripción	boquilla bypass EGA tipo serie 31248 taladro ø 0.7mm		

			
1			
código	100328	referencia	33T2370
descripción	boquilla bypass EGA tipo serie 31248 taladro ø 0.8mm		

			
1			
código	100363	referencia	33T2360
descripción	boquilla bypass EGA tipo serie 31248 taladro ø 1.5mm		

			
1			
código	106236	referencia	33T2350
descripción	boquilla bypass EGA tipo serie 31248 taladro ø 1.7mm		

boquillas bypass PEL20/21

			
1			
código	100408	referencia	33T3630
descripción	boquilla bypass tipo PEL20/21 taladro ø 0.35mm rosca M5x0,5		

			
1			
código	100553	referencia	33T1450
descripción	boquilla bypass tipo PEL20/21 taladro ø 0.4mm rosca M5x0,5		

			
1			
código	100550	referencia	33T3530
descripción	boquilla bypass tipo PEL20/21 taladro ø 0.55mm rosca M5x0,5		

			
1			
código	100548	referencia	33T3640
descripción	boquilla bypass tipo PEL20/21 taladro ø 0.65mm rosca M5x0,5		

			
1			
código	100278	referencia	33T2640
descripción	boquilla bypass tipo PEL20/21 taladro ø 0.75mm rosca M5x0,5		

			
1			
código	100552	referencia	33T3650
descripción	boquilla bypass tipo PEL20/21 taladro ø 0.7mm rosca M5x0,5		

			
1			
código	100527	referencia	33T3660
descripción	boquilla bypass tipo PEL20/21 taladro ø 0.85mm rosca M5x0,5		

			
1			
código	100555	referencia	33T3540
descripción	boquilla bypass tipo PEL20/21 taladro ø 0.8mm rosca M5x0,5		

			
1			
código	100556	referencia	33T3810
descripción	boquilla bypass tipo PEL20/21 taladro ø 0.95mm rosca M5x0,5		

			
1			
código	100557	referencia	33T3670
descripción	boquilla bypass tipo PEL20/21 taladro ø 1.05mm rosca M5x0,5		









			
1			
código	100530	referencia	33T4260
descripción	boquilla bypass tipo PEL20/21 taladro ø 1.1mm rosca M5x0,5		

			
1			
código	100532	referencia	33T4270
descripción	boquilla bypass tipo PEL20/21 taladro ø 1.2mm rosca M5x0,5		

			
1			
código	100533	referencia	33T4290
descripción	boquilla bypass tipo PEL20/21 taladro ø 1.3mm rosca M5x0,5		



boquillas bypass PEL20			
			
1			
código	100259	referencia	33T1180
descripción	boquilla bypass tipo PEL22 taladro ø 0.35mm rosca M6x0,5		
			
1			
código	100281	referencia	33T1690
descripción	boquilla bypass tipo PEL22 taladro ø 0.4mm rosca M6x0,5		
			
1			
código	100391	referencia	33T2120
descripción	boquilla bypass tipo PEL22 taladro ø 0.55mm rosca M6x0,5		
			
1			
código	100390	referencia	33T1190
descripción	boquilla bypass tipo PEL22 taladro ø 0.5mm rosca M6x0,5		
			
1			
código	100428	referencia	33T1210
descripción	boquilla bypass tipo PEL22 taladro ø 0.65mm rosca M6x0,5		
			
1			
código	100432	referencia	33T2160
descripción	boquilla bypass tipo PEL22 taladro ø 0.75mm rosca M6x0,5		
			
1			
código	100409	referencia	33T3970
descripción	boquilla bypass tipo PEL22 taladro ø 0.8mm rosca M6x0,5		
			
1			
código	100433	referencia	33T3850
descripción	boquilla bypass tipo PEL22 taladro ø 0.9mm rosca M6x0,5		
			
1			
código	100435	referencia	33T2250
descripción	boquilla bypass tipo PEL22 taladro ø 1.05mm rosca M6x0,5		

boquillas bypass PEL20			
			
1			
código	102974	referencia	33T0590
descripción	boquilla bypass tipo PEL22 taladro ø 1.25mm rosca M6x0,5		
			
1			
código	106235	referencia	33T1480
descripción	boquilla bypass tipo PEL23/24 taladro ø 0.4mm rosca M8x0,5		
			
1			
código	100448	referencia	33T2500
descripción	boquilla bypass tipo PEL23/24 taladro ø 0.5mm rosca M8x0,5		
			
1			
código	100494	referencia	33T4050
descripción	boquilla bypass tipo PEL23/24 taladro ø 0.75mm rosca M8x0,5		
			
1			
código	100497	referencia	33T4060
descripción	boquilla bypass tipo PEL23/24 taladro ø 0.8mm rosca M8x0,5		
			
1			
código	100598	referencia	33T2490
descripción	boquilla bypass tipo PEL23/24 taladro ø 0.95mm rosca M8x0,5		
			
1			
código	100597	referencia	33T2690
descripción	boquilla bypass tipo PEL23/24 taladro ø 0.9mm rosca M8x0,5		
			
1			
código	100628	referencia	33T3280
descripción	boquilla bypass tipo PEL23/24 taladro ø 1.05mm rosca M8x0,5		



1			
código	100667	referencia	33T2720
descripción	boquilla bypass tipo PEL23/24 taladro ø 1.35mm rosca M8x0,5		



1			
código	100677	referencia	33T2660
descripción	boquilla bypass tipo PEL23/24 taladro ø 1.45mm rosca M8x0,5		

juegos de boquillas de gas



1			
código	106550	referencia	6018370 60A0680
descripción	juego de boquillas gas licuado ANGELO PO		



1			
código	102171	referencia	6018090
descripción	juego de boquillas de gas		



1			
código	102610	referencia	6018330 60A0640
descripción	juego de boquillas de gas gas licuado 2 llamas ANGELO PO		



1			
código	102622	referencia	6012660
descripción	juego de boquillas de gas gas licuado ANGELO PO		
Para modelos:	1A1FA1G, 1A1FA2G, 1A1FA4G, 1A1FA5G, 1A1TP0G-VERS.2002, 1D1FA1G, 1D1FA2G, 1D1FA4G, 1D1FA5G, 1D1TP0G-VERS.2002, 2A1FA1G, 2A1FA4G, 2A1TP3G, 2A1TP6G, 2D1FA1G, 2D1FA4G, 2D1TP3G, 2D1TP6G, 3A1FA1G, 3A1FA4G, 3D1FA1G, 3D1FA4G		



1			
código	102617	referencia	6018180 60A0490
descripción	juego de boquillas de gas gas licuado cocedora de pasta de gas 2 senos ANGELO PO		



1			
código	102623	referencia	6018190 60A0500
descripción	juego de boquillas de gas gas licuado cocedora de pasta de gas ANGELO PO		



1			
código	102624	referencia	6018170 60A0480
descripción	juego de boquillas de gas gas licuado cocedora de pasta de gas ANGELO PO		



1			
código	102616	referencia	6018410 60A0720
descripción	juego de boquillas de gas gas licuado cocina de plancha radiante ANGELO PO		



1

código	102615	referencia	6018420 60A0730
descripción	juego de boquillas de gas gas licuado cocina de plancha radiante con horno de gas ANGELO PO		

1

código	102625	referencia	6018270 60A0580
descripción	juego de boquillas de gas gas licuado freidora a gas 2 calderas ANGELO PO		

1

código	102626	referencia	6018260 60A0570
descripción	juego de boquillas de gas gas licuado freidora a gas 1 caldera ANGELO PO		

1

código	102613	referencia	6018340 60A0650
descripción	juego de boquillas de gas gas licuado para cocina de gas 4 ANGELO PO		

1

código	102629	referencia	6018240 60A0550
descripción	juego de boquillas de gas gas licuado freidora a gas 1 caldera ANGELO PO		

1

código	102611	referencia	6018360 60A0670
descripción	juego de boquillas de gas gas licuado para cocina de gas 4 con horno de gas ANGELO PO		

1

código	102618	referencia	6018250 60A0560
descripción	juego de boquillas de gas gas licuado freidora a gas 2 calderas ANGELO PO		

1

código	102619	referencia	6018430 60A0740
descripción	juego de boquillas de gas gas licuado para plancha radiante con cocina y horno de gas ANGELO PO		

1

código	102621	referencia	6012700
descripción	juego de boquillas de gas gas licuado potencia nominal 5.5KW ANGELO PO		
Para modelos:	0A0FA1, 0A0FA4, 0D0FA1, 0D0FA4, 1A0FA1, 1A0FA2, 1A0FA4, 1A0FA5, 1A1FA1G, 1A1FA2G, 1A1FA4G, 1A1FA5G, 1D0FA1, 1D0FA2, 1D0FA4, 1D0FA5, 1D1FA1G, 1D1FA2G, 1D1FA4G, 1D1FA5G, 2A0FA1, 2A0FA4, 2A1FA1G, 2A1FA4G, 2A1TP3G, 2A1TP6G, 2D0FA1, 2D0FA4, 2D1FA1G, 2D1FA4G, 2D1TP3G, 2D1TP6G, 3A1FA1G, 3A1FA4G, 3D1FA1G, 3D1FA4G		



1

código	102620	referencia	6012680
descripción	juego de boquillas de gas gas licuado potencia nominal 7.5KW ANGELO PO		



1

código	106808	referencia	6025800
descripción	juego de boquillas de gas gas natural ANGELO PO		



1

código	106807	referencia	6018060 60A0370
descripción	juego de boquillas de gas gas natural ANGELO PO 0G0FT		



1

código	102614	referencia	6018290 60A0600
descripción	juego de boquillas de gas gas natural para cocina de gas 4 ANGELO PO		



1

código	102612	referencia	6018320 60A0630
descripción	juego de boquillas de gas gas natural para cocina de gas 6 con horno de gas ANGELO PO		

materiales auxiliares de gas

uniones roscadas

adaptador





1

código	103097	referencia	33Q2870
descripción	unión roscada para termostato		
Para modelos:	1A1PI1G, 1A1PI1GA, 1D1PI1G, 1D1PI1GA, 1G1PI1G, 3PI6, 71PI10, 71PI10A, 91PI10, 91PI10A		

anillos cortantes







1

código	101286	referencia	36Q0020
descripción	anillo cortante int.ø 6mm UE 1 pzs		
Para modelos:	04WFAAV, 08WFA4E, 08WFA4G, 08WFAAE, 08WFAAG, 08WFAAV, 090FAA, 0A0FA1, 0A0FA4, 0A0FAA, 0D0FA1, 0D0FA4, 0D0FAA, 0G0FA0, 12WFA6E, 12WFA6G, 12WFAAA, 12WFAAE, 12WFAAG, 12WFAAN, 190FA, 190FAA, 190FAB, 190FAD, 191FAAE, 191FAAG, 191FABG, 191FADG, 191FAE, 191FAG, 1A0FA1, 1A0FA2, 1A0FA4, 1A0FA5, 1A0FAA, 1A0FAB, 1A1FA1G, 1A1FA2G, 1A1FA4G, 1A1FA5G, 1A1FAAG, 1A1FABG, 1D0FA1, 1D0FA2, 1D0FA4, 1D0FA5, 1D0FAA, 1D0FAB, 1D1FA1G, 1D1FA2G...(Otros modelos se puede ver en la tienda web)		
accesorios para	101286		
	código	100909	referencia 36Q0060
	descripción	tornillo de racor rosca M10x1 para tubo ø 6mm UE 1 pzs	
	código	101464	referencia —
	descripción	tuerca de racor rosca M12x1 para ø de tubo 6mm	





			
1			
código	103325	referencia	3034890
descripción	anillo cortante para tubo ø 10mm D2 ø 9mm L 8mm		
Para modelos:	08WFA4G, 090FT1G, 090FT2G, 090FT4G, 090FT5G, 090FT7G, 0G0FR5G, 0G0FT1G-VERS.032008, 0G0FT2G-VERS.032008, 0G0FT4G-VERS.032008, 0G0FT5G-VERS.032008, 0G0FT7G, 0G1FR7G, 12WFA6G, 190FT15G, 190FT1G, 190FT2G, 190FT3G, 190FT42G, 190FT4G, 190FT6G, 190FT72G, 190FT7G, 191FAAG, 191FABG, 191FADG, 191FAG, 191TPG, 1A1FAAG, 1A1FABG, 1D1FAAG, 1D1FABG, 1G0FR6G, 1G0FT1G-VERS.032008, 1G0FT2G-VERS.032008, 1G0FT3G-VERS.032008, 1G0FT4G-VERS.032008, 1G0FT6E, 1G0FT6G-VERS.032008, 1G0FT7G, 1G1BR1G, 1G1FR8G, 291FAG, 291FAGF, 291TPCG, 2A1FAAG, 2A1TPCG, 2D1FAAG, 2D1TPCG, 391FAG...(Otros modelos se puede ver en la tienda web)		

			
1			
código	101248	referencia	36Q0030
descripción	anillo cortante para tuboø 12mm UE 1 pzs apto para PEL		
Para modelos:	030FT, 030FTR, 031FT, 031FT04, 031FT06, 031FTR, 031FTRL, 031TP, 032, 070BM, 070D, 070DGG, 070FT, 070FT04, 070FT05, 070FTR, 0712D, 0712VA, 071BM, 071D, 071DGG, 071FT, 071FT04, 071FT06, 071FTR, 071FTRL, 071TP, 072D, 072DGG, 090, 090BM, 090FT, 090FT04, 090FT05, 090FT1G, 090FT2G, 090FT4G, 090FT5G, 090FT7G, 090FTR, 090GG, 090GRG, 091, 091BM, 091FR1G, 091FR1GD, 091FR11, 091FR11A, 091FR1ID, 091FR1ID-VERS.052012...(Otros modelos se puede ver en la tienda web)		
accesorios para	101248		
	código	101251	referencia
			36Q0050
			

			
2			
código	101249	referencia	36Q1700
descripción	anillo cortante para tuboø 10mm UE 1 pzs		
Para modelos:	06WCP1GM, 08WCP1GM, 08WGRGV, 090FAVA, 090GRG, 091CP1G, 091FR3G, 091FR3GD, 0A0BMG, 0A0FAS, 0A0FT1G, 0A0FT2G, 0A0FT4G, 0A0FT5G, 0A0GRG, 0A1CP1G, 0B0FAS, 0B0FT1G, 0B0FT2G, 0B0FT4G, 0B0FT5G, 0B1CP1G, 0D0BMG, 0D0FAS, 0D0FT1G, 0D0FT2G, 0D0FT4G, 0D0FT5G, 0D0GRG, 0D1CP1G, 0G0FR5G, 0G0FT1G, 0G0FT2G, 0G0FT4G, 0G0FT5G, 0G1BR3G, 10WTPGE, 10WTPGV, 190FAB, 190GRG, 190TP0, 191CP1G, 191CP2G, 191FABG, 191FR4G, 191FR4GD, 191PD2G, 191PI1G, 191PI1GA, 191PI2G...(Otros modelos se puede ver en la tienda web)		
accesorios para	101249		
	código	101250	referencia
			36Q0610
			

			
1			
código	101428	referencia	36Q0310
descripción	anillo cortante para tuboø 14mm L 9mm UE 1 pzs ø ext. 16mm		
Para modelos:	04WFAAV, 08WFAAE, 08WFAAG, 08WFAAV, 12WFAAE, 12WFAAG, 1A1BR1G, 1A1BR1GA, 1A1BR2G, 1A1BR2GA, 1A1BR1G, 1A1BR1GA, 1A1BR2G, 1A1BR2GA, 1D1BR1G, 1D1BR1GA, 1D1BR2G, 1D1BR2GA, 2A1BR1G, 2A1BR1GA, 2A1BR2G, 2A1BR2GA, 2D1BR1G, 2D1BR1GA, 2D1BR2G, 2D1BR2GA, FC241, FCV141, FCV141DM, FCV141DS, FCV241, FCV241DM, FCV241DS		

			
1			
código	101278	referencia	36Q0080
descripción	anillo cortante para tuboø 10mm UE 1 pzs		
Para modelos:	030, 031, 032, 04WFAAV, 06WCP1GM, 06WFR3GD, 070BM, 070BME, 071BM, 071BME, 08WCP1GM, 08WFA4E, 08WFA4G, 08WFAAE, 08WFAAG, 08WFAAV, 08WFT1G, 08WFT2G, 08WFT3G, 08WFT4G, 08WFT6G, 08WFT7G, 08WGRGV, 090BM, 090BM1G, 090BME, 090FAA, 090FAVA, 090FT1G, 090FT2G, 090FT4G, 090FT5G, 090FT7G, 090GRG, 091BM, 091BME, 091CP1G, 091FR1EX, 091FR3G, 091FR3GD, 091FR7G, 091FR7GX, 0A0BMG, 0A0FA1, 0A0FA4, 0A0FAA, 0A0FT1G, 0A0FT2G, 0A0FT4G, 0A0FT5G...(Otros modelos se puede ver en la tienda web)		
accesorios para	101278		
	código	100943	referencia
			—
			
	código	101300	referencia
			36Q0830
			
	código	101478	referencia
			—
			

			
1			
código	100870	referencia	36Q1040
descripción	anillo cortante para tuboø 4mm UE 1 pzs apto para serie 160 para quemador piloto		
Para modelos:	04WFAAV, 06WCP1GM, 06WFR3GD, 08WFA4E, 08WFA4G, 08WFAAE, 08WFAAG, 08WFAAV, 08WFT1G, 08WFT2G, 08WFT3G, 08WFT4G, 08WFT6G, 08WFT7G, 08WGRGV, 090BM1G, 090FAA, 090FAVA, 090FT1G, 090FT2G, 090FT4G, 090FT5G, 090FT7G, 090GRG, 091FR1G, 091FR1GD, 091FR3G, 091FR3GD, 0A0FA1, 0A0FA4, 0A0FAA, 0A0FT1G, 0A0FT2G, 0A0FT4G, 0A0FT5G, 0A0GRG, 0A1CP1G, 0B0FT1G, 0B0FT2G, 0B0FT4G, 0B0FT5G, 0B1CP1G, 0D0FA1, 0D0FA4, 0D0FAA, 0D0FT1G, 0D0FT2G, 0D0FT4G, 0D0FT5G, 0D0GRG...(Otros modelos se puede ver en la tienda web)		

piezas T

			
1			
código	541502	referencia	33Q0140
descripción	pieza T rosca 3/8" M - 3/8" M - 3/8" M latón		
Para modelos:	1A1CP1G, 1D1CP1G, 1G1CP2G, 1G1PD1G, 1G1PI1E, 1G1PI1G, 31PD6, 31PI6, 31PIE6, 71CP, 71CP2, 71PD10, 71PD15, 71PI10, 71PI10A, 71PIE15, 71PIE15A, 71PV15, 71PV15A, 91CP, 91PI10, 91PI10A, 91PIE15, 91PIE15A		



tuercas de racor

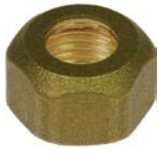

1

código	520666	referencia	36Q0590
descripción	tuerca de racor rosca 1/2" H 12mm		
Para modelos:	091FR1I, 091FR1IA, 091FR1ID, 091FR1ID-VERS.052012, 091FR1I-VERS.032012, 091FR7G, 091FR7GS, 091FR7G-VERS.052012, 091FR7GX, 0A1CP1E, 0A1CP1G, 0B1CP1G, 0D1CP1E, 0D1CP1G, 10CP1IA, 12CP1IA, 18CP2IA, 191FR2I, 191FR2ID, 191FR2ID-VERS.092012, 191FR2I-VERS.032012, 1A1BR1E, 1A1BR1G, 1A1BR1GA, 1A1BR2E, 1A1BR2EA, 1A1BR2G, 1A1BR2GA, 1A1CP1G, 1A1CP2G, 1A1PD1G, 1A1PD2G, 1A1PI1G, 1A1PI1GA, 1A1PI2E, 1A1PI2EA, 1A1PI2V, 1A1PI-2VA, 1D1BR1E, 1D1BR1G, 1D1BR1GA, 1D1BR2E, 1D1BR2EA, 1D1BR2G, 1D1BR2GA, 1D1CP1G, 1D1CP2G, 1D1PD1G, 1D1PD2G, 1D1PI1G... (Otros modelos se puede ver en la tienda web)		



1

código	101300	referencia	36Q0830
descripción	tuerca de racor rosca M16x1,5 tubo ø 10mm		
Para modelos:	030, 031, 032, 04WFAAV, 06WCP1GM, 06WFR3GD, 08WCP1GM, 08WFA4E, 08WFA4G, 08WFAAE, 08WFAAG, 08WFAAV, 08WFT1GV, 08WFT2GV, 08WFT3GV, 08WFT4GV, 08WFT6GV, 08WFT7GV, 08WGRGV, 090FAA, 090GRG, 091CP1G, 0A0BMG, 0A0FA1, 0A0FA4, 0A0FAA, 0A0GRG, 0D0BMG, 0D0FA1, 0D0FA4, 0D0FAA, 0D0GRG, 0G0FA0, 0G0FR5G, 0G1BR3G, 0G1CP1G, 0G1CP1G-VERS.2004, 0G1FR7G, 10WFR4GD, 12WFA6E, 12WFA6G, 12WFAAA, 12WFAAE, 12WFAAG, 12WFAAN, 190FA, 190FAA, 190FAB, 190FAD, 190GRG... (Otros modelos se puede ver en la tienda web)		
accesorios para	101300		
	código	101278	referencia 36Q0080
	anillo cortante para tuboø 10mm UE 1 pzs		



1

código	100944	referencia	36Q0040
descripción	tuerca de racor rosca M18x1,5 para ø de tubo 12mm		
accesorios para	100944		
	código	101273	referencia —
	anillo cortante para tuboø 12mm L 9.5mm latón UE 1 pzs apto para universal		



1

código	101250	referencia	36Q0610
descripción	tuerca de racor rosca M20x1.5 para ø de tubo 10mm		
Para modelos:	04WFAAV, 06WCP1GM, 06WFR3GD, 08WCP1GM, 08WFA4E, 08WFA4G, 08WFAAE, 08WFAAG, 08WFAAV, 08WGRGV, 090FAA, 090FAVA, 090FT1G, 090FT2G, 090FT4G, 090FT5G, 090FT7G, 090GRG, 091CP1G, 091FR3G, 091FR3GD, 0A0FA1, 0A0FA4, 0A0FAA, 0A0FAS, 0A0FT1G, 0A0FT2G, 0A0FT4G, 0A0FT5G, 0A0GRG, 0A1CP1G, 0A1FR3G, 0A1FR3GD, 0B0FAS, 0B0FT1G, 0B0FT2G, 0B0FT4G, 0B0FT5G, 0B1CP1G, 0D0FA1, 0D0FA4, 0D0FAA, 0D0FAS, 0D0FT1G, 0D0FT2G, 0D0FT4G, 0D0FT5G, 0D0GRG, 0D1CP1G, 0D1FR3G... (Otros modelos se puede ver en la tienda web)		
accesorios para	101250		
	código	101249	referencia 36Q1700
	anillo cortante para tuboø 10mm UE 1 pzs		



1

código	101251	referencia	36Q0050
descripción	tuerca de racor rosca M20x1.5 para ø de tubo 12mm		
Para modelos:	030FT, 030FTR, 031FT, 031FTR, 031FTRL, 031TP, 032, 070D, 070DGG, 070FT, 070FTR, 0712D, 0712VA, 071BM, 071D, 071DGG, 071FT, 071FTR, 071FTRL, 071TP, 072D, 072DGG, 090, 090FT, 090FT1G, 090FT2G, 090FT4G, 090FT5G, 090FT7G, 090FTR, 090GG, 090GRG, 091, 091FR1G, 091FR1GD, 091FR1I, 091FR1IA, 091FR1ID, 091FR1ID-VERS.052012, 091FR1I-VERS.032012, 091FR3G, 091FR3GD, 091FR7G, 091FR7GS, 091FR7G-VERS.052012, 091FR7GX, 091FT, 091FTR, 091FTRL, 091GG... (Otros modelos se puede ver en la tienda web)		
accesorios para	101251		
	código	101248	referencia 36Q0030
	anillo cortante para tuboø 12mm UE 1 pzs apto para PEL		



1

código	107892	referencia	36Q0210
descripción	tuerca de racor rosca M20x1.5 para tuboø 14 EC 25		
Para modelos:	04WFAAV, 08WFA4E, 08WFA4G, 08WFAAE, 08WFAAG, 08WFAAV, 12WFA6E, 12WFA6G, 12WFAAA, 12WFAAE, 12WFAAG, 12WFAAN, 191BR2G, 1A1BR1G, 1A1BR1GA, 1A1BR2G, 1A1BR2GA, 1D1BR1G, 1D1BR1GA, 1D1BR2G, 2A1BR1G, 2A1BR1GA, 2A1BR2G, 2A1BR2GA, 2D1BR1G, 2D1BR1GA, 2D1BR2G, 2D1BR2GA, 71AR, 71RA, 91AR, 91RA, FC241, FCV141, FCV141DM, FCV141DS, FCV241, FCV241DM, FCV241DS		



tornillos de racor







1

código	101279	referencia	3032790
descripción	tornillo de racor rosca 3/8" para tuboø 10mm UE 1 pzs		
Para modelos:	06WFR3GD, 08WFA4G, 090BM1G, 090FT1G, 090FT2G, 090FT4G, 090FT5G, 090FT7G, 091FR1EX, 091FR3G, 091FR3GD, 091FR7GS, 091FR7GX, 0A1FR3G, 0A1FR3GD, 0D1FR3G, 0D1FR3GD, 0G0FR5G, 0G0FT1G-VERS.032008, 0G0FT2G-VERS.032008, 0G0FT4G-VERS.032008, 0G0FT5G-VERS.032008, 0G0FT7G, 0G1FR3G, 0G1FR3GD, 0G1FR7G, 10WFR4GD, 12WFA6G, 190BM2G, 190FT15G, 190FT1G, 190FT2G, 190FT3G, 190FT42G, 190FT4G, 190FT6G, 190FT72G, 190FT7G, 191FAAG, 191FABG, 191FADG, 191FAG, 191FR4G, 191FR4GD, 191TPG, 1A1FAAG, 1A1FABG, 1A1FR4G, 1A1FR4GD, 1D1FAAG...(Otros modelos se puede ver en la tienda web)		



1

código	100908	referencia	36Q1000
descripción	tornillo de racor rosca M10x1 para tuboø 4mm UE 1 pzs		
Para modelos:	04WFAAV, 06WCP1GM, 06WFR3GD, 08WFA4E, 08WFA4G, 08WFAAE, 08WFAAG, 08WFAAV, 08WFT1GV, 08WFT2GV, 08WFT3GV, 08WFT4GV, 08WFT6GV, 08WFT7GV, 08WGRGV, 090BM1G, 090FAA, 090FAVA, 090FT1G, 090FT2G, 090FT4G, 090FT5G, 090FT7G, 090GRG, 091FR1G, 091FR1GD, 091FR3G, 091FR3GD, 0A0FA1, 0A0FA4, 0A0FAA, 0A0FT1G, 0A0FT2G, 0A0FT4G, 0A0FT5G, 0A0GRG, 0A1CP1G, 0B0FT1G, 0B0FT2G, 0B0FT4G, 0B0FT5G, 0B1CP1G, 0D0FA1, 0D0FA4, 0D0FAA, 0D0FT1G, 0D0FT2G, 0D0FT4G, 0D0FT5G, 0D0GRG...(Otros modelos se puede ver en la tienda web)		
accesorios para	100908		
	código	100897	referencia —
	anillo cortante para tuboø 4mm UE 1 pzs para quemador piloto		
	código	101246	referencia —
	anillo cortante para tuboø 4mm UE 1 pzs		
	código	101280	referencia —
	anillo cortante para tuboø 4mm UE 1 pzs		
	código	101282	referencia —
	anillo cortante para tuboø 4mm L 7.4mm UE 1 pzs		



1

código	100909	referencia	36Q0060
descripción	tornillo de racor rosca M10x1 para tuboø 6mm UE 1 pzs		
Para modelos:	04WFAAV, 08WFA4E, 08WFA4G, 08WFAAE, 08WFAAG, 08WFAAV, 090FAA, 0A0FA1, 0A0FA4, 0A0FAA, 0D0FA1, 0D0FA4, 0D0FAA, 0G0FA0, 12WFA6E, 12WFA6G, 12WFAAA, 12WFAAE, 12WFAAG, 12WFAAN, 190FA, 190FAA, 190FAB, 190FAD, 191FAAE, 191FAAG, 191FABG, 191FADG, 191FAE, 191FAG, 1A0FA1, 1A0FA2, 1A0FA4, 1A0FA5, 1A0FAA, 1A0FAB, 1A1FA1G, 1A1FA2G, 1A1FA4G, 1A1FA5G, 1A1FAAG, 1A1FABG, 1D0FA1, 1D0FA2, 1D0FA4, 1D0FA5, 1D0FAA, 1D0FAB, 1D1FA1G, 1D1FA2G...(Otros modelos se puede ver en la tienda web)		
accesorios para	100909		
	código	100898	referencia —
	anillo cortante para tuboø 6mm UE 1 pzs para quemador piloto		
	código	101286	referencia 36Q0020
	anillo cortante int.ø 6mm UE 1 pzs		
	código	101287	referencia 36Q0150
	anillo cortante para tuboø 6mm UE 1 pzs		
	código	101288	referencia —
	anillo cortante para tuboø 6mm L 6mm aluminio UE 1 pzs ø ext. 8.5mm		



1

código	100906	referencia	36Q1050
descripción	unión roscada rosca M10x1 para electrodo de encendido latón UE 1 pzs EC 10		
Para modelos:	08WGRGV, 090GRG, 0A0GRG, 0A1CP1G, 0B1CP1G, 0D0GRG, 0D1CP1G, 190GRG, 191CP1G, 1A0GRG, 1A1CP1G, 1A1CP2G, 1A1PD1G, 1A1PD2G, 1A1PI1G, 1A1PI1GA, 1D0GRG, 1D1CP1G, 1D1CP2G, 1D1PD1G, 1D1PD2G, 1D1PI1G, 1D1PI1GA, 1G0GRG, 6042120-08WGRGV		



tuberías de gas

tuberías de gas principales

específico del fabricante



código	102991	referencia	35Z4960
descripción	línea de gas tubo ø 10mm L 300mm con racor		
Para modelos:	070D, 070DGG, 0712D, 0712VA, 071D, 071DGG, 072D, 072DGG, 090, 090GG, 091, 091GG, 092, 092GG, 092VA, 092VAGG, 712D, 712VA, 71D, 71DGG, 71GE, 71GEGG, 72D, 72DGG, 72TP, 72TPGG, 72VA, 72VAGG, 72VAS, 72VASGG, 73D, 73DGG, 73VA, 73VAD, 73VADGG, 73VAGG		



código	107551	referencia	30Z2040
descripción	línea de gas tubo ø 21mm L 745mm An 180mm H 70mm acero		
Para modelos:	1A0FT1G, 1A0FT2G, 1A0FT3G, 1A0FT4G, 1A0FT6G, 1D0FT1G, 1D0FT2G, 1D0FT3G, 1D0FT4G, 1D0FT6G		

universal



código	107589	referencia	3029620
descripción	línea de gas empalme ø10mm L 1250mm ø ext. 13mm inox flexible grosor de la pared 1mm longitud de empalme 30mm		
Para modelos:	08WFT1GV, 08WFT2GV, 08WFT3GV, 08WFT4GV, 08WFT6GV, 08WFT7GV, 1G1FA0G, 1G1FABG, 1G1FAPG, 1G1TP0G, 2G1FA0G, 2G1FABG, 2G1FACG, 2G1FADG, 2G1FADGV, 2G1FAPG, 2G1TP3G		



código	102990	referencia	35Z6650
descripción	línea de gas empalme ø10mm L 320mm ø ext. 13mm inox con racor grosor de la pared 1mm longitud de empalme 30mm		
Para modelos:	071FT, 071FTR, 071FTRL, 091FT, 091FTR, 091FTRL		

código	102987	referencia	3014320
descripción	línea de gas empalme ø10mm L 400mm ø ext. 13mm inox flexible grosor de la pared 1mm longitud de empalme 30mm		
Para modelos:	04WFAAV, 08WFA4E, 08WFA4G, 08WFAAE, 08WFAAG, 08WFAAV, 08WFT1GV, 08WFT2GV, 08WFT3GV, 08WFT4GV, 08WFT6GV, 08WFT7GV, 08WGRGV, 090BM1G, 090FAA, 090FAVA, 090FT1G, 090FT2G, 090FT4G, 090FT5G, 090FT7G, 090GRG, 091FR3G, 091FR3GD, 0A0BMG, 0A0FAA, 0A0FT1G, 0A0FT2G, 0A0FT4G, 0A0FT5G, 0A0GRG, 0A1FR3G, 0A1FR3GD, 0B0FT1G, 0B0FT2G, 0B0FT4G, 0B0FT5G, 0D0BMG, 0D0FAA, 0D0FT1G, 0D0FT2G, 0D0FT4G, 0D0FT5G, 0D0GRG, 0D1FR3G, 0D1FR3GD, 0G0FA0, 0G0FR5G, 0G0FT1G, 0G0FT1G-VERS.032008... (Otros modelos se puede ver en la tienda web)		

código	106655	referencia	3029630
descripción	línea de gas empalme ø10mm L 800mm ø ext. 13mm inox flexible		
Para modelos:	06WFR3GD, 08WCP1GM, 08WFA4G, 10WFR4GD, 12WFA6G, 191FAAG, 191FABG, 191FADG, 191FAG, 191FR4G, 191FR4GD, 191PD2G, 191PI1G, 191PI1GA, 191PI2G, 191PI2GA, 191TPG, 1A1FAAG, 1A1FABG, 1A1FR4G, 1A1FR4GD, 1A1PD1G, 1A1PD2G, 1A1PI1G, 1A1PI1GA, 1A1FAAG, 1D1FABG, 1D1FR4G, 1D1FR4GD, 1D1PD1G, 1D1PD2G, 1D1PI1G, 1D1PI1GA, 1G1BR1G, 1G1FR4G, 1G1FR4GD, 1G1PD1G, 1G1PI1G, 291FAG, 291FAGF, 291TPCG, 2A1FAAG, 2A1TPCG, 2D1FAAG, 2D1TPCG, 391FAG, 3A1FAAG, 3D1FAAG		

código	102460	referencia	3079320 32Z0640
descripción	línea de gas empalme ø4mm L 750mm ø ext. 12mm inox flexible grosor de la pared 0.75mm longitud de empalme 20mm		
Para modelos:	06WCP1GM, 06WFR3GD, 08WFT1GV, 08WFT2GV, 08WFT3GV, 08WFT4GV, 08WFT6GV, 08WFT7GV, 090BM1G, 090FAVA, 091FR1G, 091FR1GD, 091FR3G, 091FR3GD, 0G1CP1G, 0G1CP1G-VERS.2004, 0G1FR3G, 0G1FR3GD, 0G1FR7G, 10WFR4GD, 190BM2G, 190FAB, 190TP0, 191CP1G, 191FABG, 191FR2G, 191FR2GD, 191PD2G, 191PI1G, 191PI1GA, 191PI2G, 191PI2GA, 191TPG, 1A1FR2GD-VERS.2004, 1A1FR2G-VERS.2004, 1A1PD1G, 1A1PD2G, 1A1PI1G, 1A1PI1GA, 1D1FR2GD-VERS.2004, 1D1FR2G-VERS.2004, 1D1PD1G, 1D1PD2G, 1D1PI1G, 1D1PI1GA, 1G0FT1G, 1G0FT2G, 1G0FT3G, 1G0FT4G, 1G0FT6G... (Otros modelos se puede ver en la tienda web)		

tubos piloto

específico del fabricante



código	106991	referencia	3079290
descripción	tubo piloto tubo ø 4mm L 400mm aluminio flexible		
Para modelos:	04WFAAV, 08WFA4E, 08WFA4G, 08WFAAE, 08WFAAG, 08WFAAV, 08WGRGV, 090BM1G, 090FT1G, 090FT2G, 090FT4G, 090FT5G, 090FT7G, 090GRG, 0G0FR5G, 0G0FT1G-VERS.032008, 0G0FT2G-VERS.032008, 0G0FT4G-VERS.032008, 0G0FT5G-VERS.032008, 0G0FT7G, 0G1BR3G, 12WFA6E, 12WFA6G, 12WFAAA, 12WFAAE, 12WFAAG, 12WFAAN, 190BM2G, 190FT15G, 190FT1G, 190FT2G, 190FT3G, 190FT42G, 190FT4G, 190FT6G, 190FT72G, 190FT7G, 190GRG, 191BR1G, 191BR1GA, 191BR2G, 191BR2GA, 1G0FR6G, 1G0FT1G-VERS.032008, 1G0FT2G-VERS.032008, 1G0FT3G-VERS.032008, 1G0FT4G-VERS.032008, 1G0FT6E, 1G0FT6G-VERS.032008, 1G0FT7G... (Otros modelos se puede ver en la tienda web)		





1

código	102989	referencia	35Z7400
descripción	tubo piloto tubo ø 5mm L 130mm		
Para modelos:	030, 031, 032, 31, 31GE, 31TC, 32, 32TC, 32TP, 32TPV, 32V		

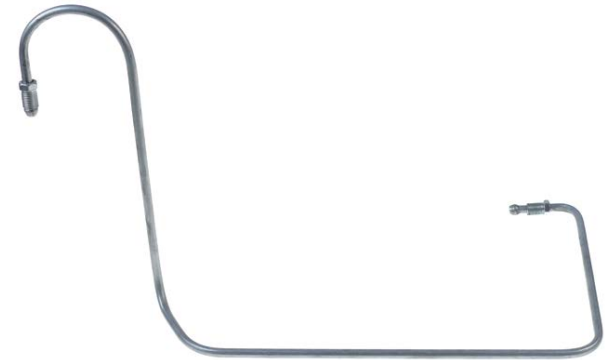

1

código	102988	referencia	35Z7410
descripción	tubo piloto tubo ø 5mm L 400mm		



1

código	102296	referencia	35X4590
descripción	tubo piloto tubo ø 6mm G1: M10 G2: M10		
Para modelos:	FC101, FC61, FCV101, FCV101-CSA, FCV101DM, FCV101DM-CSA, FCV101DS, FCV101DS-CSA, FCV61, FCV61-CSA, FCV61DM, FCV61DM-CSA, FCV61DS, FCV61DS-CSA		

consumibles

piedras volcánicas/briquetas de cerámicas



1

código	211049	referencia	37T1320
descripción	briquetas de cerámica medida 50x50x26mm UE 40 piezas (2,4kg)		
Para modelos:	08WGRCV, 090GRG, 0A0GRG, 0D0GRG, 190GRG, 1A0GRG, 1D0GRG, 1G0GRG, 6042120-08WGRCV		

componentes específicos

para cortadoras de fiambre

manillas de ajuste



1

código	697796	referencia	36M3680
descripción	manilla de ajuste ø 68mm eje ø 18mm eje L 73mm asidero ø 68mm sentido de rotación izquierdo		

excéntricas para espesor de corte



1

código	697508	referencia	3FL0209
descripción	excéntrica para grosor de corte agujero ø 18mm ancho de estría 8mm ø ext. 85mm espesor 24.5mm		

protección de mano



1

código	698212	referencia	35Q9820
descripción	protección de mano		
Para modelos:	AFT30MS, AFT30S, AFT33MS, AFT33S, AFT35		



cuchillas circulares

estándar



1

código	697463	referencia	36G8610
descripción	cuchilla circular ø ext. 350mm soporte ø 57mm 4 orificios int.ø 280mm H 22.5mm 100Cr6 estándar		
Para modelos:	AFC35, AFT35, AFT35VS		

piedras de afilar

pares de fresas



1

código	698340	referencia	36G3950
descripción	par de fresas 1 par		
Para modelos:	AFC35, AFT33MS, AFT33S, AFT35, AFT35VS		



1

código	699007	referencia	36G1030
descripción	piedra de afilar 1 par		

para sierras de cinta

cintas de sierras

ancho 16mm



1

código	699003	referencia	LF152020U16
descripción	cinta de sierras L 2020mm An 16mm espesor 0.5mm distancia entre dientes 6mm		

para trituradoras de carne

ruedas dentadas



1

código	698205	referencia	36G0390
descripción	rueda dentada doble ø 32/70mm soporte de eje ø 15mm An 30mm dientes 18/41 división ancho de diente 14. Novmm DIN/ISO Mod.12-22		

por cúter

árboles de accionamiento



1

código	694061	referencia	36G7000
descripción	árbol de accionamiento ø 22mm acero inoxidable L 137mm CL3		
Para modelos:	Q3, Q3M		

tapa



1

código	698209	referencia	6000920
descripción	tapa completo ø 215mm int.ø 210mm con imán Q 3-5-8		
Para modelos:	Q3, Q3M, Q5, Q52, Q5M, Q8, Q82		



1

código	694243	referencia	36Z0665
descripción	tapa ø 215mm int.ø 210mm plástico con imán CL 3-5-8		



1

código	691664	referencia	3031610
descripción	tapa para cutter ø 225mm int.ø 204mm plástico con junta C4-C6 edición desde 08/2003		
Para modelos:	SC4, SC6		



cuchillas

anillos distanciadores



código	697106	referencia	36G0650
descripción	anillo distanciador ø ext. 63mm ø int. 1 39mm distancia de sujeción 52mm agujero ø 5.5mm plástico CL 3-5-8		
Para modelos:	Q5, Q52, Q5M, Q8, Q82		

soportes



código	651037	referencia	36G7010
descripción	soporte cuchilla ø ext. 63mm ø int. 1 39mm ø int. 2 10mm H 81.5mm distancia de sujeción 52mm rosca M5 plástico CL 3-5-8		
Para modelos:	Q3, Q3M, Q5, Q52, Q5M, Q8, Q82		

cuchillas

cuchillas lisas



código	696177	referencia	3017950
descripción	cuchillo pos. de montaje abajo L 93mm soporte ø 33mm distancia de sujeción 46mm 4 orificios agujero ø 4.4mm espesor 2mm modelo C4-C6		
Para modelos:	SC4, SC6		



código	696173	referencia	36G7030
descripción	cuchillo pos. de montaje arriba soporte ø 42mm distancia de sujeción 52mm agujero ø 5.5mm espesor 2mm modelo CL 3-5-8		
Para modelos:	Q3, Q3M, Q5, Q52, Q5M, Q8, Q82		

para cortaverduras

discos expulsores



código	699011	referencia	36G6960
descripción	disco expulsor H 7mm ø 195mm alojamiento del eje 22x27mm		
Para modelos:	TV1, TV1M, TV2L		

otros



código	692145	referencia	36G6600
descripción	polea ø arandela 157mm ancho arandela 31mm soporte de eje ø 15mm anchura total 30mm plástico para peladora de patatas		
Para modelos:	LCV, P10, P102, P10M, P20, P202, P5, TV1, TV1M, TV2L		

para peladoras de patatas

árboles de accionamiento



código	692147	referencia	36G6590
descripción	árbol de accionamiento para peladora de patatas L 134mm		
Para modelos:	P10, P102, P10M, P20, P202, P5		

tapa



código	696454	referencia	36Z6501
descripción	tapa para peladora de patatas ø 430mm int. ø 380mm plástico distancia de sujeción 220mm H 80mm		
Para modelos:	LCV, P10, P102, P10M, P20, P202, P5		

accesorios para	696454		
código	901522	referencia	—
descripción	junta de tapa para FIMAR para peladora de patatas L 1280mm altura exterior 12mm An exterior 12mm		

abrasivos laterales

discos abrasivos



1

código	696769	referencia	3030900
descripción	disco pelador ø 383mm para peladora de patatas C565		
Para modelos:	MPK10, MPK10I, PK10, PK10I		

otros



1

código	696406	referencia	3190830
descripción	arandela para peladora de patatas ø ext. 42mm int.ø 28.7mm espesor 4.5mm		
Para modelos:	LCV, P10, P102, P10M, P20, P202, P5		



1

código	696408	referencia	36G5950
descripción	casquillo para peladora de patatas ø ext. 20mm int.ø 16mm espesor 2mm L 19.4mm		
Para modelos:	LCV, P10, P102, P10M, P20, P202, P5		



1

código	696407	referencia	36D9660
descripción	deflector para peladora de patatas plástico L 144mm An 38mm H 130mm rosca 1/4"/M6		
Para modelos:	P10, P102, P10M, P20, P202		

COMPONENTES ESPECÍFICOS ANGELO-PO



1

código	696412	referencia	3600870
descripción	fondo plástico		
Para modelos:	P10, P102, P10M, P20, P202, P5		

para batidoras amasadoras planetarias

batidores



1

código	699393	referencia	KA/W10731415
descripción	batidor soporte de eje ø 12.7mm H 185mm apto para KitchenAid		

para frigoríficos

recambios y accesorios



1

código	691195	referencia	36G5250
descripción	soporte para cremallera plástico		
Para modelos:	135, 135BX, 135CPX, SP135, SP135B, SP135BN, SP135CP, SP135NN, SP65, SP65B, SP65NB		

otros





1

código	690689	referencia	35X3460
descripción	anillo distnciador		
Para modelos:	40EV, 40EVP, 40PV, 40XPV		



			
1			
código	690691	referencia	36C2440
descripción	anillo distnciador		
Para modelos:	40EV, 40EVP, 40PV, 40XPV		

			
1			
código	695580	referencia	36D1250
descripción	marco L 1528mm An 55mm		
Para modelos:	120, 120B, 120PV, 135, 135-4, 135A, 135B, 135BA, 135BX, 135BXE, 135BXR, 135CPX, 135PVX, 135X, 135X-3, 135X-4, 135XE, 135XR, SP120, SP120B, SP135, SP135B, SP135CP		

			
1			
código	695581	referencia	36D1290
descripción	marco L 1639mm An 55mm		
Para modelos:	120, 120B, 120NN, 120PV, 135, 135-4, 135A, 135B, 135BA, 135BN, 135BNX, 135BX, 135BXE, 135BXR, 135CPX, 135NN, 135NNX, 135PVX, 135X, 135X-3, 135X-4, 135XE, 135XR, 55, 55B, 55PV, 65, 65A, 65B, 65BA, 65BX, 65BX-2, 65BXE, 65BXR, 65NB, 65NBX, 65NN, 65NNX, 65PVX, 65X, 65X-2, 65XE, 65XR, SP120, SP120B, SP120BN, SP120NN, SP135, SP135B, SP135BN...(Otros modelos se puede ver en la tienda web)		

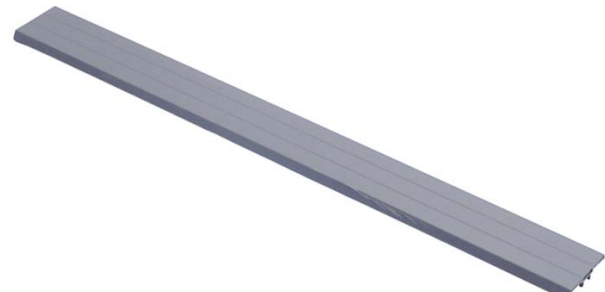
			
1			
código	695579	referencia	36D1260
descripción	marco L 621mm An 55mm		
Para modelos:	135-4, 135CPX, 135X-3, 135X-4, 65BX-2, 65NB, 65NBX, 65NN, 65NNX, 65X-2, SP135CP, SP65NB, SP65NN		

			
1			
código	698476	referencia	36E3990
descripción	purgador de condensados An 55mm H 45mm para frigorífico D1 ø 22mm D2 ø 16mm		
Para modelos:	6EA, 6EA11, 6EA11A, 6EA11M, 6EA13, 6EA13A, 6EA13M, 6EA2, 6EA2A, 6EA2M, 6EA, 6EAB, 6EABA, 6EABM, 6EAM, 6EB, 6EB11, 6EB11A, 6EB11M, 6EB13, 6EB13A, 6EB13M, 6EB2, 6EB22, 6EB22A, 6EB22M, 6EB2A, 6EB2M, 6EB4, 6EB4A, 6EB4M, 6EBA, 6EBB, 6EBBA, 6EBBM, 6EBM, 6EC, 6EC11, 6EC11A, 6EC11M, 6EC13, 6EC13A, 6EC13M, 6EC2, 6EC22, 6EC22A, 6EC22M, 6EC2A, 6EC2M, 6EC4...(Otros modelos se puede ver en la tienda web)		

			
1			
código	694636	referencia	33Q6300
descripción	tubo flexible int.ø 21mm ø ext. 27mm L 66mm ø 40mm grosor de la pared 3.5mm		
Para modelos:	AF2B, AF2B-OPR01, AF2N, AF2N-OPR01, PGA20, PGA30, PGA40, PGA60, PGA80, PGW20, PGW30, PGW40, PGW60, PGW80, SM4SR		

para mesas frías

cojinetes para tapas

			
1			
código	691099	referencia	35G4630
descripción	bisagra para tapa pos. de montaje izquierdo		
Para modelos:	SA87		



para máquina de hielo en cubitos

conductos hielo

mallas antideslizantes



código	694145	referencia	3020430
descripción	malla antideslizante para máquina de hielo en cubitos L 250mm An 170mm H 25mm		
Para modelos:	PG22C, PG23CW		

uniones roscadas

reducciones



código	520700	referencia	33Q5650
descripción	reducción rosca 3/4" H - 1/2" M latón		
Para modelos:	FCV101, FCV101-CSA, FCV101DM, FCV101DM-CSA, FCV101DS, FCV101DS-CSA, FCV101E, FCV101EDM, FCV101EDM-UL, FCV101EDS, FCV101EDS-UL, FCV101E-UL, FCV141, FCV141-CSA, FCV141DM, FCV141DM-CSA, FCV141DS, FCV141DS-CSA, FCV141E, FCV141EDM, FCV141EDS, FCV241, FCV241DM, FCV241DS, FCV241E, FCV241EDM, FCV241EDM-UL, FCV241EDS, FCV241EDS-UL, FCV241E-UL, FCV241G, FCV241G-CSA, FCV241GDM, FCV241GDM-CSA, FCV241GDS, FCV241GDS-CSA, FCV3EM, FCV401DM, FCV401DM-CSA, FCV401EDM, FCV401EDM-UL, FCV4E, FCV4EDS, FCV4EM, FCV61, FCV61-CSA, FCV61DM, FCV61DM-CSA, FCV61DS, FCV61DS-CSA...(Otros modelos se puede ver en la tienda web)		

tubos flexibles

otros

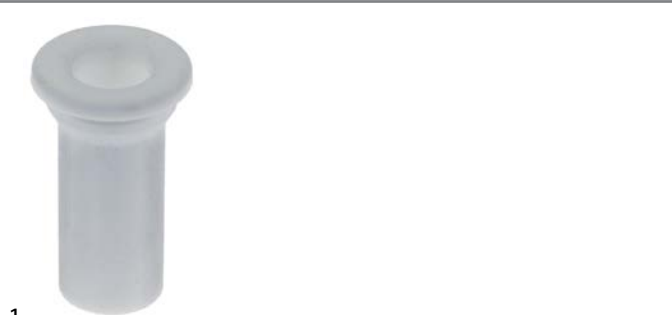

código	694636	referencia	33Q6300
descripción	tubo flexible int.ø 21mm ø ext. 27mm L 66mm ø 40mm grosor de la pared 3.5mm		
Para modelos:	AF2B, AF2B-OPR01, AF2N, AF2N-OPR01, PGA20, PGA30, PGA40, PGA60, PGA80, PGW20, PGW30, PGW40, PGW60, PGW80, SM4SR		

para baño-maría

cajas y paneles frontales

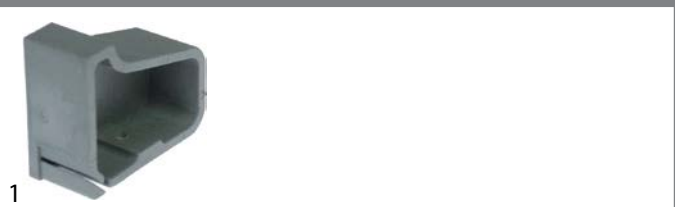

código	691184	referencia	36D3420
descripción	tapa terminal para panel de manejo pos. de montaje derecho		
Para modelos:	030, 030BME, 030E, 030EBM, 030FE, 030FE1, 030FE1B, 030FT, 030FTE, 030FTER, 030FTR, 031, 031BME, 031E, 031EBM, 031FT, 031FT04, 031FT06, 031FTE, 031FTE04, 031FTE06, 031FTER, 031FTERL, 031FTR, 031FTRL, 031TP, 032, 070BM, 070BME, 070D, 070DGG, 070E, 070FT, 070FT04, 070FT05, 070FTE, 070FTE04, 070FTE05, 070FTER, 070FTR, 0712D, 0712VA, 071BM, 071BME, 071D, 071DGG, 071E, 071FT, 071FT04, 071FT06...(Otros modelos se puede ver en la tienda web)		

para máquinas de espresso

unidades de infusión

juntas pra portafiltro

juntas tóricas



código	510409	referencia	3150430 3151960 37Q5260
descripción	junta tórica EPDM espesor 5.34mm int.ø 56.52mm UE 1 pzs		
Para modelos:	091CP1E, 0A1CP1E, 0G1CP1E, 0G1CP1EC, 0G1CP1E-VERS.2004, 191PI2E, 191PI2EA, 1A1PI2E, 1A1PI2EA, 1D1PI2E, 1D1PI2EA, 1G1PI1E, 30CPSE, 31PIE6, 6040090, 6040310, 6043850, 6043980, 70CPE, 71PIE15, 71PIE15A, 90CPE, 91PIE15, 91PIE15A, F60P, F60PR, F60T, F80P, F80PR, KD100, KD100A, KD100PSD, KD130, KD130A, KD130E, KD130EAT, KD60, KD60E, KD60EAT, KD60M, KD60MA, KD60ME, KD60MPS, KD60MPSA, KD60PS, KD60PSD, KD6EATSD, KD85, KD85A, KD85E...(Otros modelos se puede ver en la tienda web)		

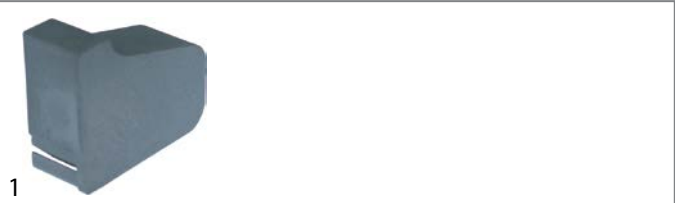

código	691183	referencia	36D3430
descripción	tapa terminal para panel de manejo pos. de montaje izquierdo		
Para modelos:	030, 030BME, 030E, 030EBM, 030FE, 030FE1, 030FE1B, 030FT, 030FTE, 030FTER, 030FTR, 031, 031BME, 031E, 031EBM, 031FT, 031FT04, 031FT06, 031FTE, 031FTE04, 031FTE06, 031FTER, 031FTERL, 031FTR, 031FTRL, 031TP, 032, 070BM, 070BME, 070D, 070DGG, 070E, 070FT, 070FT04, 070FT05, 070FTE, 070FTE04, 070FTE05, 070FTER, 070FTR, 0712D, 0712VA, 071BM, 071BME, 071D, 071DGG, 071E, 071FT, 071FT04, 071FT06...(Otros modelos se puede ver en la tienda web)		



para freidoras

cajas y paneles frontales



código	691184	referencia	36D3420
descripción	tapa terminal para panel de manejo pos. de montaje derecho		
Para modelos:	030, 030BME, 030E, 030EBM, 030FE, 030FE1, 030FE1B, 030FT, 030FTE, 030FTE1, 030FTR, 031, 031BME, 031E, 031EBM, 031FT, 031FT04, 031FT06, 031FTE, 031FTE04, 031FTE06, 031FTE1, 031FTE1L, 031FTR, 031FTRL, 031TP, 032, 070BM, 070BME, 070D, 070DGG, 070E, 070FT, 070FT04, 070FT05, 070FTE, 070FTE04, 070FTE05, 070FTE1, 070FTR, 0712D, 0712VA, 071BM, 071BME, 071D, 071DGG, 071E, 071FT, 071FT04, 071FT06...(Otros modelos se puede ver en la tienda web)		

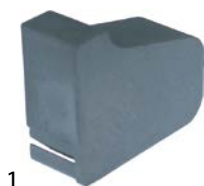

código	691183	referencia	36D3430
descripción	tapa terminal para panel de manejo pos. de montaje izquierdo		
Para modelos:	030, 030BME, 030E, 030EBM, 030FE, 030FE1, 030FE1B, 030FT, 030FTE, 030FTE1, 030FTR, 031, 031BME, 031E, 031EBM, 031FT, 031FT04, 031FT06, 031FTE, 031FTE04, 031FTE06, 031FTE1, 031FTE1L, 031FTR, 031FTRL, 031TP, 032, 070BM, 070BME, 070D, 070DGG, 070E, 070FT, 070FT04, 070FT05, 070FTE, 070FTE04, 070FTE05, 070FTE1, 070FTR, 0712D, 0712VA, 071BM, 071BME, 071D, 071DGG, 071E, 071FT, 071FT04, 071FT06...(Otros modelos se puede ver en la tienda web)		

vidrios



código	693397	referencia	3070970 37N1420
descripción	vidrio L 29mm An 29mm espesor 3.5mm cuadrado		
Para modelos:	06WCP1GM, 08WCP1GM, 08WFT1GV, 08WFT2GV, 08WFT3GV, 08WFT4GV, 08WFT6GV, 08WFT7GV, 090FT1G, 090FT2G, 090FT4G, 090FT5G, 090FT7G, 091CP1G, 091FR7G, 091FR7GS, 091FR7G-VERS.052012, 091FR7GX, 0A0FT1G, 0A0FT2G, 0A0FT4G, 0A0FT5G, 0A1CP1G, 0B0FT1G, 0B0FT2G, 0B0FT4G, 0B0FT5G, 0B1CP1G, 0D0FT1G, 0D0FT2G, 0D0FT4G, 0D0FT5G, 0D1CP1G, 0G0FT1G, 0G0FT1G-VERS.032008, 0G0FT2G, 0G0FT2G-VERS.032008, 0G0FT4G, 0G0FT4G-VERS.032008, 0G0FT5G, 0G0FT5G-VERS.032008, 0G0FT7G, 0G1CP1G, 0G1CP1G-VERS.2004, 0G1FR7G, 10CP1GA, 10CP1IA, 10WTPGE, 10WTPGV, 12CP1GA...(Otros modelos se puede ver en la tienda web)		

otros



código	691164	referencia	36D6960
descripción	barra para distanciador L 180mm rosca M6x1		
Para modelos:	030FE1, 030FE1B, 091FE28, 091FE28B, 30FES2, 30FES2B, 70FES2, 70FES2B		



código	691163	referencia	36D6950
descripción	barra para distanciador L 270mm rosca M6x1		
Para modelos:	70FE1, 70FE1B, 71FE2, 71FE2B		



código	691121	referencia	36D7150
descripción	estribo de retención para resistencia		
Para modelos:	030FE1, 030FE1B, 091FE28, 091FE28B, 30FES2, 30FES2B, 70FES2, 70FES2B		



código	541506	referencia	33Q5730
descripción	unión roscada completo rosca 1"		
Para modelos:	30CPS, 30CPSE, 70CP, 70CPE, 71CP, 71CP2, 90CP, 90CPE, 91CP		

para grills



código	690425	referencia	3600770
descripción	placa de asiento L 105mm An 35mm H 7mm dist. del agujero 76mm agujero ø 12mm		
Para modelos:	120, 120B, 120NN, 120PV, 135, 135-4, 135A, 135B, 135BA, 135BN, 135BNX, 135BX, 135BXE, 135BXR, 135CPX, 135NN, 135NNX, 135PVX, 135X, 135X-3, 135X-4, 135XE, 135XR, 55, 55B, 55PV, 65, 65A, 65B, 65BA, 65BX, 65BX-2, 65BXE, 65BXR, 65NB, 65NBX, 65NN, 65NNX, 65PVX, 65X, 65X-2, 65XE, 65XR, ART1LD, ART1LDA, ART2LD, ART2SD, ART3SD, S125, S125-4...(Otros modelos se puede ver en la tienda web)		

para planchas grill

recambios y accesorios



1			
código	691169	referencia	35T2260
descripción	gancho para placa radiante		
Para modelos:	031TP, 071TP, 091TP, 31TP, 32TP, 32TPV, 71TP, 72TP, 72TPGG		



1			
código	693000	referencia	35Y2780
descripción	resorte para parrilla de piedra volcánica		
Para modelos:	08WGRGV, 090GRG, 0A0GRG, 0D0GRG, 190GRG, 1A0GRG, 1D0GRG, 1G0GRG		

cajas y paneles frontales



1			
código	691184	referencia	36D3420
descripción	tapa terminal para panel de manejo pos. de montaje derecho		
Para modelos:	030, 030BME, 030E, 030EBM, 030FE, 030FE1, 030FE1B, 030FT, 030FTE, 030FTR, 030FTR, 031, 031BME, 031E, 031EBM, 031FT, 031FT04, 031FT06, 031FTE, 031FTE04, 031FTE06, 031FTR, 031FTR, 031FTRL, 031TP, 032, 070BM, 070BME, 070D, 070DGG, 070E, 070FT, 070FT04, 070FT05, 070FTE, 070FTE04, 070FTE05, 070FTR, 070FTR, 0712D, 0712VA, 071BM, 071BME, 071D, 071DGG, 071E, 071FT, 071FT04, 071FT06...(Otros modelos se puede ver en la tienda web)		

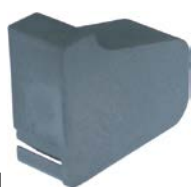

1			
código	691183	referencia	36D3430
descripción	tapa terminal para panel de manejo pos. de montaje izquierdo		
Para modelos:	030, 030BME, 030E, 030EBM, 030FE, 030FE1, 030FE1B, 030FT, 030FTE, 030FTR, 030FTR, 031, 031BME, 031E, 031EBM, 031FT, 031FT04, 031FT06, 031FTE, 031FTE04, 031FTE06, 031FTR, 031FTRL, 031TP, 032, 070BM, 070BME, 070D, 070DGG, 070E, 070FT, 070FT04, 070FT05, 070FTE, 070FTE04, 070FTE05, 070FTR, 070FTR, 0712D, 0712VA, 071BM, 071BME, 071D, 071DGG, 071E, 071FT, 071FT04, 071FT06...(Otros modelos se puede ver en la tienda web)		

cubetas



1			
código	691207	referencia	35N2250
descripción	bandeja colectora de grasa L 540mm An 32mm H 15mm		
Para modelos:	0A0FT1E, 0A0FT1G, 0A0FT2E, 0A0FT2G, 0A0FT4E, 0A0FT4G, 0A0FT5E, 0A0FT5G, 0B0FT1G, 0B0FT2G, 0B0FT4G, 0B0FT5G, 0D0FT1E, 0D0FT1G, 0D0FT2E, 0D0FT2G, 0D0FT4E, 0D0FT4G, 0D0FT5E, 0D0FT5G, 0G0FT1E, 0G0FT1G, 0G0FT1G-VERS.032008, 0G0FT2E, 0G0FT2G, 0G0FT2G-VERS.032008, 0G0FT4E, 0G0FT4G, 0G0FT4G-VERS.032008, 0G0FT5E, 0G0FT5G, 0G0FT5G-VERS.032008, 0G0FT7E, 0G0FT7G		

tapón de salida



1			
código	691190	referencia	3062770 3115040 36C0360
descripción	tapón de desagüe PTFE L 52mm D1 ø 40mm D2 ø 33mm D3 ø 28mm		
Para modelos:	031FT04, 031FT06, 031FTE04, 031FTE06, 06WFT1EV, 06WFT2EV, 06WFT3EV, 06WFT4EV, 06WFT6EV, 06WFT7EV, 070FT04, 070FT05, 070FTE04, 070FTE05, 071FT04, 071FT06, 071FTE04, 071FTE06, 08WFT1EV, 08WFT1GV, 08WFT2EV, 08WFT2GV, 08WFT3EV, 08WFT-3GV, 08WFT4EV, 08WFT4GV, 08WFT6EV, 08WFT6GV, 08WFT7EV, 08WFT7GV, 08WGREV, 090FT04, 090FT05, 090FT1E, 090FT1G, 090FT2E, 090FT2G, 090FT4E, 090FT4G, 090FT5E, 090FT5G, 090FT7E, 090FT7G, 090FTE04, 090FTE05, 091FT04, 091FT06, 091FT1E, 091FT2E, 091FT5E...(Otros modelos se puede ver en la tienda web)		



para hornos a convección/combinados

válvulas de desagüe



1

código	696773	referencia	6300833
descripción	pileta de desagüe juego para horno a vapor combinado tubo ø 8mm		
Para modelos:	FX101E3, FX101E3C, FX101E3C-VERS.022014, FX101E3R, FX101E3R-VERS.022014, FX101E3-VERS.022014, FX101G3, FX101G3C, FX101G3C-VERS.022014, FX101G3R, FX101G3R-VERS.022014, FX101G3-VERS.022014, FX10E3CR, FX10E3CR-VERS.022014, FX10G3CR, FX10G3CR-VERS.022014, FX122E3, FX122E3C, FX122E3T, FX122E3T-VERS.022014, FX122G3, FX122G3C, FX122G3T, FX122G3T-VERS.022014, FX12E3CT, FX12E3CT-VERS.022014, FX12G3CT, FX12G3CT-VERS.022014, FX201E3, FX201E3P, FX201E3P-VERS.022014, FX201E3-VERS.022014, FX201G3P, FX201G3-VERS.022014, FX202E3, FX202E3-230V-3-50Hz-60Hz, FX202E3-230V-3-50Hz-60Hz-VERS.022014, FX202E3-VERS.022014, FX202G3, FX202G3-VERS.022014, FX61E3, FX61E3C, FX61E3CR, FX61E3CR-VERS.022014, FX61E3C-VERS.022014, FX61E3R, FX61E3R-VERS.022014, FX61E3-VERS.022014, FX61G3, FX61G3C...(Otros modelos se puede ver en la tienda web)		



2

código	696790	referencia	30Z3011
descripción	tubo de desagüe rosca 1 1/2" H acodado 90° plástico int.ø 37mm ø ext. 40mm para horno a vapor combinado		
Para modelos:	FC1011E, FC1011G, FC1221E, FC1221G, FC611E, FC611G, FM1011E1-VERS.2006, FM1011E2-VERS.2006, FM1011E3-VERS.2006, FM1011G1-VERS.2006, FM1011G2-VERS.2006, FM1011G3-VERS.2006, FM1221E1-VERS.2006, FM1221E2-VERS.2006, FM1221E3-VERS.2006, FM1221G1-VERS.2006, FM1221G2-VERS.2006, FM1221G3-VERS.2006, FM2011E2-VERS.2006, FM2011E3-VERS.2006, FM2011G2-VERS.2006, FM2011G3-VERS.2006, FM2021E2-VERS.2006, FM2021E3-VERS.2006, FM2021G2-VERS.2006, FM2021G3-VERS.2006, FM611E1-VERS.2006, FM611E2-VERS.2006, FM611E3-VERS.2006, FM611G1-VERS.2006, FM611G2-VERS.2006, FM611G3-VERS.2006, FM721E1-VERS.2006, FM721E2-VERS.2006, FM721E3-VERS.2006, FM721G1-VERS.2006, FM721G2-VERS.2006, FM721G3-VERS.2006		



1

código	696788	referencia	3120620 3215240
descripción	tubo de desagüe rosca 1 1/2" H pieza T plástico int.ø 37mm ø ext. 40mm para horno a vapor combinado		
Para modelos:	BX101E, BX101E-VERS.122013, BX101G, BX101G-VERS.122013, BX61E, BX61E-VERS.122013, BX61G, BX61G-VERS.122013, FX101E1, FX101E1R, FX101E2, FX101E2C, FX101E2C-VERS.032014, FX101E2R, FX101E2R-VERS.032014, FX101E2-VERS.032014, FX101E3, FX101E3C, FX101E3C-VERS.022014, FX101E3R, FX101E3R-VERS.022014, FX101E3-VERS.022014, FX101G1, FX101G1R, FX101G2, FX101G2C, FX101G2C-VERS.032014, FX101G2R, FX101G2R-VERS.032014, FX101G2-VERS.032014, FX101G3, FX101G3C, FX101G3C-VERS.022014, FX101G3R, FX101G3R-VERS.022014, FX101G3-VERS.022014, FX10E2CR, FX10E2CR-VERS.032014, FX10E3CR, FX10E3CR-VERS.022014, FX10G2CR, FX10G2CR-VERS.032014, FX10G3CR, FX10G3CR-VERS.022014, FX61E1, FX61E1R, FX61E2, FX61E2C, FX61E2CR, FX61E2CR-VERS.032014...(Otros modelos se puede ver en la tienda web)		



1

código	692880	referencia	36A3400 36A3401
descripción	casquillo int.ø 34mm ø ext. 60mm L 20mm rosca 1 1/4" M		
Para modelos:	BX101E, BX101E-VERS.122013, BX101G, BX101G-VERS.122013, BX122E, BX122E-VERS.122013, BX122G, BX122G-VERS.122013, BX61E, BX61E-VERS.122013, BX61G, BX61G-VERS.122013, BX82E, BX82E-VERS.122013, BX82G, BX82G-VERS.122013, FC101, FC1011E, FC1011G, FC101E, FC1221E, FC1221G, FC241, FC241E, FC241G, FC61, FC611E, FC611G, FC61E, FCV101, FCV101-CSA, FCV101DM, FCV101DM-CSA, FCV101DS, FCV101DS-CSA, FCV101E, FCV101EDM, FCV101EDM-UL, FCV101EDS, FCV101EDS-UL, FCV101E-UL, FCV141, FCV141-CSA, FCV141DM, FCV141DM-CSA, FCV141DS, FCV141DS-CSA, FCV141E, FCV141EDM, FCV141EDS...(Otros modelos se puede ver en la tienda web)		



tuberías de vapor



1

código	540906	referencia	33Q5980
descripción	boquilla de vapor plástico L 78.5mm int.ø 12.5mm ø ext. 40mm		
Para modelos:	FC101, FC101E, FC101G, FC101E, FC1221E, FC1221G, FC241, FC241E, FC241G, FC61, FC61E, FC61G, FC61E, FCV101, FCV101-CSA, FCV101DM, FCV101DM-CSA, FCV101DS, FCV101DS-CSA, FCV101E, FCV101EDM, FCV101EDM-UL, FCV101EDS, FCV101EDS-UL, FCV101E-UL, FCV141, FCV141-CSA, FCV141DM, FCV141DM-CSA, FCV141DS, FCV141DS-CSA, FCV141E, FCV141EDM, FCV141EDS, FCV241, FCV241DM, FCV241DS, FCV241E, FCV241EDM, FCV241EDM-UL, FCV241EDS, FCV241EDS-UL, FCV241E-UL, FCV241G, FCV241G-CSA, FCV241GDM, FCV241GDM-CSA, FCV241GDS, FCV241GDS-CSA, FCV61...(Otros modelos se puede ver en la tienda web)		
accesorios para	541509		



2

código	691639	referencia	33Q6230
descripción	casquillo acero inoxidable L 31mm int.ø 33mm ø ext. 35mm		
Para modelos:	FC101, FC241, FC241G, FC61, FCV101, FCV101-CSA, FCV101DM, FCV101DM-CSA, FCV101DS, FCV101DS-CSA, FCV141, FCV141-CSA, FCV141DM, FCV141DM-CSA, FCV141DS, FCV141DS-CSA, FCV241, FCV241DM, FCV241DS, FCV241G, FCV241G-CSA, FCV241GDM, FCV241GDM-CSA, FCV241GDS, FCV241GDS-CSA, FCV401DM, FCV401DM-CSA, FCV61, FCV61-CSA, FCV61DM, FCV61DM-CSA, FCV61DS, FCV61DS-CSA		

boquillas de inyección





1

código	541507	referencia	33T4110
descripción	boquilla refrigeración rosca 1/8"		
Para modelos:	FCV3EM, FCV4E, FCV4EDS, FCV4EM, FM423E1, FM423E2		
accesorios para	541507		
	código	541488	referencia 33Q5591 33Q5592
	empalme de tubo rosca M14x1 M - 1/8" F acodado		



1

código	541509	referencia	33T3720
descripción	boquilla refrigeración rosca 1/8"		
Para modelos:	FC101, FC101E, FC241, FC241E, FC241G, FC61, FC61E, FCV101, FCV101-CSA, FCV101DM, FCV101DM-CSA, FCV101DS, FCV101DS-CSA, FCV101E, FCV101EDM, FCV101EDM-UL, FCV101EDS, FCV101EDS-UL, FCV101E-UL, FCV141, FCV141-CSA, FCV141DM, FCV141DM-CSA, FCV141DS, FCV141DS-CSA, FCV141E, FCV141EDM, FCV141EDS, FCV241, FCV241DM, FCV241DS, FCV241E, FCV241EDM, FCV241EDM-UL, FCV241EDS, FCV241EDS-UL, FCV241E-UL, FCV241G, FCV241G-CSA, FCV241GDM, FCV241GDM-CSA, FCV241GDS, FCV241GDS-CSA, FCV401DM, FCV401DM-CSA, FCV401EDM, FCV401EDM-UL, FCV61, FCV61-CSA, FCV61DM...(Otros modelos se puede ver en la tienda web)		
accesorios para	541509		
	código	541488	referencia 33Q5591 33Q5592
	empalme de tubo rosca M14x1 M - 1/8" F acodado		



1

código	542429	referencia	33T4450
descripción	boquilla taladro ø 5/3,65mm L 24mm EC 12 latón rosca M10x1		





1

código	692721	referencia	33Q5441 33Q5442
descripción	boquilla de inyección taladro ø 0.5mm D1 ø 12mm D2 ø 12mm L 60mm EC 17 latón para horno a vapor combinado rosca 1/8"		
Para modelos:	FC61, FC61E, FCV61, FCV61-CSA, FCV61DM, FCV61DM-CSA, FCV61DS, FCV61DS-CSA, FCV61E, FCV61EDM, FCV61EDM-UL, FCV61EDS, FCV61EDS-UL, FCV61E-UL, FM611E1, FM611E2, FM611E3, FM611G1, FM611G2, FM611G3		



1

código	541487	referencia	33Q5910 33Q5911
descripción	boquilla de inyección taladro ø 7/0,6mm D1 ø 12mm D2 ø 12mm L 60mm EC 17 latón para horno a vapor combinado rosca 1/8"		
Para modelos:	FC101, FC101E, FCV101, FCV101-CSA, FCV101DM, FCV101DM-CSA, FCV101DS, FCV101DS-CSA, FCV101E, FCV101EDM, FCV101EDM-UL, FCV101EDS, FCV101EDS-UL, FCV101E-UL, FCV401DM, FM1011E1, FM1011E2, FM1011E3, FM1011G1, FM1011G2, FM1011G3		
accesorios para	541487		
	código	541508	referencia 33D1680
	manómetro ø 40mm margen de presión 0-4bar empalme rosca 1/8"		

			
1			
código	542427	referencia	33Q6081
descripción	boquilla de inyección taladro \varnothing 7/0,7mm D1 \varnothing 12mm D2 \varnothing 12mm L 60mm EC 17 latón para horno a vapor combinado rosca 1/8"		
Para modelos:	FC241E, FC241G, FCV141, FCV141-CSA, FCV141DM, FCV141DM-CSA, FCV141DS, FCV141DS-CSA, FCV141E, FCV141EDM, FCV141EDS, FCV241E, FCV241EDM, FCV241EDM-UL, FCV241EDS, FCV241EDS-UL, FCV241E-UL, FCV241G, FCV241G-CSA, FCV241GDM, FCV241GDM-CSA, FCV241GDS, FCV241GDS-CSA, FCV401EDM, FCV401EDM-UL, FCV72EDM-UL, FCV72EDS-UL, FCV72E-UL, FM1221E1, FM1221E2, FM1221E3, FM1221G1, FM1221G2, FM1221G3, FM721E1, FM721E2, FM721E3, FM721G1, FM721G2, FM721G3		

			
1			
código	542425	referencia	33Q5920 33Q5921
descripción	boquilla de inyección taladro \varnothing 7/4,5mm D1 \varnothing 12mm D2 \varnothing 12mm L 60mm EC 17 latón para horno a vapor combinado rosca 1/8"		
Para modelos:	FC101, FC101E, FC241, FC241E, FC241G, FC61, FC61E, FCV101, FCV101-CSA, FCV101DM, FCV101DM-CSA, FCV101DS, FCV101DS-CSA, FCV101E, FCV101EDM, FCV101EDM-UL, FCV101EDS, FCV101EDS-UL, FCV101E-UL, FCV141, FCV141-CSA, FCV141DM, FCV141DM-CSA, FCV141DS, FCV141DS-CSA, FCV141E, FCV141EDM, FCV141EDS, FCV241, FCV241DM, FCV241DS, FCV241E, FCV241EDM, FCV241EDM-UL, FCV241EDS, FCV241EDS-UL, FCV241E-UL, FCV241G, FCV241G-CSA, FCV241GDM, FCV241GDM-CSA, FCV241GDS, FCV241GDS-CSA, FCV401DM, FCV401DM-CSA, FCV401EDM, FCV401EDM-UL, FCV61, FCV61-CSA, FCV61DM...(Otros modelos se puede ver en la tienda web)		

recambios y accesorios

			
1			
código	691167	referencia	36D9150
descripción	anillo int. \varnothing 26mm \varnothing ext. 30 espesor 1.5mm		

			
1			
código	691177	referencia	35S8650
descripción	anillo de sujeción para portalámparas		

			
1			
código	691742	referencia	3120030
descripción	arandela \varnothing ext. 30		
Para modelos:	FCV241G-CSA, FCV241GDM-CSA, FCV241GDS-CSA, L80		

			
1			
código	691192	referencia	36D0360
descripción	brida		

			
1			
código	691176	referencia	35T0080
descripción	chapa deflectora \varnothing 60mm		

			
1			
código	551445	referencia	3004791
descripción	distribuidor de agua para horno a vapor combinado chapa de acero cromado L 92mm \varnothing 35mm		
Para modelos:	FM1011E1, FM1011E1-VERS.2006, FM1011E2, FM1011E2-VERS.2006, FM1011E3, FM1011E3-VERS.2006, FM1011G1, FM1011G1-VERS.2006, FM1011G2, FM1011G2-VERS.2006, FM1011G3, FM1011G3-VERS.2006, FM1221E1, FM1221E1-VERS.2006, FM1221E2, FM1221E2-VERS.2006, FM1221E3, FM1221E3-VERS.2006, FM1221G1, FM1221G1-VERS.2006, FM1221G2, FM1221G2-VERS.2006, FM1221G3, FM1221G3-VERS.2006, FM2011E2-VERS.2006, FM2011E3-VERS.2006, FM2011G2-VERS.2006, FM2011G3-VERS.2006, FM2021E1, FM2021E2, FM2021E2-VERS.2006, FM2021E3, FM2021E3-VERS.2006, FM2021G1, FM2021G2, FM2021G2-VERS.2006, FM2021G3, FM2021G3-VERS.2006, FM611E1, FM611E1-VERS.2006, FM611E2, FM611E2-VERS.2006, FM611E3, FM611E3-VERS.2006, FM611G1, FM611G1-VERS.2006, FM611G2, FM611G2-VERS.2006, FM611G3, FM611G3-VERS.2006...(Otros modelos se puede ver en la tienda web)		

			
1			
código	696791	referencia	3011590 3253680
descripción	funda protectora para bujía L 80mm 7/9 goma		
Para modelos:	091FR11, 091FR11A, 091FR11D, 091FR11D-VERS.052012, 091FR11-VERS.032012, 091FR7G, 091FR7GS, 091FR7G-VERS.052012, 091FR7GX, 10CP11A, 12CP11A, 18CP21A, 191FR21, 191FR21D, 191FR21D-VERS.092012, 191FR21-VERS.032012, BX101G, BX122G, BX61G, BX82G, FC1011G, FC1221G, FC611G, FM1011G1, FM1011G1-VERS.2006, FM1011G2, FM1011G2-VERS.2006, FM1011G3, FM1011G3-VERS.2006, FM1221G1, FM1221G1-VERS.2006, FM1221G2, FM1221G2-VERS.2006, FM1221G3, FM1221G3-VERS.2006, FM2011G2-VERS.2006, FM2011G3-VERS.2006, FM2021G1, FM2021G2, FM2021G2-VERS.2006, FM2021G3, FM2021G3-VERS.2006, FM611G1, FM611G1-VERS.2006, FM611G2, FM611G2-VERS.2006, FM611G3, FM611G3-VERS.2006, FM721G1, FM721G1-VERS.2006...(Otros modelos se puede ver en la tienda web)		



			
código	691199	referencia	36G5380
descripción	guía contrapeso ø 37mm		
Para modelos:	FC101, FC101E, FC241, FC241E, FC241G, FC61, FC61E, FCV101, FCV101-CSA, FCV101DM, FCV101DM-CSA, FCV101DS, FCV101DS-CSA, FCV101E, FCV101EDM, FCV101EDM-UL, FCV101EDS, FCV101EDS-UL, FCV101E-UL, FCV141, FCV141-CSA, FCV141DM, FCV141DM-CSA, FCV141DS, FCV141DS-CSA, FCV141E, FCV141EDM, FCV141EDS, FCV241, FCV241DM, FCV241DS, FCV241E, FCV241EDM, FCV241EDM-UL, FCV241EDS, FCV241EDS-UL, FCV241E-UL, FCV241G, FCV241G-CSA, FCV241GDM, FCV241GDM-CSA, FCV241GDS, FCV241GDS-CSA, FCV61, FCV61-CSA, FCV61DM, FCV61DM-CSA, FCV61DS, FCV61DS-CSA, FCV61E...(Otros modelos se puede ver en la tienda web)		

			
código	691160	referencia	36G0060
descripción	guía de resorte		

			
código	521194	referencia	36E2350
descripción	junta para intercambiador térmico horno a vapor combinado int.ø 40mm dist. del agujero 52mm espesor 4mm		
Para modelos:	BX101G, BX101G-VERS.122013, BX61G, BX61G-VERS.122013, FC1011G, FM1011G1, FM1011G1-VERS.2006, FM1011G2, FM1011G2-VERS.2006, FM1011G3, FM1011G3-VERS.2006, FX101G1, FX101G1R, FX101G2, FX101G2C, FX101G2C-VERS.032014, FX101G2R, FX101G2R-VERS.032014, FX101G2-VERS.032014, FX101G3, FX101G3C, FX101G3C-VERS.022014, FX101G3R, FX101G3R-VERS.022014, FX101G3-VERS.022014, FX10G2CR, FX10G2CR-VERS.032014, FX10G3CR, FX10G3CR-VERS.022014, FX201G2, FX201G2P, FX201G2P-VERS.032014, FX201G2-VERS.032014, FX201G3P, FX201G3-VERS.022014, FX61G1, FX61G1R, FX61G2, FX61G2C, FX61G2CR, FX61G2CR-VERS.032014, FX61G2C-VERS.032014, FX61G2R, FX61G2R-VERS.032014, FX61G2-VERS.032014, FX61G3, FX61G3C, FX61G3CR, FX61G3CR-VERS.022014, FX61G3C-VERS.022014...(Otros modelos se puede ver en la tienda web)		

			
código	551446	referencia	3003760
descripción	pieza de empalme L 42mm EC 14 1/8" F - 1/8" M		
Para modelos:	FM1011E2-VERS.2006, FM1011E3, FM1011E3-VERS.2006, FM1011G2-VERS.2006, FM1011G3, FM1011G3-VERS.2006, FM1221E2-VERS.2006, FM1221E3, FM1221E3-VERS.2006, FM1221G2-VERS.2006, FM1221G3, FM1221G3-VERS.2006, FM2011E2-VERS.2006, FM2011E3-VERS.2006, FM2011G2-VERS.2006, FM2011G3-VERS.2006, FM2021E2-VERS.2006, FM2021E3, FM2021E3-VERS.2006, FM2021G2-VERS.2006, FM2021G3, FM2021G3-VERS.2006, FM611E2-VERS.2006, FM611E3, FM611E3-VERS.2006, FM611G2-VERS.2006, FM611G3, FM611G3-VERS.2006, FM721E2-VERS.2006, FM721E3, FM721E3-VERS.2006, FM721G2-VERS.2006, FM721G3, FM721G3-VERS.2006, FX201E3, FX201E3P, FX201E3P-VERS.022014, FX201E3-VERS.022014, FX201G3P, FX201G3-VERS.022014, FX202E3, FX202E3-230V-3-50Hz-60Hz, FX202E3-230V-3-50Hz-60Hz-VERS.022014, FX202E3-VERS.022014, FX202G3, FX202G3-VERS.022014		

			
código	552007	referencia	33Q5641
descripción	pieza de empalme L 48mm latón para horno a vapor combinado		
Para modelos:	FCV101, FCV101-CSA, FCV101DM, FCV101DM-CSA, FCV101DS, FCV101DS-CSA, FCV101E, FCV101EDM, FCV101EDM-UL, FCV101EDS, FCV101EDS-UL, FCV101E-UL, FCV141, FCV141-CSA, FCV141DM, FCV141DM-CSA, FCV141DS, FCV141DS-CSA, FCV141E, FCV141EDM, FCV141EDS, FCV241, FCV241DM, FCV241DS, FCV241E, FCV241EDM, FCV241EDM-UL, FCV241EDS, FCV241EDS-UL, FCV241E-UL, FCV241G, FCV241G-CSA, FCV241GDM, FCV241GDM-CSA, FCV241GDS, FCV241GDS-CSA, FCV3EM, FCV401DM, FCV401DM-CSA, FCV401EDM, FCV401EDM-UL, FCV4E, FCV4EDS, FCV4EM, FCV61, FCV61-CSA, FCV61DM, FCV61DM-CSA, FCV61DS, FCV61DS-CSA...(Otros modelos se puede ver en la tienda web)		

			
código	551447	referencia	3091170
descripción	pieza de empalme para horno a vapor combinado acero inoxidable L 162mm ø 10mm		

			
código	542426	referencia	3007200
descripción	pieza de empalme para horno a vapor combinado L 22mm ø 13.5mm EC 14 1/8" M - 1/8" H		
Para modelos:	FM1011E2-VERS.2006, FM1011E3, FM1011E3-VERS.2006, FM1011G2-VERS.2006, FM1011G3, FM1011G3-VERS.2006, FM1221E2-VERS.2006, FM1221E3, FM1221E3-VERS.2006, FM1221G2-VERS.2006, FM1221G3, FM1221G3-VERS.2006, FM2011E2-VERS.2006, FM2011E3-VERS.2006, FM2011G2-VERS.2006, FM2011G3-VERS.2006, FM2021E2-VERS.2006, FM2021E3, FM2021E3-VERS.2006, FM2021G2-VERS.2006, FM2021G3, FM2021G3-VERS.2006, FM423E2, FM611E2-VERS.2006, FM611E3, FM611E3-VERS.2006, FM611G2-VERS.2006, FM611G3, FM611G3-VERS.2006, FM721E2-VERS.2006, FM721E3, FM721E3-VERS.2006, FM721G2-VERS.2006, FM721G3, FM721G3-VERS.2006		

			
código	521197	referencia	36E4290
descripción	pieza Y rosca 1/8" H - 1/8" H - 1/8" H acero inoxidable EC 13		
Para modelos:	FM1011E3, FM1011G3, FM1221E3, FM1221G3, FM611E3, FM611G3, FM721E3, FM721G3		

			
1			
código	541495	referencia	33Q5630
descripción	reducción para horno de convección L 44mm EC 21 H 3/8" M M16x1,5		
Para modelos:	FC101, FC101E, FC241, FC241E, FC241G, FC61, FC61E, FCV101, FCV101-CSA, FCV101DM, FCV101DM-CSA, FCV101DS, FCV101DS-CSA, FCV101E, FCV101EDM, FCV101EDM-UL, FCV101EDS, FCV101EDS-UL, FCV101E-UL, FCV141, FCV141-CSA, FCV141DM, FCV141DM-CSA, FCV141DS, FCV141DS-CSA, FCV141E, FCV141EDM, FCV141EDS, FCV241, FCV241DM, FCV241DS, FCV241E, FCV241EDM, FCV241EDM-UL, FCV241EDS, FCV241EDS-UL, FCV241E-UL, FCV241G, FCV241G-CSA, FCV241GDM, FCV241GDM-CSA, FCV241GDS, FCV241GDS-CSA, FCV401DM, FCV401DM-CSA, FCV401EDM, FCV401EDM-UL, FCV61, FCV61-CSA, FCV61DM...(Otros modelos se puede ver en la tienda web)		

			
2			
código	691165	referencia	36G0190
descripción	rueda An 35mm ø 44mm		

			
1			
código	108153	referencia	6300748
descripción	soplador para quemador horno a vapor combinado 230V 65W dist. del agujero 50mm NRG118/0800-3612-030204		
Para modelos:	BX101G, BX101G-VERS.122013, BX122G, BX122G-VERS.122013, BX61G, BX61G-VERS.122013, BX82G, BX82G-VERS.122013, FX101G1, FX101G1R, FX101G2, FX101G2C, FX101G2C-VERS.032014, FX101G2R, FX101G2R-VERS.032014, FX101G2-VERS.032014, FX101G3, FX101G3C, FX101G3C-VERS.022014, FX101G3R, FX101G3R-VERS.022014, FX101G3-VERS.022014, FX10G2CR, FX10G2CR-VERS.032014, FX10G3CR, FX10G3CR-VERS.022014, FX122G1, FX122G2, FX122G2C, FX122G2T, FX122G2T-VERS.032014, FX122G3, FX122G3C, FX122G3T, FX122G3T-VERS.022014, FX12G3CT, FX12G3CT-VERS.022014, FX201G2, FX201G2P, FX201G2P-VERS.032014, FX201G2-VERS.032014, FX201G3P, FX201G3-VERS.022014, FX202G2, FX202G2-VERS.032014, FX202G3, FX202G3-VERS.022014, FX61G1, FX61G1R, FX61G2...(Otros modelos se puede ver en la tienda web)		

			
1			
código	541503	referencia	33Q0530
descripción	tapa terminal para horno de convección rosca 3/8"		
Para modelos:	FC1011E, FC1011G, FC1221E, FC1221G, FC611E, FC611G, FCV101DM, FCV101DM-CSA, FCV101DS, FCV101DS-CSA, FCV101EDM, FCV101EDM-UL, FCV101EDS, FCV101EDS-UL, FCV141DM, FCV141DM-CSA, FCV141DS, FCV141DS-CSA, FCV141EDM, FCV141EDS, FCV241DM, FCV241DS, FCV241EDM, FCV241EDM-UL, FCV241EDS, FCV241EDS-UL, FCV241GDM, FCV241GDM-CSA, FCV241GDS, FCV241GDS-CSA, FCV401DM, FCV401DM-CSA, FCV61DM, FCV61DM-CSA, FCV61DS, FCV61DS-CSA, FCV61EDM, FCV61EDM-UL, FCV61EDS, FCV61EDS-UL, FCV72EDM-UL, FCV72EDS-UL, FM1011E1-VERS.2006, FM1011E2, FM1011E3, FM1011G1-VERS.2006, FM1011G2, FM1011G3, FM1221E1-VERS.2006, FM1221G1-VERS.2006...(Otros modelos se puede ver en la tienda web)		

			
1			
código	541498	referencia	33Q5410
descripción	unión roscada EC 50 rosca 1/4" int. ø 31mm		
Para modelos:	FC101, FC101E, FC241, FC241E, FC241G, FC61, FC61E, FCV101, FCV101-CSA, FCV101DM, FCV101DM-CSA, FCV101DS, FCV101DS-CSA, FCV101E, FCV101EDM, FCV101EDM-UL, FCV101EDS, FCV101EDS-UL, FCV101E-UL, FCV141, FCV141-CSA, FCV141DM, FCV141DM-CSA, FCV141DS, FCV141DS-CSA, FCV141E, FCV141EDM, FCV141EDS, FCV241, FCV241DM, FCV241DS, FCV241E, FCV241EDM, FCV241EDM-UL, FCV241EDS, FCV241EDS-UL, FCV241E-UL, FCV241G, FCV241G-CSA, FCV241GDM, FCV241GDM-CSA, FCV241GDS, FCV241GDS-CSA, FCV401DM, FCV401DM-CSA, FCV401EDM, FCV401EDM-UL, FCV61, FCV61-CSA, FCV61DM, FCV61DM-CSA...(Otros modelos se puede ver en la tienda web)		
accesorios para	541498		
		código	541499
		referencia	3151450
	junta para ANGELO PO tamaño 1/4"		

vidrios			
			
1			
código	693397	referencia	3070970 37N1420
descripción	vidrio L 29mm An 29mm espesor 3.5mm cuadrado		
Para modelos:	06WCP1GM, 08WCP1GM, 08WFT1GV, 08WFT2GV, 08WFT3GV, 08WFT4GV, 08WFT6GV, 08WFT7GV, 090FT1G, 090FT2G, 090FT4G, 090FT5G, 090FT7G, 091CP1G, 091FR7G, 091FR7GS, 091FR7G-VERS.052012, 091FR7GX, 0A0FT1G, 0A0FT2G, 0A0FT4G, 0A0FT5G, 0A1CP1G, 0B0FT1G, 0B0FT2G, 0B0FT4G, 0B0FT5G, 0B1CP1G, 0D0FT1G, 0D0FT2G, 0D0FT4G, 0D0FT5G, 0D1CP1G, 0G0FT1G, 0G0FT1G-VERS.032008, 0G0FT2G, 0G0FT2G-VERS.032008, 0G0FT4G, 0G0FT4G-VERS.032008, 0G0FT5G, 0G0FT5G-VERS.032008, 0G0FT7G, 0G1CP1G, 0G1CP1G-VERS.2004, 0G1FR7G, 10CP1GA, 10CP1IA, 10WTPGE, 10WTPGV, 12CP1GA...(Otros modelos se puede ver en la tienda web)		

			
1			
código	691146	referencia	3000770
descripción	vidrio L 515mm An 505mm espesor 6mm rectangular		
Para modelos:	FM611E1, FM611E2, FM611E3, FM611G1, FM611G2, FM611G3		

			
1			
código	691147	referencia	3000760
descripción	vidrio L 720mm An 515mm espesor 6mm rectangular		
Para modelos:	FM1011E1, FM1011E2, FM1011E3, FM1011G1, FM1011G2, FM1011G3		

sistema de limpieza

boquillas



código	510626	referencia	33T1120 33T1121
descripción	boquilla de aclarado ø 0,7/1,5mm rosca 1/8" M		
Para modelos:	L100, L40, L40S, L60, L80		

uniones roscadas



código	362028	referencia	3041000
descripción	distribuidor 4+2 L 116mm plástico rosca M10 F		
Para modelos:	FM1011E3-VERS.2006, FM1011G3-VERS.2006, FM1221E3-VERS.2006, FM1221G3-VERS.2006, FM2011E3-VERS.2006, FM2011G3-VERS.2006, FM2021E3-VERS.2006, FM2021G3-VERS.2006, FM611E3-VERS.2006, FM611G3-VERS.2006, FM721E3-VERS.2006, FM721G3-VERS.2006		

tubos



código	521198	referencia	30Z2050
descripción	tubo de agua L 180mm An 120mm ø 11/12mm rosca M16x1,5		
Para modelos:	FC101, FC1011E, FC1011G, FC101E, FC1221E, FC1221G, FC241E, FC241G, FC61, FC611E, FC611G, FC61E, FCV101, FCV101-CSA, FCV101DM, FCV101DM-CSA, FCV101DS, FCV101DS-CSA, FCV101E, FCV101EDM, FCV101EDM-UL, FCV101EDS, FCV101E-UL, FCV141, FCV141-CSA, FCV141DM, FCV141DM-CSA, FCV141DS, FCV141DS-CSA, FCV141E, FCV141EDM, FCV141EDS, FCV241E, FCV241EDM, FCV241EDM-UL, FCV241EDS, FCV241EDS-UL, FCV241E-UL, FCV241G, FCV241G-CSA, FCV241GDM, FCV241GDM-CSA, FCV241GDS, FCV241GDS-CSA, FCV401DM, FCV401DM-CSA, FCV401EDM, FCV401EDM-UL, FCV61, FCV61-CSA...(Otros modelos se puede ver en la tienda web)		



código	521196	referencia	3120710
descripción	tubo de desagüe L 568mm An 182mm ø 30mm para horno a vapor combinado int.ø 21mm EPDM		
Para modelos:	BX101E, BX101E-VERS.122013, BX122E, BX122E-VERS.122013, BX122G, BX122G-VERS.122013, BX61E, BX61E-VERS.122013, BX82E, BX82E-VERS.122013, BX82G, BX82G-VERS.122013, FM423E1, FM423E2, FX101E1, FX101E1R, FX101E2, FX101E2C, FX101E2C-VERS.032014, FX101E2R, FX101E2R-VERS.032014, FX101E2-VERS.032014, FX101E3, FX101E3C, FX101E3C-VERS.022014, FX101E3R, FX101E3R-VERS.022014, FX101E3-VERS.022014, FX101G1, FX101G1R, FX101G2, FX101G2C, FX101G2R, FX101G3, FX101G3C, FX101G3R, FX10E2CR, FX10E2CR-VERS.032014, FX10E3CR, FX10E3CR-VERS.022014, FX10G2CR, FX10G3CR, FX122E1, FX122E2, FX122E2C, FX122E2T, FX122E2T-VERS.032014, FX122E3, FX122E3C, FX122E3T...(Otros modelos se puede ver en la tienda web)		

tubos flexibles



código	696792	referencia	3067460
descripción	tubo flexible int.ø 32mm ø ext. 40mm L 1000mm horno a vapor combinado		
Para modelos:	08WGREV, 091CP1E, 091CP1G, 10CP1EA, 10CP1GA, 10CP1IA, 12CP1EA, 12CP1GA, 12CP1IA, 18CP2EA, 18CP2GA, 18CP2IA, 191CP1G, 191CP2G, 6040090, 6040310, 6043850, 6043980, FMS, FMSX, PIER-06HD, PIER15HD		

kits de servicio



código	696773	referencia	6300833
descripción	pileta de desagüe juego para horno a vapor combinado tubo ø 8mm		
Para modelos:	FX101E3, FX101E3C, FX101E3C-VERS.022014, FX101E3R, FX101E3R-VERS.022014, FX101E3-VERS.022014, FX101G3, FX101G3C, FX101G3C-VERS.022014, FX101G3R, FX101G3R-VERS.022014, FX101G3-VERS.022014, FX10E3CR, FX10E3CR-VERS.022014, FX10G3CR, FX10G3CR-VERS.022014, FX122E3, FX122E3C, FX122E3T, FX122E3T-VERS.022014, FX122G3, FX122G3C, FX122G3T, FX122G3T-VERS.022014, FX12E3CT, FX12E3CT-VERS.022014, FX12G3CT, FX12G3CT-VERS.022014, FX201E3, FX201E3P, FX201E3P-VERS.022014, FX201E3-VERS.022014, FX201G3P, FX201G3-VERS.022014, FX202E3, FX202E3-230V-3-50Hz-60Hz, FX202E3-230V-3-50Hz-60Hz-VERS.022014, FX202E3-VERS.022014, FX202G3, FX202G3-VERS.022014, FX61E3, FX61E3C, FX61E3CR, FX61E3CR-VERS.022014, FX61E3C-VERS.022014, FX61E3R, FX61E3R-VERS.022014, FX61E3-VERS.022014, FX61G3, FX61G3C...(Otros modelos se puede ver en la tienda web)		

macánica de puertas

soportes



1

código	692858	referencia	6300798
descripción	soporte para puerta de vidrio horno a vapor combinado		
Para modelos:	FX101E1, FX101E2, FX101E2C, FX101E2C-VERS.032014, FX101E2-VERS.032014, FX101E3, FX101E3C, FX101E3C-VERS.022014, FX101E3R, FX101E3-VERS.022014, FX101G1, FX101G2, FX101G2C, FX101G2C-VERS.032014, FX101G2-VERS.032014, FX101G3, FX101G3C, FX101G3C-VERS.022014, FX101G3-VERS.022014, FX10E2CR-VERS.032014, FX122E1, FX122E2, FX122E2C, FX122E2T, FX122E2T-VERS.032014, FX122E3, FX122E3C, FX122E3T, FX122E3T-VERS.022014, FX122G1, FX122G3, FX122G3C, FX122G3T, FX122G3T-VERS.022014, FX12E3CT, FX12E3CT-VERS.022014, FX12G3CT, FX12G3CT-VERS.022014, FX61E1, FX61E2, FX61E2C, FX61E2C-VERS.032014, FX61E2-VERS.032014, FX61E3, FX61E3C, FX61E3C-VERS.022014, FX61E3-VERS.022014, FX61G1, FX61G2, FX61G2C... (Otros modelos se puede ver en la tienda web)		

mecánica de cierre



1

código	698503	referencia	6300965
descripción	cierre de pestillo espagnolette completo		
Para modelos:	FX201E2, FX201E2P, FX201E2P-VERS.032014, FX201E2-VERS.032014, FX201E3, FX201E3P, FX201E3P-VERS.022014, FX201E3-VERS.022014, FX201G2, FX201G2P, FX201G2P-VERS.032014, FX201G2-VERS.032014, FX201G3P, FX201G3-VERS.022014, FX202E2, FX202E2-VERS.032014, FX202E3, FX202E3-230V-3-50Hz-60Hz, FX202E3-230V-3-50Hz-60Hz-VERS.022014, FX202E3-VERS.022014, FX202G2, FX202G2-VERS.032014, FX202G3, FX202G3-VERS.022014		
accesorios para	698503		
	código	referencia	código
	690041	3088460	
	pestillo L 148mm distancia de sujeción 32mm		
	694409	—	
	kit de montaje para cierre de pestillo espagnolette 694382		
	700604	—	
	mecanismo de cierre apertura a derechas soporte de eje ø 8x8mm L 170mm An 40mm H 40mm		

accesorios



1

código	696774	referencia	3171920
descripción	casquillo para tirador de puerta ø 43mm agujero ø 20mm plástico		
Para modelos:	FX101E1, FX101E2, FX101E2C, FX101E2C-VERS.032014, FX101E2-VERS.032014, FX101E3, FX101E3C, FX101E3C-VERS.022014, FX101E3R, FX101E3-VERS.022014, FX101G1, FX101G2, FX101G2C, FX101G2C-VERS.032014, FX101G2-VERS.032014, FX101G3, FX101G3C, FX101G3C-VERS.022014, FX101G3-VERS.022014, FX10E2CR-VERS.032014, FX122E1, FX122E2, FX122E2C, FX122E2T, FX122E2T-VERS.032014, FX122E3, FX122E3C, FX122E3T, FX122E3T-VERS.022014, FX122G1, FX122G3, FX122G3C, FX122G3T, FX122G3T-VERS.022014, FX12E3CT, FX12E3CT-VERS.022014, FX12G3CT, FX12G3CT-VERS.022014, FX61E1, FX61E2, FX61E2C, FX61E2C-VERS.032014, FX61E2-VERS.032014, FX61E3, FX61E3C, FX61E3C-VERS.022014, FX61E3-VERS.022014, FX61G1, FX61G2, FX61G2C... (Otros modelos se puede ver en la tienda web)		

COMPONENTES ESPECÍFICOS ANGELO-PO



1

código	692859	referencia	3019510
descripción	placa de sujeción para cierre An 42mm chapa de acero tincado L 93.5mm		
Para modelos:	FC1011E, FC1011G, FC1221E, FC1221G, FC611E, FC611G, FM1011E1, FM1011E1-VERS.2006, FM1011E2, FM1011E2-VERS.2006, FM1011E3, FM1011E3-VERS.2006, FM1011G1, FM1011G1-VERS.2006, FM1011G2, FM1011G2-VERS.2006, FM1011G3, FM1011G3-VERS.2006, FM1221E1, FM1221E1-VERS.2006, FM1221E2, FM1221E2-VERS.2006, FM1221E3, FM1221E3-VERS.2006, FM1221G1, FM1221G1-VERS.2006, FM1221G2, FM1221G2-VERS.2006, FM1221G3, FM1221G3-VERS.2006, FM2011E2-VERS.2006, FM2011E3-VERS.2006, FM2011G2-VERS.2006, FM2011G3-VERS.2006, FM2021E1, FM2021E2, FM2021E2-VERS.2006, FM2021E3, FM2021E3-VERS.2006, FM2021G1, FM2021G2, FM2021G2-VERS.2006, FM2021G3, FM2021G3-VERS.2006, FM611E1, FM611E1-VERS.2006, FM611E2, FM611E2-VERS.2006, FM611E3, FM611E3-VERS.2006... (Otros modelos se puede ver en la tienda web)		



1

código	696775	referencia	36E2781
descripción	tope para puerta ø 15mm silicona L 20mm		
Para modelos:	BX101E, BX101E-VERS.122013, BX101G, BX101G-VERS.122013, BX122E, BX122E-VERS.122013, BX122G, BX122G-VERS.122013, BX82E, BX82E-VERS.122013, BX82G, BX82G-VERS.122013, FC1011E, FC1011G, FC1221E, FC1221G, FC611E, FC611G, FM1011E1, FM1011E1-VERS.2006, FM1011E2, FM1011E2-VERS.2006, FM1011E3, FM1011E3-VERS.2006, FM1011G1, FM1011G1-VERS.2006, FM1011G2, FM1011G2-VERS.2006, FM1011G3, FM1011G3-VERS.2006, FM1221E1, FM1221E1-VERS.2006, FM1221E2, FM1221E2-VERS.2006, FM1221E3, FM1221E3-VERS.2006, FM1221G1, FM1221G1-VERS.2006, FM1221G2, FM1221G2-VERS.2006, FM1221G3, FM1221G3-VERS.2006, FM2011E2-VERS.2006, FM2011E3-VERS.2006, FM2011G2-VERS.2006, FM2011G3-VERS.2006...(Otros modelos se puede ver en la tienda web)		

bombas de vibración



1

código	500972	referencia	32M7000 32M7001
descripción	bomba magnética 230V 47W 50Hz entrada ø 7 salida ø 1/8" F CEME tipo E507		
Para modelos:	FM1011E3, FM1011E3-VERS.2006, FM1011G3, FM1011G3-VERS.2006, FM1221E3, FM1221E3-VERS.2006, FM1221G3-VERS.2006, FM2011E3-VERS.2006, FM2011G3-VERS.2006, FM2021E3, FM2021E3-VERS.2006, FM2021G3, FM2021G3-VERS.2006, FM611E3, FM611E3-VERS.2006, FM611G3, FM611G3-VERS.2006, FM721E3, FM721E3-VERS.2006, FM721G3, FM721G3-VERS.2006		



intercambiadores de calor



código	521194	referencia	36E2350
descripción	junta para intercambiador térmico horno a vapor combinado int.ø 40mm dist. del agujero 52mm espesor 4mm		
Para modelos:	BX101G, BX101G-VERS.122013, BX61G, BX61G-VERS.122013, FC1011G, FM1011G1, FM1011G1-VERS.2006, FM1011G2, FM1011G2-VERS.2006, FM1011G3, FM1011G3-VERS.2006, FX101G1, FX101G1R, FX101G2, FX101G2C, FX101G2C-VERS.032014, FX101G2R, FX101G2R-VERS.032014, FX101G2-VERS.032014, FX101G3, FX101G3C, FX101G3C-VERS.022014, FX101G3R, FX101G3R-VERS.022014, FX101G3-VERS.022014, FX10G2CR, FX10G2CR-VERS.032014, FX10G3CR, FX10G3CR-VERS.022014, FX201G2, FX201G2P, FX201G2P-VERS.032014, FX201G2-VERS.032014, FX201G3P, FX201G3-VERS.022014, FX61G1, FX61G1R, FX61G2, FX61G2C, FX61G2CR, FX61G2CR-VERS.032014, FX61G2C-VERS.032014, FX61G2R, FX61G2R-VERS.032014, FX61G2-VERS.032014, FX61G3, FX61G3C, FX61G3CR, FX61G3CR-VERS.022014, FX61G3C-VERS.022014...(Otros modelos se puede ver en la tienda web)		



código	521195	referencia	36E3570
descripción	junta para intercambiador térmico horno a vapor combinado int.ø 52mm dist. del agujero 63mm espesor 3mm		
Para modelos:	BX122G, BX122G-VERS.122013, BX82G, BX82G-VERS.122013, FC1221G, FM1221G1, FM1221G1-VERS.2006, FM1221G2, FM1221G2-VERS.2006, FM1221G3, FM1221G3-VERS.2006, FM2021G1, FM2021G2, FM2021G2-VERS.2006, FM2021G3, FM2021G3-VERS.2006, FM721G1, FM721G1-VERS.2006, FM721G2, FM721G2-VERS.2006, FM721G3, FM721G3-VERS.2006, FX122G1, FX122G2, FX122G2C, FX122G2T, FX122G2T-VERS.032014, FX122G3, FX122G3C, FX122G3T, FX122G3T-VERS.022014, FX12G3CT, FX12G3CT-VERS.022014, FX202G2, FX202G2-VERS.032014, FX202G3, FX202G3-VERS.022014, FX82G1, FX82G2, FX82G2C, FX82G2T, FX82G2T-VERS.032014, FX82G3, FX82G3C, FX82G3CT, FX82G3CT-VERS.022014, FX82G3T, FX82G3T-VERS.022014		

otros



código	691180	referencia	3120100
descripción	arandela		
Para modelos:	10CP1EA, 10CP1GA, 10CP1IA, 12CP1EA, 12CP1GA, 12CP1IA, 18CP2EA, 18CP2GA, 18CP2IA, C304AD, C304AS, C304AVD, C304AVS, CS370AD, CS370AS, CS370AVD, CS370AVS, CS466AD, CS466AS, CS466AVD, CS466AVS, FCV101DM, FCV101DM-CSA, FCV101DS, FCV101DS-CSA, FCV101EDM, FCV101EDM-UL, FCV101EDS, FCV101EDS-UL, FCV141DM, FCV141DM-CSA, FCV141DS, FCV141DS-CSA, FCV141EDM, FCV141EDS, FCV241DM, FCV241DS, FCV241EDM, FCV241EDM-UL, FCV241EDS, FCV241EDS-UL, FCV241GDM, FCV241GDM-CSA, FCV241GDS, FCV241GDS-CSA, FCV401DM, FCV401DM-CSA, FCV401EDM, FCV401EDM-UL, FCV4EDS...(Otros modelos se puede ver en la tienda web)		

código	691179	referencia	33Q0730
descripción	casquillo rosca M10x1 ø 5mm		
Para modelos:	FCV101DM, FCV101DM-CSA, FCV101DS, FCV101DS-CSA, FCV101EDM, FCV101EDM-UL, FCV101EDS, FCV101EDS-UL, FCV141DM, FCV141DM-CSA, FCV141DS, FCV141DS-CSA, FCV141EDM, FCV141EDS, FCV241DM, FCV241DS, FCV241EDM, FCV241EDM-UL, FCV241EDS, FCV241EDS-UL, FCV241GDM, FCV241GDM-CSA, FCV241GDS, FCV241GDS-CSA, FCV401DM, FCV401DM-CSA, FCV401EDM, FCV401EDM-UL, FCV4EDS, FCV61DM, FCV61DM-CSA, FCV61DS, FCV61DS-CSA, FCV61EDM, FCV61EDM-UL, FCV61EDS, FCV61EDS-UL, FCV72EDM-UL, FCV72EDS-UL, FM1011E2, FM1011E3, FM1011G2, FM1011G3, FM1221E2, FM1221E3, FM1221G2, FM1221G3, FM2021E2, FM2021E3, FM2021G2...(Otros modelos se puede ver en la tienda web)		
accesorios para	691179		
descripción	junta para sensor de temperatura al corazón ø ext. 8mm int.ø 4mm espesor 5mm		
código	519385	referencia	3150220
descripción	junta para sensor de temperatura al corazón ø ext. 8mm int.ø 4mm espesor 5mm		
código	691180	referencia	3120100
descripción	arandela		

código	542121	referencia	3032890
descripción	empalme de tubo para manómetro L 60mm EC 17 latón rosca 1/8" ø 12mm G2: M8		
Para modelos:	BX101E, BX101E-VERS.122013, BX101G, BX101G-VERS.122013, FC1011E, FC1011G, FC1221E, FC1221G, FC611E, FC611G, FM1011E1, FM1011E1-VERS.2006, FM1011E2, FM1011E2-VERS.2006, FM1011E3, FM1011E3-VERS.2006, FM1011G1, FM1011G1-VERS.2006, FM1011G2, FM1011G2-VERS.2006, FM1011G3, FM1011G3-VERS.2006, FM1221E1-VERS.2006, FM1221E2-VERS.2006, FM1221E3, FM1221E3-VERS.2006, FM1221G1-VERS.2006, FM1221G2-VERS.2006, FM1221G3, FM1221G3-VERS.2006, FM2011E2-VERS.2006, FM2011E3-VERS.2006, FM2011G2-VERS.2006, FM2011G3-VERS.2006, FM2021E1, FM2021E2, FM2021E2-VERS.2006, FM2021E3, FM2021E3-VERS.2006, FM2021G1, FM2021G2, FM2021G2-VERS.2006, FM2021G3, FM2021G3-VERS.2006, FM611E1, FM611E1-VERS.2006, FM611E2, FM611E2-VERS.2006, FM611E3, FM611E3-VERS.2006...(Otros modelos se puede ver en la tienda web)		

código	541486	referencia	33Q5901
descripción	empalme de tubo para manómetro taladro ø 0.4mm rosca 1/8"		
Para modelos:	FM423E1, FM423E2		
accesorios para	541486		
descripción	manómetro ø 40mm margen de presión 0-4bar empalme rosca 1/8"		
código	541508	referencia	33D1680



1

código	691123	referencia	36E2060
descripción	orificio de paso para abrepuertas		
Para modelos:	FCV3EM, FCV4E, FCV4EDS, FCV4EM, FM423E1, FM423E2		



1

código	697869	referencia	3010750
descripción	pletina sujeción para ventilador acero		
Para modelos:	FM1011G1, FM1011G2, FM1011G3, FM611G1, FM611G2, FM611G3, FM721G1, FM721G2, FM721G3		



1

código	697870	referencia	3010670
descripción	protección para aspiración		
Para modelos:	FM1011G1, FM1011G2, FM1011G3, FM1221G1, FM1221G2, FM1221G3, FM2021G1, FM2021G2, FM2021G3, FM611G1, FM611G2, FM611G3		

para sartén basculante

árboles de accionamiento



1

código	514043	referencia	36G1290
descripción	árbol para sartén basculante soporte \varnothing 16mm		
Para modelos:	1G1BR1E, 1G1BR1G, 31R, 31RE		

recambios y accesorios



1

código	693824	referencia	36G6431
descripción	extensión L 255mm rosca M14x1,5 \varnothing 25mm		



1

código	700734	referencia	36E0440
descripción	perno roscado rosca M5 D1 \varnothing 18mm D2 \varnothing 12mm		
Para modelos:	191BR1E, 191BR1G, 191BR1GA, 191BR2E, 191BR2EA, 191BR2G, 191BR2GA, 1A1BR1E, 1A1BR1G, 1A1BR1GA, 1A1BR2E, 1A1BR2EA, 1A1BR2G, 1A1BR2GA, 1D1BR1E, 1D1BR1G, 1D1BR1GA, 1D1BR2E, 1D1BR2EA, 1D1BR2G, 1D1BR2GA, 291BR1E, 291BR1G, 291BR1GA, 291BR2E, 291BR2EA, 291BR2G, 291BR2GA, 2A1BR1E, 2A1BR1G, 2A1BR1GA, 2A1BR2E, 2A1BR2EA, 2A1BR2G, 2A1BR2GA, 2D1BR1E, 2D1BR1G, 2D1BR1GA, 2D1BR2E, 2D1BR2EA, 2D1BR2G, 2D1BR2GA		



1

código	700735	referencia	36E0870
descripción	pieza distanciadora		
Para modelos:	191BR1E, 191BR1G, 191BR1GA, 191BR2E, 191BR2EA, 191BR2G, 191BR2GA, 1A1BR1E, 1A1BR1G, 1A1BR1GA, 1A1BR2E, 1A1BR2EA, 1A1BR2G, 1A1BR2GA, 1D1BR1E, 1D1BR1G, 1D1BR1GA, 1D1BR2E, 1D1BR2EA, 1D1BR2G, 1D1BR2GA, 291BR1E, 291BR1G, 291BR1GA, 291BR2E, 291BR2EA, 291BR2G, 291BR2GA, 2A1BR1E, 2A1BR1G, 2A1BR1GA, 2A1BR2E, 2A1BR2EA, 2A1BR2G, 2A1BR2GA, 2D1BR1E, 2D1BR1G, 2D1BR1GA, 2D1BR2E, 2D1BR2EA, 2D1BR2G, 2D1BR2GA		

cajas y paneles frontales



código	691184	referencia	36D3420
descripción	tapa terminal para panel de manejo pos. de montaje derecho		
Para modelos:	030, 030BME, 030E, 030EBM, 030FE, 030FE1, 030FE1B, 030FT, 030FTE, 030FTER, 030FTR, 031, 031BME, 031E, 031EBM, 031FT, 031FT04, 031FT06, 031FTE, 031FTE04, 031FTE06, 031FTER, 031FTERL, 031FTR, 031FTRL, 031TP, 032, 070BM, 070BME, 070D, 070DGG, 070E, 070FT, 070FT04, 070FT05, 070FTE, 070FTE04, 070FTE05, 070FTER, 070FTR, 0712D, 0712VA, 071BM, 071BME, 071D, 071DGG, 071E, 071FT, 071FT04, 071FT06...(Otros modelos se puede ver en la tienda web)		

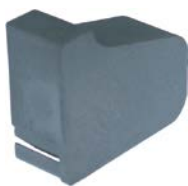

código	691183	referencia	36D3430
descripción	tapa terminal para panel de manejo pos. de montaje izquierdo		
Para modelos:	030, 030BME, 030E, 030EBM, 030FE, 030FE1, 030FE1B, 030FT, 030FTE, 030FTER, 030FTR, 031, 031BME, 031E, 031EBM, 031FT, 031FT04, 031FT06, 031FTE, 031FTE04, 031FTE06, 031FTER, 031FTERL, 031FTR, 031FTRL, 031TP, 032, 070BM, 070BME, 070D, 070DGG, 070E, 070FT, 070FT04, 070FT05, 070FTE, 070FTE04, 070FTE05, 070FTER, 070FTR, 0712D, 0712VA, 071BM, 071BME, 071D, 071DGG, 071E, 071FT, 071FT04, 071FT06...(Otros modelos se puede ver en la tienda web)		

vidrios



código	693397	referencia	3070970 37N1420
descripción	vidrio L 29mm An 29mm espesor 3.5mm cuadrado		
Para modelos:	06WCP1GM, 08WCP1GM, 08WFT1GV, 08WFT2GV, 08WFT3GV, 08WFT4GV, 08WFT6GV, 08WFT7GV, 090FT1G, 090FT2G, 090FT4G, 090FT5G, 090FT7G, 091CP1G, 091FR7G, 091FR7GS, 091FR7G-VERS.052012, 091FR7GX, 0A0FT1G, 0A0FT2G, 0A0FT4G, 0A0FT5G, 0A1CP1G, 0B0FT1G, 0B0FT2G, 0B0FT4G, 0B0FT5G, 0B1CP1G, 0D0FT1G, 0D0FT2G, 0D0FT4G, 0D0FT5G, 0D1CP1G, 0G0FT1G, 0G0FT1G-VERS.032008, 0G0FT2G, 0G0FT2G-VERS.032008, 0G0FT4G, 0G0FT4G-VERS.032008, 0G0FT5G, 0G0FT5G-VERS.032008, 0G0FT7G, 0G1CP1G, 0G1CP1G-VERS.2004, 0G1FR7G, 10CP1GA, 10CP1IA, 10WTPGE, 10WTPGV, 12CP1GA...(Otros modelos se puede ver en la tienda web)		

tornillos sin fin



código	514044	referencia	36G8110
descripción	barra roscada rosca M10x1,5 L 640mm ø 20mm		
Para modelos:	191BR1E, 191BR1G, 191BR2E, 191BR2G, 1A1BR1E, 1A1BR1G, 1A1BR2E, 1A1BR2G, 1D1BR1E, 1D1BR1G, 1D1BR2E, 1D1BR2G, 291BR1E, 291BR1G, 291BR2E, 291BR2G, 2A1BR1E, 2A1BR2E, 2D1BR1E, 2D1BR2E		

código	693099	referencia	36G6440
descripción	barra roscada rosca M14x1 L 300mm ø 24mm		
accesorios para	693099		
código	693645	referencia	36G6450
descripción	casquillo roscado		
código	693824	referencia	36G6431
descripción	extensión L 255mm rosca M14x1,5 ø 25mm		

código	514041	referencia	36G1170
descripción	barra roscada rosca M14x1,5 L 615mm ø 25mm		
Para modelos:	31R, 31RE		

código	514064	referencia	36C0940
descripción	soporte de rodamiento para sartén basculante int.ø 19/35mm ø ext. 14mm		
Para modelos:	1G1BR1E, 1G1BR1G, 31R, 31RE		

otros

código	693645	referencia	36G6450
descripción	casquillo roscado		
accesorios para	693645		
código	693099	referencia	36G6440
descripción	barra roscada rosca M14x1 L 300mm ø 24mm		

código	514249	referencia	36G1250
descripción	casquillo roscado para sartén basculante		
Para modelos:	1G1BR1E, 1G1BR1G, 31R, 31RE		



1

código	691187	referencia	36D9390
descripción	cojinete ø 15/20mm para sartén basculante		
Para modelos:	1G1BR1E, 1G1BR1G, 31R, 31RE		



1

código	105375	referencia	30Z2130
descripción	distribuidor de gas		
Para modelos:	1A1BR1G, 1A1BR1GA, 1A1BR2G, 1A1BR2GA, 1D1BR1G, 1D1BR1GA, 1D1BR2G, 1D1BR2GA, 2A1BR1G, 2A1BR1GA, 2A1BR2G, 2A1BR2GA, 2D1BR1G, 2D1BR1GA, 2D1BR2G, 2D1BR2GA		



1

código	500915	referencia	36G2082
descripción	pistón L 270mm ø 40mm para sartén basculante		
Para modelos:	71ARE, 71RA, 91ARE, 91RA		



1

código	514046	referencia	36C2830
descripción	soporte para cojinete		
Para modelos:	191BR1E, 191BR1G, 191BR2E, 191BR2G, 1A1BR1E, 1A1BR1G, 1A1BR2E, 1A1BR2G, 1D1BR1E, 1D1BR1G, 1D1BR2E, 1D1BR2G, 291BR1E, 291BR1G, 291BR2E, 291BR2G, 2A1BR1E, 2A1BR1G, 2A1BR2E, 2A1BR2G, 2D1BR1E, 2D1BR1G, 2D1BR2E, 2D1BR2G		



1

código	698477	referencia	33Q3780
descripción	tubo de agua para sartén basculante para ANGELO PO		
Para modelos:	191BR1E, 191BR1G, 191BR1GA, 191BR2E, 191BR2EA, 191BR2G, 191BR2GA, 1A1BR1E, 1A1BR1G, 1A1BR1GA, 1A1BR2E, 1A1BR2EA, 1A1BR2G, 1A1BR2GA, 1D1BR1E, 1D1BR1G, 1D1BR1GA, 1D1BR2E, 1D1BR2EA, 1D1BR2G, 1D1BR2GA, 1G1BR1E, 1G1BR1G, 291BR1E, 291BR1G, 291BR1GA, 291BR2E, 291BR2EA, 291BR2G, 291BR2GA, 2A1BR1E, 2A1BR1G, 2A1BR1GA, 2A1BR2E, 2A1BR2EA, 2A1BR2G, 2A1BR2GA, 2D1BR1E, 2D1BR1G, 2D1BR1GA, 2D1BR2E, 2D1BR2EA, 2D1BR2G, 2D1BR2GA		

para marmitas

filtros



1

código	514388	referencia	30Q0450
descripción	filtro de desagüe marmita		
Para modelos:	191PD1G, 191PD2G, 191PI1G, 191PI1GA, 191PI2E, 191PI2EA, 191PI2G, 191PI2GA, 191PI2V, 191PI2VA, 1A1PD1G, 1A1PD2G, 1A1PI1G, 1A1PI1GA, 1A1PI2E, 1A1PI2EA, 1A1PI2V, 1A1PI2VA, 1D1PD1G, 1D1PD2G, 1D1PI1G, 1D1PI1GA, 1D1PI2E, 1D1PI2EA, 1D1PI2V, 1D1PI2VA, 1G1PD1G, 1G1PI1E, 1G1PI1G, 31PD6, 31PI6, 31PIE6, 71PD10, 71PD15, 71PI10, 71PI10A, 71PIE15, 71PIE15A, 71PV15, 71PV15A, 91PI10, 91PI10A, 91PIE15, 91PIE15A		

cajas y paneles frontales



1

código	691184	referencia	36D3420
descripción	tapa terminal para panel de manejo pos. de montaje derecho		
Para modelos:	030, 030BME, 030E, 030EBM, 030FE, 030FE1, 030FE1B, 030FT, 030FTE, 030FTER, 030FTR, 031, 031BME, 031E, 031EBM, 031FT, 031FT04, 031FT06, 031FTE, 031FTE04, 031FTE06, 031FTER, 031FTERL, 031FTR, 031FTRL, 031TP, 032, 070BM, 070BME, 070D, 070DGG, 070E, 070FT, 070FT04, 070FT05, 070FTE, 070FTE04, 070FTE05, 070FTER, 070FTR, 0712D, 0712VA, 071BM, 071BME, 071D, 071DGG, 071E, 071FT, 071FT04, 071FT06...(Otros modelos se puede ver en la tienda web)		



1

código	691183	referencia	36D3430
descripción	tapa terminal para panel de manejo pos. de montaje izquierdo		
Para modelos:	030, 030BME, 030E, 030EBM, 030FE, 030FE1, 030FE1B, 030FT, 030FTE, 030FTER, 030FTR, 031, 031BME, 031E, 031EBM, 031FT, 031FT04, 031FT06, 031FTE, 031FTE04, 031FTE06, 031FTER, 031FTERL, 031FTR, 031FTRL, 031TP, 032, 070BM, 070BME, 070D, 070DGG, 070E, 070FT, 070FT04, 070FT05, 070FTE, 070FTE04, 070FTE05, 070FTER, 070FTR, 0712D, 0712VA, 071BM, 071BME, 071D, 071DGG, 071E, 071FT, 071FT04, 071FT06...(Otros modelos se puede ver en la tienda web)		

vidrios



1

código	693397	referencia	3070970 37N1420
descripción	vidrio L 29mm An 29mm espesor 3.5mm cuadrado		
Para modelos:	06WCP1GM, 08WCP1GM, 08WFT1GV, 08WFT2GV, 08WFT3GV, 08WFT4GV, 08WFT6GV, 08WFT7GV, 090FT1G, 090FT2G, 090FT4G, 090FT5G, 090FT7G, 091CP1G, 091FR7G, 091FR7GS, 091FR7G-VERS.052012, 091FR7GX, 0A0FT1G, 0A0FT2G, 0A0FT4G, 0A0FT5G, 0A1CP1G, 0B0FT1G, 0B0FT2G, 0B0FT4G, 0B0FT5G, 0B1CP1G, 0D0FT1G, 0D0FT2G, 0D0FT4G, 0D0FT5G, 0D1CP1G, 0G0FT1G, 0G0FT1G-VERS.032008, 0G0FT2G, 0G0FT2G-VERS.032008, 0G0FT4G, 0G0FT4G-VERS.032008, 0G0FT5G, 0G0FT5G-VERS.032008, 0G0FT7G, 0G1CP1G, 0G1CP1G-VERS.2004, 0G1FR7G, 10CP1GA, 10CP1IA, 10WTPGE, 10WTPGV, 12CP1GA...(Otros modelos se puede ver en la tienda web)		

otros



1

código	514386	referencia	36M0830
descripción	estribo de cierre para marmita		
Para modelos:	71PI10A, 71PIE15A, 71PV15A, 91PI10, 91PI10A, 91PIE15A		
accesorios para	514386		
	código	514387	referencia 36M0840
	tornillo de cierre		

para hornos

recambios y accesorios



1

código	691172	referencia	35S5970
descripción	guía para guía contrapeso		
Para modelos:	FC101, FC101E, FC241, FC241E, FC241G, FC61, FC61E, FCV101, FCV101-CSA, FCV101DM, FCV101DM-CSA, FCV101DS, FCV101DS-CSA, FCV101E, FCV101EDM, FCV101EDM-UL, FCV101EDS, FCV101EDS-UL, FCV101E-UL, FCV141, FCV141-CSA, FCV141DM, FCV141DM-CSA, FCV141DS, FCV141DS-CSA, FCV141E, FCV141EDM, FCV141EDS, FCV241, FCV241DM, FCV241DS, FCV241E, FCV241EDM, FCV241EDM-UL, FCV241EDS, FCV241EDS-UL, FCV241E-UL, FCV241G, FCV241G-CSA, FCV241GDM, FCV241GDM-CSA, FCV241GDS, FCV241GDS-CSA, FCV61, FCV61-CSA, FCV61DM, FCV61DM-CSA, FCV61DS, FCV61DS-CSA, FCV61E...(Otros modelos se puede ver en la tienda web)		

cajas y paneles frontales



1

código	691184	referencia	36D3420
descripción	tapa terminal para panel de manejo pos. de montaje derecho		
Para modelos:	030, 030BME, 030E, 030EBM, 030FE, 030FE1, 030FE1B, 030FT, 030FTE, 030FTER, 030FTR, 031, 031BME, 031E, 031EBM, 031FT, 031FT04, 031FT06, 031FTE, 031FTE04, 031FTE06, 031FTER, 031FTERL, 031FTR, 031FTRL, 031TP, 032, 070BM, 070BME, 070D, 070DGG, 070E, 070FT, 070FT04, 070FT05, 070FTE, 070FTE04, 070FTE05, 070FTER, 070FTR, 0712D, 0712VA, 071BM, 071BME, 071D, 071DGG, 071E, 071FT, 071FT04, 071FT06...(Otros modelos se puede ver en la tienda web)		



1

código	691183	referencia	36D3430
descripción	tapa terminal para panel de manejo pos. de montaje izquierdo		
Para modelos:	030, 030BME, 030E, 030EBM, 030FE, 030FE1, 030FE1B, 030FT, 030FTE, 030FTER, 030FTR, 031, 031BME, 031E, 031EBM, 031FT, 031FT04, 031FT06, 031FTE, 031FTE04, 031FTE06, 031FTER, 031FTERL, 031FTR, 031FTRL, 031TP, 032, 070BM, 070BME, 070D, 070DGG, 070E, 070FT, 070FT04, 070FT05, 070FTE, 070FTE04, 070FTE05, 070FTER, 070FTR, 0712D, 0712VA, 071BM, 071BME, 071D, 071DGG, 071E, 071FT, 071FT04, 071FT06...(Otros modelos se puede ver en la tienda web)		

placas de fundición



código	109719	referencia	35D4340
descripción	placa de fundición L 530mm An 545mm		
Para modelos:	08WFA4E, 08WFA4G, 08WFAAE, 08WFAAG, 10WTPGE, 12WFA6E, 12WFA6G, 12WFAAE, 12WFAAG, 1B1FAS2G, 1B1FASG, 1G1FA0EV, 1G1FA0GV, 1G1PE1EV, 1G1PE2EV, 2G1FA0GV, 2G1PE1EV, 2G1PE2EV, 31, 31GE, 31TC, 31TCE, 31TP, 32, 32TC, 32TCE, 32TP, 32TPV, 32V, 6043590, 712D, 712VA		

otros



código	698478	referencia	3142670
descripción	acoplamiento para horno para puerta L 80mm An 26mm soporte 7,8 x 7,8		
Para modelos:	FX201E2, FX201E2P, FX201E2P-VERS.032014, FX201E2-VERS.032014, FX201E3, FX201E3P, FX201E3P-VERS.022014, FX201E3-VERS.022014, FX201G2, FX201G2P, FX201G2P-VERS.032014, FX201G2-VERS.032014, FX201G3P, FX201G3-VERS.022014, FX202E2, FX202E2-VERS.032014, FX202E3, FX202E3-230V-3-50Hz-60Hz, FX202E3-230V-3-50Hz-60Hz-VERS.022014, FX202E3-VERS.022014, FX202G2, FX202G2-VERS.032014, FX202G3, FX202G3-VERS.022014		

para lavavajillas

componentes de salida/aspiración

ANGELO PO

cuerpo de salida/aspiración



código	510681	referencia	36G9130
descripción	cuerpo tubo ø 32mm		
Para modelos:	LC100-VERS.2001, LC130, LC130-VERS.2001		



código	511440	referencia	33Q2110 6000340
descripción	empalme de desagüe completo		
Para modelos:	L40, L40S, L60		



código	517182	referencia	3030150
descripción	empalme de desagüe rosca 1" int.ø 27mm tubo ø 30mm		
Para modelos:	KD37, KD40, LP202, LP202HC, LP302, LP302HC, LP402, LP402HC, LP402V, LPG300		

accesorios para 517182

código	517180	referencia	3030170
descripción	tuerca rosca 1" H 5mm EC 36 inox UE 1 pzs		

código	517181	referencia	3030160
descripción	junta plana goma ø ext. 44mm int.ø 32mm espesor 3mm UE 1 pzs		



código	517181	referencia	3030160
descripción	junta plana goma ø ext. 44mm int.ø 32mm espesor 3mm UE 1 pzs		
Para modelos:	KD37, KD40, LP202, LP202HC, LP302, LP302HC, LP402, LP402HC, LP402V, N100D, N100S, N100VD, N100VS, N38D, N38S, N38VD, N38VS, N42D, N42S, N42VD, N42VS, N50D, N50S, N50VD, N50VS, N66D, N66S, N66VD, N66VS, N70D, N70S, N70VD, N70VS, N85D, N85S, N85VD, N85VS		



código	519179	referencia	3151930
descripción	junta tórica EPDM espesor 3.53mm int.ø 41.28mm UE 1 pzs		
Para modelos:	C165D, C165S, C165VD, C165VS, C207D, C207D-VERS.2006, C207S, C207S-VERS.2006, C207VD, C207VD-VERS.2006, C207VS, C207VS-VERS.2006, C304AD, C304AD-VERS.2006, C304AS, C304AS-VERS.2006, C304AVD, C304AVD-VERS.2006, C304AVS, C304AVS-VERS.2006, C304D, C304D-VERS.2006, C304S, C304S-VERS.2006, C304VD, C304VD-VERS.2006, C304VS, C304VS-VERS.2006, C92D-VERS.2006, C92S-VERS.2006, C92VD-VERS.2006, C92VS-VERS.2006, CS243D, CS243D-VERS.2006, CS243S, CS243S-VERS.2006, CS243VD, CS243VD-VERS.2006, CS243VS, CS243VS-VERS.2006, CS370AD, CS370AD-VERS.2006, CS370AS, CS370AS-VERS.2006, CS370AVD, CS370AVD-VERS.2006, CS370AVS, CS370AVS-VERS.2006, CS370D, CS370D-VERS.2006...(Otros modelos se puede ver en la tienda web)		







1

código	532114	referencia	3150240
descripción	junta tórica EPDM espesor 3.53mm int.ø 50.8mm UE 10 pzs		
Para modelos:	L100, L40, L40S, L60, L80		



1

código	511914	referencia	33M0170
descripción	pileta de desagüe ø ext. 110mm int.ø 80mm tubo ø 28/45mm		
Para modelos:	F60P, F60PR, F60T, F80P, F80PR, L45		
repuestos para	511914		
	código	referencia	33M0180
	brida para sujeción de filtro		
	código	referencia	3150290
	junta goma ø ext. 110mm int.ø 83mm espesor 3mm UE 1 pzs		
accesorios para	511914		
	código	referencia	3150290
	junta goma ø ext. 110mm int.ø 83mm espesor 3mm UE 1 pzs		





1

código	507574	referencia	33Q4740
descripción	pileta de desagüe rosca 1¼" ø ext. 54mm H 40mm int.ø 36/33mm		
Para modelos:	C165D, C165S, C165VD, C165VS, C207D, C207D-VERS.2006, C207S, C207S-VERS.2006, C207VD, C207VD-VERS.2006, C207VS, C207VS-VERS.2006, C304AD, C304AD-VERS.2006, C304AS, C304AS-VERS.2006, C304AVD, C304AVD-VERS.2006, C304AVS, C304AVS-VERS.2006, C304D, C304D-VERS.2006, C304S, C304S-VERS.2006, C304VD, C304VD-VERS.2006, C304VS, C304VS-VERS.2006, C92D-VERS.2006, C92S-VERS.2006, C92VD-VERS.2006, C92VS-VERS.2006, CS243D, CS243D-VERS.2006, CS243S, CS243S-VERS.2006, CS243VD, CS243VD-VERS.2006, CS243VS, CS243VS-VERS.2006, CS370AD, CS370AD-VERS.2006, CS370AS, CS370AS-VERS.2006, CS370AVD, CS370AVD-VERS.2006, CS370AVS, CS370AVS-VERS.2006, CS370D, CS370D-VERS.2006...(Otros modelos se puede ver en la tienda web)		



1

código	519232	referencia	33D3090 33Q2290
descripción	pileta de desagüe rosca 1¼" ø ext. 54mm int.ø 35mm		
Para modelos:	C165D, C165S, C165VD, C165VS, C207D, C207S, C207VD, C207VS, C304AD, C304AS, C304AVD, C304AVS, C304D, C304S, C304VD, C304VS, CS243D, CS243S, CS243VD, CS243VS, CS370AD, CS370AS, CS370AVD, CS370AVS, CS370D, CS370S, CS370VD, CS370VS, CS466AD, CS466AS, CS466AVD, CS466AVS, CS466D, CS466S, CS466VD, CS466VS, LC100-VERS.2001, LC130-VERS.2001, LF50E, LF50EM, LF50EMPS, LF50E-VERS.2007, LP124, LP124S-VERS.052006, LP124V, LP124-VERS.052006, LP124VS-VERS.052006, LP124V-VERS.052006, LP84, LP84S-VERS.052006...(Otros modelos se puede ver en la tienda web)		
accesorios para	519232		
	código	referencia	—
	tuerca rosca 1¼"		
	código	referencia	3151930
	junta tórica EPDM espesor 3.53mm int.ø 41.28mm UE 1 pzs		



1

código	503505	referencia	33Q3050
descripción	pileta de desagüe rosca 1½"		
Para modelos:	L100, L40, L40S, L60, L80		
accesorios para	503505		
	código	referencia	3150240
	junta tórica EPDM espesor 3.53mm int.ø 50.8mm UE 10 pzs		







1

código	517254	referencia	33D3340
descripción	pileta de desagüe rosca 2"/1¼" H 64mm int.ø 43mm		
Para modelos:	KD100, KD100A, KD100PSD, LP151		
accesorios para	517254		
	código	referencia	—
	junta plana goma ø ext. 75mm int.ø 58mm espesor 3mm UE 1 pzs		
	código	referencia	—
	tuerca rosca 2"		

			
1			
código	517180	referencia	3030170
descripción	tuerca rosca 1" H 5mm EC 36 inox UE 1 pzs		
Para modelos:	KD37, KD37PS, KD37-VERS.112009, KD40, LP202, LP202HC, LP302, LP302HC, LP402, LP402HC, LP402V, LPG300, N100D, N100S, N100VD, N100VS, N38D, N38S, N38VD, N38VS, N42D, N42S, N42VD, N42VS, N50D, N50S, N50VD, N50VS, N66D, N66S, N66VD, N66VS, N70D, N70S, N70VD, N70VS, N85D, N85S, N85VD, N85VS		

			
1			
código	505505	referencia	33Q2160
descripción	tuerca rosca 1¼" EC 55 plástico		
Para modelos:	C165D, C165S, C165VD, C165VS, C207D, C207D-VERS.2006, C207S, C207S-VERS.2006, C207VD, C207VD-VERS.2006, C207VS, C207VS-VERS.2006, C304AD, C304AD-VERS.2006, C304AS, C304AS-VERS.2006, C304AVD, C304AVD-VERS.2006, C304AVS, C304AVS-VERS.2006, C304D, C304D-VERS.2006, C304S, C304S-VERS.2006, C304VD, C304VD-VERS.2006, C304VS, C304VS-VERS.2006, C92D-VERS.2006, C92S-VERS.2006, C92VD-VERS.2006, C92VS-VERS.2006, CS243D, CS243D-VERS.2006, CS243S, CS243S-VERS.2006, CS243VD, CS243VD-VERS.2006, CS243VS, CS243VS-VERS.2006, CS370AD, CS370AD-VERS.2006, CS370AS, CS370AS-VERS.2006, CS370AVD, CS370AVD-VERS.2006, CS370AVS, CS370AVS-VERS.2006, CS370D, CS370D-VERS.2006...(Otros modelos se puede ver en la tienda web)		

			
1			
código	510356	referencia	33Q2320
descripción	tuerca rosca 1½"		
accesorios para	510356		
	código	510876	referencia
			—
	junta plana goma ø ext. 45mm int.ø 33mm espesor 3mm UE 1 pzs		
	código	511298	referencia
			—
	empalme de tubo tubo ø 35mm		

			
1			
código	511309	referencia	33Q0240
descripción	tuerca rosca 1½" ø 66mm H 9mm EC 51 latón UE 1 pzs		
Para modelos:	L100, L40, L40S, L60, L80		

filtros			
			
1			
código	511915	referencia	33M0180
descripción	brida para sujeción de filtro		
Para modelos:	F60P, F60PR, F60T, F80P, F80PR, L45		

			
1			
código	519063	referencia	30Q1330
descripción	filtro H 75mm L 160mm An 75mm		
Para modelos:	CS243D-VERS.2006, CS243S-VERS.2006, CS243VD-VERS.2006, CS243VS-VERS.2006, CS370AD-VERS.2006, CS370AS-VERS.2006, CS370AVD-VERS.2006, CS370AVS-VERS.2006, CS370D-VERS.2006, CS370S-VERS.2006, CS370VD-VERS.2006, CS370VS-VERS.2006, CS466AD-VERS.2006, CS466AS-VERS.2006, CS466AVD-VERS.2006, CS466AVS-VERS.2006, CS466D-VERS.2006, CS466S-VERS.2006, CS466VD-VERS.2006, CS466VS-VERS.2006, LF50, LF50E, LF50EM, LF50EMPS-VERS.122012, LF50EM-VERS.122012, LF50E-VERS.122012, LF50E-VERS.2007, LP70		

			
1			
código	519391	referencia	35Q1030
descripción	filtro aspiración ø 77mm H 100mm		

			
1			
código	504251	referencia	30Q0490
descripción	filtro de desagüe ø 105mm H 80mm agujero ø 40mm		
Para modelos:	F60P, F60T, F80P, L45		

			
1			
código	519064	referencia	30Q0300 30Q1510
descripción	filtro de desagüe ø 96mm H 81mm		
Para modelos:	F60P, F60PR, F80PR, L45		

			
1			
código	507381	referencia	30G0140
descripción	filtro plano L 295mm An 195mm		
Para modelos:	L100, L80		

			
1			
código	510002	referencia	30Q3280
descripción	filtro plano ø 50mm H 95mm L 383mm An 136mm		
Para modelos:	KD100, KD100A, KD100PSD, LP151		



			
1			
código	511439	referencia	30G0150
descripción	filtro rectangular H 42mm L 114mm An 104mm		
Para modelos:	L100, L80		

			
1			
código	511438	referencia	30Q2120
descripción	filtro rectangular H 70mm L 160mm An 145mm		

			
1			
código	505268	referencia	30Q1440
descripción	filtro redondo ø 184mm H 103mm inox		
Para modelos:	LC100		

			
1			
código	516079	referencia	35Q9940
descripción	filtro redondo ø 508mm H 55mm		
Para modelos:	LT10R, LT20F, LT25F		

tubos de rebose

			
1			
código	517175	referencia	3018870
descripción	tubo de rebose L 107mm ø 28mm		
Para modelos:	KD40		

			
1			
código	519266	referencia	33D2360
descripción	tubo de rebose L 115mm		

			
1			
código	519378	referencia	33D3080
descripción	tubo de rebose L 115mm ø 28mm		
Para modelos:	LF50E, LF50EM, LP70		

			
1			
código	516252	referencia	33D0390
descripción	tubo de rebose L 120mm ø 29mm		
Para modelos:	LT10R, LT20F, LT25F		

			
1			
código	519387	referencia	33D0341
descripción	tubo de rebose L 185mm ø 36mm		
Para modelos:	L40, L60		

			
1			
código	517185	referencia	33D3350
descripción	tubo de rebose L 185mm ø 40mm		
Para modelos:	KD100, KD100A, KD100PSD, KN50, KN50M, KN50MPS, KN50PS, KN50PSD, KN50PSDD, KN80, KN80PS, LP70		
accesorios para	517185		
	código	517189	referencia
			37Q5140
	junta ø 28mm D1 ø 40mm espesor 6mm		

			
1			
código	517186	referencia	33D3360
descripción	tubo de rebose L 210mm ø 40mm		
Para modelos:	KD100, KD100A, KD100PSD, KD60, KD60E, KD60EAT, KD60M, KD60MA, KD60ME, KD6EATSD, KD85, KD85A, KD85E, KD85EA, KD85EAT, KD85EATS, KD85EPS, KD85EPSA, KD85PS, KD85PSA, KN1100, KN1100SD, KN11PSDD, KN800, KN800PSD, LP151		
accesorios para	517186		
	código	517189	referencia 37Q5140
	junta ø 28mm D1 ø 40mm espesor 6mm		

			
1			
código	516081	referencia	33D0140
descripción	tubo de rebose L 223mm ø 30mm		
Para modelos:	F60P, F60PR, F80PR, L45		

			
1			
código	510679	referencia	33D2320
descripción	tubo de rebose L 245mm ø 35mm		
Para modelos:	LC100, LC80		

			
1			
código	517357	referencia	3056130
descripción	tubo de rebose L 420mm ø 44mm		
Para modelos:	KD130, KD130A, KD130E, KD130EAT		
accesorios para	517357		
	código	517189	referencia 37Q5140
	junta ø 28mm D1 ø 40mm espesor 6mm		

			
1			
código	519390	referencia	33D2880
descripción	tubo de rebose L 430mm ø 35mm		
Para modelos:	C165D, C165S, C165VD, C165VS, C207D, C207S, C207VD, C207VD-VERS.2006, C207VS, C207VS-VERS.2006, C304AD, C304AS, C304AVD, C304AVD-VERS.2006, C304AVS, C304AVS-VERS.2006, C304D, C304S, C304VD, C304VD-VERS.2006, C304VS, C304VS-VERS.2006, C92VD-VERS.2006, C92VS-VERS.2006, CS243D, CS243S, CS243VD, CS243VD-VERS.2006, CS243VS, CS243VS-VERS.2006, CS370AD, CS370AS, CS370AVD, CS370AVD-VERS.2006, CS370AVS, CS370A-VS-VERS.2006, CS370D, CS370S, CS370VD, CS370VD-VERS.2006, CS370VS, CS370VS-VERS.2006, CS466AD, CS466AD-VERS.2006, CS466AS, CS466AS-VERS.2006, CS466AVD, CS466AVD-VERS.2006, CS466AVS, CS466AVS-VERS.2006...(Otros modelos se puede ver en la tienda web)		

			
1			
código	519381	referencia	33D0050
descripción	tubo de rebose L 430mm ø 42mm		
Para modelos:	L100, L80		

			
1			
código	517177	referencia	3081150
descripción	tubo de rebose L 96mm ø 28mm		
Para modelos:	KD37		

contenedores

recipientes de dosificación

			
1			
código	361736	referencia	36A4160
descripción	recipiente abrillantador		
Para modelos:	LF50, LF50E, LF50EM, LF50EM-VERS.122012, LF50E-VERS.122012, LF50E-VERS.2007		

			
1			
código	519380	referencia	33D0660
descripción	recipiente abrillantador		
Para modelos:	F60P, F60PR, F60T, F80P, F80PR, L45		



calentadores de agua

calentadores de agua para lavavajillas



1

código	516163	referencia	34A0700
descripción	calentador de agua		
Para modelos:	LT10R, LT20F, LT25F		



1

código	517302	referencia	34A2560
descripción	calentador de agua con aislamiento ø 160mm L 500mm		
Para modelos:	KD100, KD100A, KD100PSD, KD130, KD130A, KD85, KD85A, KD85E, KD85EA, KD85EAT, KD85EATS, KD85EPS, KD85EPSA, KD85PS, KD85PSA, KN1100, KN1100SD, KN11PSDD, KN800, KN800PSD, LP151		
accesorios para	517302		
	código	referencia	
	517337		—
	esterilla aislante calentador de agua ø 160mm		



1

código	517294	referencia	3022510
descripción	calentador de agua ø 113mm L 320mm		
Para modelos:	KD37, KD37PS, KD37-VERS.112009, KN35, KN37PS		



1

código	517295	referencia	3023900
descripción	calentador de agua ø 113mm L 370mm		
Para modelos:	KD40, KD40PS, KD40-VERS.112009, KN40, KN40PS, KN40PSD		



1

código	519022	referencia	34A1950
descripción	calentador de agua ø 150mm L 400mm		
Para modelos:	LF50, LF50E, LF50EM		

recambios y accesorios



1

código	691742	referencia	3120030
descripción	arandela ø ext. 30		
Para modelos:	FCV241G-CSA, FCV241GDM-CSA, FCV241GDS-CSA, L80		

mecanismos de capota para lavavajillas

pernos



1

código	510595	referencia	3100100
descripción	perno rosca M6x1 para manilla de campana		
Para modelos:	L100, L80		

casquillos



1

código	524445	referencia	35Z0770
descripción	casquillo L 22mm para barra de asidero ø 12mm		
Para modelos:	L100, L80		



1

código	524446	referencia	35Z4410
descripción	casquillo L 35mm para barra de asidero ø 8mm		



1

código	519205	referencia	36C3560
descripción	casquillo mecanismo de campana		
Para modelos:	LC100, LC100-VERS.2001, LC130, LC130-VERS.2001, LC80		



			
1			
código	512423	referencia	N/A
descripción	casquillo para manilla de campana		

soporte de muelle			
			
1			
código	519243	referencia	36H0450
descripción	casquillo para portamuelles mecanismo de campana		
Para modelos:	LC100, LC100-VERS.2001, LC130, LC130-VERS.2001, LC80		



			
1			
código	516094	referencia	36G0210
descripción	soporte de muelle		
Para modelos:	L100, L80		

barras guía			
			
1			
código	517378	referencia	3036440
descripción	barra guía L 650mm pos. de montaje izquierdo para mecanismos de capota espesor 25mm		
Para modelos:	KD100, KD100A, KD100PSD, KD130, KD130A, KD130E, KD130EAT		

			
1			
código	513019	referencia	3036430
descripción	barra guía L 695mm pos. de montaje derecho espesor 25mm		
Para modelos:	KD100, KD100A, KD100PSD, KD130, KD130A, KD130E, KD130EAT		

otros			
			
1			
código	510864	referencia	N/A
descripción	casquillo para portamuelles mecanismo de campana		



cámaras de aire			
cámaras de aire			
			
1			
código	510344	referencia	33D0360
descripción	cámara de aire		
Para modelos:	L100, L40, L40S, L60, L80		
accesorios para	510344		
	código	361182	referencia 3117580
	tuerca rosca 1/4" H 5mm latón niquelado EC 17 UE 1 pzs		
	código	511512	referencia 3150410
	junta tórica EPDM espesor 2.62mm int.ø 18.72mm UE 10 pzs		

			
1			
código	511450	referencia	33M0220
descripción	cámara de aire		
Para modelos:	F60P, F60PR, F60T, F80P, F80PR, L45		
accesorios para	511450		
	código	511197	referencia 3151770
	junta L 46mm An 33mm para cámara de aire		

			
1			
código	516241	referencia	3060029
descripción	cámara de aire		
accesorios para	516241		
	código	528485	referencia —
	junta tórica EPDM espesor 1.78mm int.ø 6.07mm UE 1 pzs		



			
1			
código	519263	referencia	33M0510
descripción	cámara de aire		
Para modelos:	CS243D, CS243S, CS243VD, CS243VS, CS370AD, CS370AS, CS370AVD, CS370AVS, CS370D, CS370S, CS370VD, CS370VS, CS466AD, CS466AS, CS466AVD, CS466AVS, CS466D, CS466S, CS466VD, CS466VS, LF50, LF50E, LF50EM, LF50EMPS, LF50E-VERS.2007, LP70		
accesorios para	519263		
	código	519057	referencia
			—
	tuerca rosca 3/8" EC 25 H 6mm latón		
	código	519114	referencia
			3151890
	junta plana goma ø ext. 25mm int.ø 16.5mm espesor 2mm UE 1 pzs		

			
1			
código	519319	referencia	33D1390
descripción	cámara de aire		
Para modelos:	C165D, C165S, C165VD, C165VS, C207D, C207D-VERS.2006, C207S, C207S-VERS.2006, C207VD, C207VD-VERS.2006, C207VS, C207VS-VERS.2006, C304AD, C304AD-VERS.2006, C304AS, C304AS-VERS.2006, C304AVD, C304AVD-VERS.2006, C304AVS, C304AVS-VERS.2006, C304D, C304D-VERS.2006, C304S, C304S-VERS.2006, C304VD, C304VD-VERS.2006, C304VS, C304VS-VERS.2006, C92D-VERS.2006, C92S-VERS.2006, C92VD-VERS.2006, C92VS-VERS.2006, CS243D, CS243D-VERS.2006, CS243S, CS243S-VERS.2006, CS243VD, CS243VD-VERS.2006, CS243VS, CS243VS-VERS.2006, CS370AD, CS370AD-VERS.2006, CS370AS, CS370AS-VERS.2006, CS370AVD, CS370AVD-VERS.2006, CS370AVS, CS370AVS-VERS.2006, CS370D, CS370D-VERS.2006...(Otros modelos se puede ver en la tienda web)		
accesorios para	519319		
	código	519057	referencia
			—
	tuerca rosca 3/8" EC 25 H 6mm latón		
	código	519114	referencia
			3151890
	junta plana goma ø ext. 25mm int.ø 16.5mm espesor 2mm UE 1 pzs		

			
1			
código	517168	referencia	33D3330
descripción	cámara de aire H 56mm		
accesorios para	517168		
	código	517173	referencia
			37Q5130
	junta plana FIBER ø ext. 14mm int.ø 8mm espesor 1.5mm UE 1 pzs		
	código	517174	referencia
			3110050 33Q6470
	tuerca rosca M8 H 6.5mm EC 13 inox DIN/ISO DIN 934 / ISO 4032/8673 UE 1 pzs		

			
1			
código	517308	referencia	33D3320
descripción	cámara de aire H 65mm		
Para modelos:	KD100, KD100A, KD100PSD, KN35, KN37, KN37PS, KN40, KN40PS, KN40PSD, LP151		

accesorios para cámaras de aire

			
1			
código	511385	referencia	35Z0050
descripción	brida L 46mm An 32mm para cámara de aire		
Para modelos:	F60P, F60PR, F60T, F80P, F80PR, L45		

			
1			
código	511197	referencia	3151770
descripción	junta L 46mm An 33mm para cámara de aire		
Para modelos:	F60P, F60PR, F60T, F80P, F80PR, L45		

mecánicas para lavavajillas de cinta transportadora

			
1			
código	691638	referencia	36G7550
descripción	dedo de transporte		
Para modelos:	C165D, C165S, C165VD, C165VS, C207D, C207D-VERS.2006, C207S, C207S-VERS.2006, C207VD, C207VD-VERS.2006, C207VS, C207VS-VERS.2006, C304AD, C304AD-VERS.2006, C304AS, C304AS-VERS.2006, C304AVD, C304AVD-VERS.2006, C304AVS, C304AVS-VERS.2006, C304D, C304D-VERS.2006, C304S, C304S-VERS.2006, C304VD, C304VD-VERS.2006, C304VS, C304VS-VERS.2006, C92D-VERS.2006, C92S-VERS.2006, C92VD-VERS.2006, C92VS-VERS.2006, CAD, CAS, CS243D, CS243D-VERS.2006, CS243S, CS243VD, CS243VD-VERS.2006, CS243VS, CS243VS-VERS.2006, CS370AD, CS370AD-VERS.2006, CS370AS, CS370AS-VERS.2006, CS370AVD, CS370AVD-VERS.2006, CS370AVS, CS370AVS-VERS.2006, CS370D...(Otros modelos se puede ver en la tienda web)		

bloqueos antirretorno

bloqueos antirretorno



código	504140	referencia	33D0650 33D2100 33D2330
---------------	--------	-------------------	-------------------------------

descripción bloqueo antirretorno



código	516101	referencia	33D0650 33D2330
---------------	--------	-------------------	--------------------

descripción bloqueo antirretorno lavavajillas tubo ø 12mm

Para modelos: C165D, C165S, C207D, C207S, C304AD, C304AS, C304D, C304S, CS243D, CS243S, CS243VD, CS243VS, CS370AD, CS370AS, CS370AVD, CS370AVS, CS370D, CS370S, CS370VD, CS370VS, CS466AD, CS466AS, CS466AVD, CS466AVS, CS466D, CS466S, CS466VD, CS466VS, F60P, KD100, KD100PSD, KD130, KD130E, KD37, KD40, KD40EPSD, KD40LEPS, KD40LSPS, KD40LUX, KD40LUXE, KD60, KD60M, KD60MPS, KD60PS, KD60PSD, KD85, KD85PS, L100, L45, L80...(Otros modelos se puede ver en la tienda web)

repuestos para 516101

código	506367	referencia	—
---------------	--------	-------------------	---

descripción junta plana goma ø ext. 40mm int.ø 28mm espesor 1.8mm UE 1 pzs

otros



código	506160	referencia	3120050
---------------	--------	-------------------	---------

descripción arandela int.ø 8.6mm ø ext. 16mm espesor 1.5mm inox UE 1 pzs

Para modelos: 091FR1EX, 091FR7GS, 091FR7GX, BRE21HD, BRE31HD, FM1011E2-VERS.2006, FM1011E3-VERS.2006, FM1011G2-VERS.2006, FM1011G3-VERS.2006, FM1221E2-VERS.2006, FM1221E3-VERS.2006, FM1221G2-VERS.2006, FM1221G3-VERS.2006, FM611E2-VERS.2006, FM611E3-VERS.2006, FM611G2-VERS.2006, FM611G3-VERS.2006, FM721E3-VERS.2006, FM721G3-VERS.2006, FX101E2C, FX101E3C, FX101G2C, FX101G3C, FX10E2CR, FX10E3CR, FX10G2CR, FX10G3CR, FX122E2C, FX122E3, FX122E3C, FX122E3T, FX122E3T-VERS.022014, FX122G2C, FX122G3, FX122G3C, FX122G3T, FX122G3T-VERS.022014, FX12E3CT, FX12E3CT-VERS.022014, FX12G3CT, FX12G3CT-VERS.022014, FX61E2C, FX61E2CR, FX61E3CR, FX61G2C, FX61G3CR, FX61G3CR, FX82E2C, FX82E3C...(Otros modelos se puede ver en la tienda web)

COMPONENTES ESPECÍFICOS ANGELO-PO

macánica de puertas

pernos



código	514283	referencia	36D7060 36D7061 36D7062
---------------	--------	-------------------	-------------------------------

descripción perno con parte plana 7mm ø 10mm L 20mm para puerta

Para modelos: BX101E, BX101E-VERS.122013, BX101G, BX101G-VERS.122013, BX122E, BX122E-VERS.122013, BX122G, BX122G-VERS.122013, BX61E, BX61E-VERS.122013, BX61G, BX61G-VERS.122013, BX82E, BX82E-VERS.122013, BX82G, BX82G-VERS.122013, FC101, FC1011E, FC1011G, FC101E, FC1221E, FC1221G, FC241, FC241E, FC241G, FC61, FC611E, FC611G, FC61E, FCV101, FCV101-CSA, FCV101DM, FCV101DM-CSA, FCV101DS, FCV101DS-CSA, FCV101E, FCV101EDM, FCV101EDM-UL, FCV101EDS, FCV101EDS-UL, FCV141, FCV141-CSA, FCV141DM, FCV141DM-CSA, FCV141DS, FCV141DS-CSA, FCV141E, FCV141EDM, FCV141EDS, FCV241...(Otros modelos se puede ver en la tienda web)

muelles

resortes enrollados



código	519340	referencia	36G8430
---------------	--------	-------------------	---------

descripción resorte enrollado

Para modelos: LP124, LP124S-VERS.052006, LP124V, LP124-VERS.052006, LP124VS-VERS.052006, LP124V-VERS.052006

placas de fricción



código	518584	referencia	36M1230
---------------	--------	-------------------	---------

descripción placa de fricción

bisagras



código	516089	referencia	36G7400
---------------	--------	-------------------	---------

descripción bisagra a resorte bisagra a resorte

Para modelos: LT10R, LT20F, LT25F



			
1			
código	510593	referencia	35S1980
descripción	bisagra de puerta		
Para modelos:	L40, L40S, L60		
accesorios para	510593		
	código	referencia	3190130
	perno de puerta ø 8mm L 42mm		



			
1			
código	510594	referencia	3190130
descripción	perno de puerta ø 8mm L 42mm		
Para modelos:	L40, L40S, L60		

árboles de puerta			
			
1			
código	695575	referencia	3011520
descripción	para árbol de puerta ø 10mm L 458mm máquina de hielo		
Para modelos:	PG23C, PG24CW, PG30C, PG31CW		

cierres			
			
1			
código	510209	referencia	36M0020
descripción	cierres de puerta		
Para modelos:	L40, L40S, L60		
accesorios para	510209		
	código	referencia	36M0030
	contrapieza contrapieza		

			
1			
código	517276	referencia	3030100
descripción	cierres de puerta cierre		
accesorios para	517276		
	código	referencia	—
	junta para cierre		
	código	referencia	—
	contrapieza retén		

			
1			
código	519247	referencia	31W0061
descripción	cierres de puerta cierre de puerta		
Para modelos:	F60P, F60PR, F60T, F80P, F80PR, L45, LF50, LF50E, LF50EM, LF50EMPS, LF50EMPS-VERS.122012, LF50EM-VERS.122012, LF50E-VERS.122012, LF50E-VERS.2007		
accesorios para	519247		
	código	referencia	—
	tuerca rosca M12x1,75 H 4mm EC 16 inox UE 1 pzs para cierre de enganche		

			
1			
código	510210	referencia	36M0030
descripción	contrapieza contrapieza		
Para modelos:	L40, L40S, L60		
accesorios para	510210		
	código	referencia	36M0020
	cierres de puerta		

otros			
			
1			
código	504435	referencia	3152010
descripción	junta plana plástico ø ext. 18mm int.ø 9.5mm espesor 2.5mm para bisagra de puerta batiente UE 1 pzs		

uniones roscadas



1

código	505506	referencia	33Q0220
descripción	tuerca		



1

código	505505	referencia	33Q2160
descripción	tuerca rosca 1¼" EC 55 plástico		

Para modelos: C165D, C165S, C165VD, C165VS, C207D, C207D-VERS.2006, C207S, C207S-VERS.2006, C207VD, C207VD-VERS.2006, C207VS, C207VS-VERS.2006, C304AD, C304AD-VERS.2006, C304AS, C304AS-VERS.2006, C304AVD, C304AVD-VERS.2006, C304AVS, C304AVS-VERS.2006, C304D, C304D-VERS.2006, C304S, C304S-VERS.2006, C304VD, C304VD-VERS.2006, C304VS, C304VS-VERS.2006, C92D-VERS.2006, C92S-VERS.2006, C92VD-VERS.2006, C92VS-VERS.2006, CS243D, CS243D-VERS.2006, CS243S, CS243S-VERS.2006, CS243VD, CS243VD-VERS.2006, CS243VS, CS243VS-VERS.2006, CS370AD, CS370AD-VERS.2006, CS370AS, CS370AS-VERS.2006, CS370AVD, CS370AVD-VERS.2006, CS370AVS, CS370AVS-VERS.2006, CS370D, CS370D-VERS.2006...(Otros modelos se puede ver en la tienda web)



1

código	519008	referencia	N/A
descripción	tuerca rosca 2¼" UE 1 pzs		



1

código	506278	referencia	33Q4700
descripción	tuerca rosca M26x1,5 H 15mm EC 32 plástico UE 1 pzs 12		
Para modelos:	F60PR, F60T, F80P, F80PR		

cortinas

cortinas



1

código	533016	referencia	36Z0720
descripción	cortina An 640mm H 410mm plástico espesor 1.5mm sistemas de lavado		

sistemas de lavado y aclarado



1

código	510626	referencia	33T1120 33T1121
descripción	boquilla de aclarado ø 0,7/1,5mm rosca 1/8" M		
Para modelos:	L100, L40, L40S, L60, L80		



1

código	519388	referencia	33T0970
descripción	boquilla de lavado		



1

código	519389	referencia	33T0260
descripción	boquilla de lavado		



1



código	505516	referencia	30Z0240 6001920
descripción	brazo de aclarado L 495mm boquillas 4 completo		
Para modelos:	L100, L40, L40S, L60, L80		
repuestos para	505516		



código	505502	referencia	36D0720
descripción	perno de aclarado		

Continúa en la página siguiente



repuestos para 505516				
	código	510626	referencia	33T1120 33T1121
boquilla de aclarado ø 0,7/1,5mm rosca 1/8" M				
	código	518075	referencia	36Q0180
tapa terminal rosca 1/4" EC 14				
	código	524877	referencia	36D0740
casquillo para brazo de aclarado ø 20mm int.ø 16mm H 8mm ø ext. 26mm				
	código	691730	referencia	33Q0510
tuerca moleteada rosca M10x1,5 ø 36mm H 3.5mm acero inoxidable				

	1			
código	519047	referencia	36U0740	
descripción	brida			
Para modelos:	LF50			

	1			
código	517095	referencia	3021600	
descripción	brida ø 60mm			

	1			
código	517341	referencia	33Q6600	
descripción	casquillo int.ø 16mm ø ext. 48mm			
Para modelos:	KD100, KD100A, KD100PSD, KD130, KD130A, KD130E, KD130EAT, KN1100, KN1100SD, KN11PSDD, LP151, N100D, N100S, N100VD, N100VS, N38D, N38S, N38VD, N38VS, N42D, N42S, N42VD, N42VS, N50D, N50S, N50VD, N50VS, N66D, N66S, N66VD, N66VS, N70D, N70S, N70VD, N70VS, N85D, N85S, N85VD, N85VS			

	1			
código	524877	referencia	36D0740	
descripción	casquillo para brazo de aclarado ø 20mm int.ø 16mm H 8mm ø ext. 26mm			
Para modelos:	L100, L40, L40S, L60, L80			

	1			
código	510053	referencia	36G8460	
descripción	casquillo para brazo de aclarado ø 24mm H 5.7mm			
Para modelos:	LP124, LP124S-VERS.052006, LP124V, LP124-VERS.052006, LP124VS-VERS.052006, LP124V-VERS.052006, LP84, LP84S-VERS.052006, LP84V, LP84-VERS.052006, LP84VS-VERS.052006, LP84V-VERS.052006			

	1			
código	519088	referencia	36G9110	
descripción	casquillo para brazo de lavado			

	1			
código	519167	referencia	33Q370 33Q3700	
descripción	casquillo para brazo de lavado			
Para modelos:	LP124, LP124S-VERS.052006, LP124V, LP124-VERS.052006, LP124VS-VERS.052006, LP124V-VERS.052006, LP84, LP84S-VERS.052006, LP84V, LP84-VERS.052006, LP84VS-VERS.052006, LP84V-VERS.052006			
accesorios para	519167			
	código	519087	referencia	36G8720
tuerca para brazo de lavado				

	1			
código	695590	referencia	31Z0250	
descripción	casquillo para brazo de lavado			
Para modelos:	KD100, KD100A, KD100PSD, KD37, KD37PS, KD37-VERS.112009, KD40PS, KD40-VERS.112009, KD85, KD85A, KD85PS, KD85PSA, KN35, KN37, KN37PS, KN40, KN40PS, KN40PSD			

	1			
código	517333	referencia	33Q5070	
descripción	casquillo rosca M16x1 ø 25mm acero inoxidable			
Para modelos:	L40, L40S, L60			

		
1		
código	505508	referencia
descripción	cojinete para brazo de lavado	

		
1		
código	505507	referencia
descripción	cojinete de brazo de lavado	

		
1		
código	510183	referencia
descripción	contrasoporte para boquilla de aclarado	

		
1		
código	510181	referencia
descripción	contrasoporte para boquilla de lavado	

		
1		
código	505510	referencia
descripción	cruzeta de brazo de lavado	

		
1		
código	519122	referencia
descripción	junta plana para brazo de aclarado	
Para modelos:	C165D, C165S, C207D, C207S, C304AD, C304AS, C304D, C304S, CS243D, CS243S, CS243VD, CS243VS, CS370AD, CS370AS, CS370AVD, CS370AVS, CS370D, CS370S, CS370VD, CS370VS, CS466AD, CS466AS, CS466AVD, CS466AVS, CS466D, CS466S, CS466VD, CS466VS, LC100, LC100-VERS.2001, LC130, LC130-VERS.2001, LC80, N303D, N303S, N303VD, N303VS, N354D, N354S, N354VD, N354VS, N506D, N506S, N506VD, N506VS, N607D, N607S, N607VD, N607VS, N760D...(Otros modelos se puede ver en la tienda web)	

		
1		
código	532536	referencia
descripción	junta tórica para boquilla de aclarado	
Para modelos:	C207D-VERS.2006, C207S-VERS.2006, C207VD-VERS.2006, C207VS-VERS.2006, C304AD-VERS.2006, C304AS-VERS.2006, C304AVD-VERS.2006, C304AVS-VERS.2006, C304D-VERS.2006, C304S-VERS.2006, C304VD-VERS.2006, C304VS-VERS.2006, C92D-VERS.2006, C92S-VERS.2006, C92VD-VERS.2006, C92VS-VERS.2006, CS243D-VERS.2006, CS243S-VERS.2006, CS243VD-VERS.2006, CS243VS-VERS.2006, CS370AD-VERS.2006, CS370AS-VERS.2006, CS370AVD-VERS.2006, CS370AVS-VERS.2006, CS370D-VERS.2006, CS370S-VERS.2006, CS370VD-VERS.2006, CS370VS-VERS.2006, CS466AD-VERS.2006, CS466AS-VERS.2006, CS466AVD-VERS.2006, CS466AVS-VERS.2006, CS466D-VERS.2006, CS466S-VERS.2006, CS466VD-VERS.2006, CS466VS-VERS.2006, LC100, LC100-VERS.2001, LC130, LC130-VERS.2001, LC80, LF50, LF50E, LF50EM, LF50EMPS	

		
1		
código	505502	referencia
descripción	perno de aclarado	
Para modelos:	L100, L40, L40S, L60, L80	

		
1		
código	517332	referencia
descripción	perno de aclarado	
Para modelos:	L100, L40, L60, L80	

		
1		
código	541505	referencia
descripción	pieza de empalme rosca 1/2" ø 14mm	
Para modelos:	L100, L40, L60, L80	

		
1		
código	511911	referencia
descripción	soporte de brazo de lavado	
accesorios para	511911	
	código	510884
	referencia	—
	descripción	junta





 <p>1</p>			
código	511912	referencia	33M0820
descripción	soporte de brazo de lavado		
accesorios para	511912		
	código	referencia	—
	 <p>1</p> junta		

 <p>1</p>			
código	504779	referencia	33Q3380
descripción	soporte de brazo de lavado ø 43mm H 36.5mm M4		
Para modelos:	L100, L40, L40S, L60, L80		

 <p>1</p>			
código	511561	referencia	3021590
descripción	soporte de brazo de lavado pos. de montaje abajo H 103mm		
Para modelos:	KD40		

 <p>1</p>			
código	518075	referencia	36Q0180
descripción	tapa terminal rosca 1/4" EC 14		
Para modelos:	L100, L40, L40S, L60, L80		

 <p>1</p>			
código	519085	referencia	33Q3710
descripción	tornillo de cabeza moleteada ø 34mm rosca M6		
Para modelos:	LC100, LC100-VERS.2001, LC130, LC130-VERS.2001, LC80, LF50, LF50E, LF50EM, LF50EMPS, LF50EMPS-VERS.122012, LF50EM-VERS.122012, LF50E-VERS.122012, LF50E-VERS.2007, LP124, LP124V, LP84, LP84V		

 <p>1</p>			
código	524804	referencia	3036730
descripción	tornillo de cabeza moleteada rosca M5 rosca L 7mm ø 30mm H 5mm inox UE 1 pzs		
Para modelos:	KD100, KD100A, KD100PSD, KD130, KD130A, KD130E, KD130EAT, KD40EPSD, KD40LEPS, KD40LUXE, KD60, KD60E, KD60EAT, KD60M, KD60MA, KD60ME, KD60MPS, KD60MPSA, KD60PS, KD60PSD, KD6E-ATSD, KD85, KD85A, KD85E, KD85EA, KD85EAT, KD85EATS, KD85EPS, KD85EPSA, KD85PS, KD85PSA, KN1100, KN1100SD, KN11PSDD, KN80, KN80PS, LP151, LP202, LP202HC, LP302, LP302HC, LP402, LP402HC, LP402V, LP70		
accesorios para	524804		
	código	referencia	3036720 33q6400
	 <p>1</p> perno de aclarado sistemas de lavado ø 14mm H 38mm rosca 1/4"		

 <p>1</p>			
código	519201	referencia	36G9080
descripción	tubo de aclarado		
Para modelos:	LC80, LF50		

 <p>1</p>			
código	519006	referencia	33Q4220
descripción	tuerca		

 <p>1</p>			
código	519087	referencia	36G8720
descripción	tuerca para brazo de lavado		
Para modelos:	LC100, LC100-VERS.2001, LC130, LC130-VERS.2001, LP124, LP124S-VERS.052006, LP124V, LP124-VERS.052006, LP124VS-VERS.052006, LP124V-VERS.052006, LP84, LP84S-VERS.052006, LP84V, LP84-VERS.052006, LP84VS-VERS.052006, LP84V-VERS.052006		

 <p>1</p>			
código	510338	referencia	N/A
descripción	tuerca de racor dosificador rosca 1/2" ø 32mm H 15mm para dosificadoras		



1

código	691730	referencia	33Q0510
descripción	tuercas moleteada rosca M10x1,5 ø 36mm H 3.5mm acero inoxidable		
Para modelos:	L100, L40S, L60, L80		

para unidades de vacío

cintas de PTFE



1

código	692155	referencia	304184
descripción	cinta de PTFE An 50mm UE 1m		

pomos

pomos universales



1

código	111934	referencia	36M0700
descripción	pomo termostato T máx 90°C ø 50mm eje ø 6x4,6mm parte plana arriba negro margen de trabajo 30-90°C ángulo de rotación 270°		
Para modelos:	L100, L40, L40S, L60, L80		
accesorios para	111934		
	código	110135	referencia —
	roseta pomo hasta ø 52mm		



1

código	110111	referencia	36M0590
descripción	pomo interruptor 5 posiciones ø 60mm eje ø 6x4,6mm parte plana arriba negro		



1

código	110117	referencia	36M0750
descripción	pomo reg. de energía 1-3 T máx°C ø 60mm eje ø 6x4,6mm parte plana arriba negro		
repuestos para	110117		
	código	112495	referencia —
	muelle de pomo L 10.5mm An 8.5mm UE 1 pzs		



1

código	110116	referencia	3110114 3110117
descripción	pomo termostato T máx 110°C ø 60mm eje ø 6x4,6mm parte plana arriba negro margen de trabajo 30-110°C ángulo de rotación 270°		



1

código	110114	referencia	36M0610
descripción	pomo termostato T máx 300°C ø 60mm eje ø 6x4,6mm parte plana arriba negro margen de trabajo 50-300°C ángulo de rotación 270°		

pomos personalizados para fabricantes

ANGELO PO



1

código	110899	referencia	6300489
descripción	pomo grifo de gas con llama piloto T máx°C ø 77mm eje ø 10x9mm parte plana arriba rojo		
Para modelos:	0A0FAS, 0A0FAVA, 0A0GRG, 0A1CP1G, 0B0FAS, 0B1CP1G, 0D0FAS, 0D0FAVA, 0D0GRG, 0D1CP1G, 1A0FA2, 1A0FA5, 1A0FAB, 1A0FAS, 1A0FAS2, 1A0GRG, 1A0TP0, 1A1CP1G, 1A1CP2G, 1A1FA2G, 1A1FA5G, 1A1FABG, 1A1FAS2G, 1A1FASG, 1A1PD1G, 1A1PD2G, 1A1PI1G, 1A1PI1GA, 1A1TP0G, 1A1TP0G-VERS.2002, 1B0FAS, 1B0FAS2, 1B0TP0, 1B1FAS2G, 1B1FASG, 1D0FA2, 1D0FA5, 1D0FAB, 1D0FAS, 1D0FAS2, 1D0GRG, 1D0TP0, 1D1CP1G, 1D1CP2G, 1D1FA2G, 1D1FA5G, 1D1FABG, 1D1FAS2G, 1D1FASG, 1D1PD1G...(Otros modelos se puede ver en la tienda web)		



1

código	112192	referencia	6300518 6300521
descripción	pomo grifo de gas con llama piloto T máx°C°C ø 77mm eje ø 8x6,5mm parte plana arriba rojo		
Para modelos:	0A0FA1, 0A0FA4, 0A0FAA, 0D0FA1, 0D0FA4, 0D0FAA, 0G0FA0, 0G1CP1G, 0G1CP1G-VERS.2004, 1A0FA1, 1A0FA2, 1A0FA4, 1A0FA5, 1A0FAA, 1A0FAB, 1A1FA1G, 1A1FA2G, 1A1FA4G, 1A1FA5G, 1A1FAAG, 1A1FABG, 1D0FA1, 1D0FA2, 1D0FA4, 1D0FA5, 1D0FAA, 1D0FAB, 1D1FA1G, 1D1FA2G, 1D1FA4G, 1D1FA5G, 1D1FAAG, 1D1FABG, 1G0FA0, 1G0GRG, 1G0TP0, 1G1CP1G, 1G1CP1G-VERS.2004, 1G1CP2G, 1G1CP2G-VERS.2004, 1G1FA0E, 1G1FA0EV, 1G1FA0G, 1G1FA0GV, 1G1FAPG, 1G1TPOG, 2A0FA1, 2A0FA4, 2A0FAA, 2A1FA1G...(Otros modelos se puede ver en la tienda web)		



1

código	110927	referencia	6300481
descripción	pomo interruptor 0-1-0-1 T máx°C°C ø 77mm eje ø 6x4,6mm parte plana arriba rojo		
Para modelos:	0A1FR1ED, 0A1FR1GD, 0A1FR1GD-VERS.2004, 0B1FR1GD, 0D1FR1ED, 0D1FR1GD, 0D1FR1GD-VERS.2004, 0G0FR3ED, 0G1FR3GD, 1A1FR2ED, 1A1FR2GD, 1A1FR2GD-VERS.2004, 1A1PI2G, 1A1PI2GA, 1D1FR2ED, 1D1FR2GD, 1D1FR2GD-VERS.2004, 1D1PI2G, 1D1PI2GA, 1G1FR4GD		



1

código	110908	referencia	6300485
descripción	pomo interruptor 5 posiciones T máx°C°C ø 77mm eje ø 6x4,6mm parte plana arriba rojo		
Para modelos:	0A0PE4, 0A1CP1E, 0D0PE4, 0D1CP1E, 0G1CP1E, 0G1CP1E-VERS.2004, 1A0PE4, 1A1PE4E, 1A1PEFE, 1A1PI2E, 1A1PI2EA, 1D0PE4, 1D1PE4E, 1D1PI2E, 1D1PI2EA, 1G1PI1E		



1

código	112188	referencia	6300556
descripción	pomo interruptor 7 posiciones T máx°C°C eje ø 6x4,6mm parte plana arriba rojo		
Para modelos:	0G0PE1, 0G0PE2, 0G1PE2, 1G0PE1, 1G0PE2, 1G1PE1E, 1G1PE1EV, 1G1PE2, 1G1PE2E, 1G1PE2EV, 2G0PE1, 2G0PE2, 2G1PE1E, 2G1PE1EV, 2G1PE2E, 2G1PE2EV		
repuestos para	112188		
	código	550965	referencia 3170290
	muelle de pomo ø 6x4,6mm UE 1 pzs		



1

código	112275	referencia	6300522
descripción	pomo interruptor 7 posiciones T máx°C°C ø 84mm eje ø 6x4,6mm parte plana arriba rojo		
Para modelos:	60SME		



1

código	110924	referencia	6300486
descripción	pomo termostato de gas T máx 100°C 30-100°C ø 77mm eje ø 8x6,5mm parte plana arriba rojo		
Para modelos:	0A0BMG, 0D0BMG, 1A0BMG, 1D0BMG		



1

código	112191	referencia	6300504
descripción	pomo termostato de gas T máx 280°C 100-280°C eje ø 10x9mm parte plana arriba rojo		
Para modelos:	0A0FT4G, 0A0FT5G, 0B0FT1G, 0B0FT2G, 0B0FT4G, 0B0FT5G, 0D0FT4G, 0D0FT5G, 0G0FT4G, 0G0FT5G, 1A0FT4G, 1A0FT6G, 1B0FT4G, 1B0FT6G, 1D0FT4G, 1D0FT6G, 1G0FT4G, 1G0FT6G		



1

código	112187	referencia	6300488
descripción	pomo termostato de gas T máx 280°C 100-280°C eje ø 8x6,5mm parte plana arriba rojo		
Para modelos:	0A0FT1G, 0A0FT2G, 0A0FT4G, 0A0FT5G, 0D0FT1G, 0D0FT2G, 0D0FT4G, 0D0FT5G, 0G1BR3G, 1A0FT1G, 1A0FT2G, 1A0FT3G, 1A0FT4G, 1A0FT6G, 1D0FT1G, 1D0FT2G, 1D0FT3G, 1D0FT4G, 1D0FT6G, 1G1BR3G		



1

código	112186	referencia	6300553
descripción	pomo termostato de gas T máx 280°C 160-280°C eje ø 8x6,5mm parte plana arriba rojo		
Para modelos:	1G1FA0G, 1G1FA0GV, 1G1FAPG, 1G1TP0G, 2G1FA0G, 2G1FA0GV, 2G1FADG, 2G1FADGV, 2G1FAPG, 2G1TP3G, G1FAGS, G1FAGST		



1

código	112710	referencia	6300510
descripción	pomo termostato de gas T máx 300°C 100-300°C ø 79mm eje ø 8x6,5mm parte plana arriba negro/rojo		
Para modelos:	1A1FA1G, 1A1FA2G, 1A1FA4G, 1A1FA5G, 1A1FAAG, 1A1FABG, 1A1TP0G-VERS.2002, 1B1FAS2G, 1B1FASG, 1D1FA1G, 1D1FA2G, 1D1FA4G, 1D1FA5G, 1D1FAAG, 1D1FABG, 1D1TP0G-VERS.2002, 2A1FA1G, 2A1FA4G, 2A1FAAG, 2A1TP3G, 2A1TP6G, 2A1TPCG, 2D1FA1G, 2D1FA4G, 2D1FAAG, 2D1TP3G, 2D1TP6G, 2D1TPCG, 3A1FA1G, 3A1FA4G, 3A1FAAG, 3D1FA1G, 3D1FA4G, 3D1FAAG		



1

código	112189	referencia	6300503
descripción	pomo termostato de gas T máx 340°C 160-340°C eje ø 10x9mm parte plana arriba rojo		
Para modelos:	0A0FT1G, 0A0FT2G, 0D0FT1G, 0D0FT2G, 0G0FT1G, 0G0FT2G, 1A0FT1G, 1A0FT2G, 1A0FT3G, 1B0FT1G, 1B0FT2G, 1B0FT3G, 1D0FT1G, 1D0FT2G, 1D0FT3G, 1G0FT1G, 1G0FT2G, 1G0FT3G		



1

código	110926	referencia	6300480
descripción	pomo termostato T máx 190°C 110-190°C eje ø 6x4,6mm parte plana arriba rojo margen de trabajo 110-190°C		
Para modelos:	0A1FR1E, 0A1FR1G, 0A1FR1G-VERS.2004, 0A1FR3E, 0A1FR3ED, 0A1FR3G, 0A1FR3GD, 0B1FR1G, 0D1FR1E, 0D1FR1G, 0D1FR1G-VERS.2004, 0D1FR3E, 0D1FR3ED, 0D1FR3G, 0D1FR3GD, 0G0FR3E, 0G1FR3G, 1A1FR2E, 1A1FR2G, 1A1FR2G-VERS.2004, 1A1FR4E, 1A1FR4ED, 1A1FR4G, 1A1FR4GD, 1D1FR2G, 1D1FR2G-VERS.2004, 1D1FR4E, 1D1FR4ED, 1D1FR4G, 1D1FR4GD, 1G0FR4E, 1G1FR4G		



1

código	110923	referencia	6300492
descripción	pomo termostato T máx 270°C 100-270°C eje ø 6x4,6mm parte plana arriba rojo ángulo de rotación 270°		
Para modelos:	0A0FT1E, 0A0FT2E, 0A0FT4E, 0A0FT5E, 0D0FT1E, 0D0FT2E, 0D0FT4E, 0D0FT5E, 0G0FT1E, 0G0FT2E, 0G0FT4E, 0G0FT5E, 0G1FT2E, 0G1FT4E, 1A0FT1E, 1A0FT2E, 1A0FT3E, 1A0FT4E, 1A0FT6E, 1D0FT1E, 1D0FT2E, 1D0FT3E, 1D0FT4E, 1D0FT6E, 1G0FT1E, 1G0FT2E, 1G0FT3E, 1G0FT4E, 1G1FT2E, 1G1FT4E, 1G1FT6E		



1

código	112190	referencia	6300554
descripción	pomo termostato T máx 300°C 80-300°C eje ø 6x4,6mm parte plana arriba rojo		
Para modelos:	1G1FA0E, 1G1FA0EV, 1G1PE1E, 1G1PE1EV, 1G1PE2E, 1G1PE2EV, 2G1PE1E, 2G1PE1EV, 2G1PE2E, 2G1PE2EV		



1

código	110922	referencia	6300484
descripción	pomo interruptor 4 posiciones T máx°C°C ø 65mm eje ø 6x4,6mm parte plana arriba rojo		
Para modelos:	1A1PE4E, 1A1PEFTE, 1A1FBE, 1D1PE4E, 1D1FBE		



1

código	110934	referencia	6300493
descripción	pomo regulador de energía 1-8 T máx°C°C eje ø 6x4,6mm parte plana arriba rojo		
Para modelos:	0G1BR3E, 1A1BR1E, 1A1BR2E, 1A1BR2EA, 1D1BR1E, 1D1BR2E, 1D1BR2EA, 1G1BR3E, 2A1BR1E, 2A1BR2E, 2A1BR2EA, 2A1PI3E, 2D1BR1E, 2D1BR2E, 2D1BR2EA		



			
1			
código	110909	referencia	6300487
descripción	pomo termostato de gas T máx 300°C 100-300°C eje ø 8x6,5mm parte plana arriba		
Para modelos:	1A1FAS2G, 1A1FASG, 1A1TP0G, 1D1FAS2G, 1D1FASG, 1D1TP0G, 2A1FAS2G, 2A1FASG, 2A1TPSG, 2D1FAS2G, 2D1FASG, 2D1TPSG, 3A1FASG, 3D1FASG		

			
1			
código	112637	referencia	3019901 3112000
descripción	pomo agua T máx°C°C ø 72mm eje ø 6x4,6mm parte plana arriba rojo		
Para modelos:	04WCP1EM, 06WCP1GM, 08WCP1GM, 091CP1E, 091CP1G, 0G1CP1EC, 0G1CP1E-VERS.2004, 0G1CP1G-VERS.2004, 191CP1G, 191CP2G, 1G1CP1G-VERS.2004, 1G1CP2G-VERS.2004		

			
1			
código	110933	referencia	6300491
descripción	pomo termostato T máx 270°C 100-270°C eje ø 6x4,6mm parte plana arriba rojo margen de trabajo 100-270°C		
Para modelos:	0G1BR3E, 1A1BR1E, 1A1BR1G, 1A1BR1GA, 1A1BR2E, 1A1BR2EA, 1A1BR2G, 1A1BR2GA, 1D1BR1E, 1D1BR1G, 1D1BR1GA, 1D1BR2E, 1D1BR2EA, 1D1BR2G, 1D1BR2GA, 1G1BR1E, 1G1BR3E, 2A1BR1E, 2A1BR1G, 2A1BR1GA, 2A1BR2E, 2A1BR2EA, 2A1BR2G, 2A1BR2GA, 2D1BR1E, 2D1BR1G, 2D1BR1GA, 2D1BR2E, 2D1BR2EA, 2D1BR2G, 2D1BR2GA		

			
1			
código	112798	referencia	3015731
descripción	pomo grifo de gas con llama piloto T máx°C°C ø 72mm eje ø 10x8mm parte plana arriba rojo		
Para modelos:	06WCP1GM, 08WCP1GM, 08WGRGV, 090FAVA, 090GRG, 091CP1G, 10CP1GA, 10WTPGE, 10WTPGV, 190FAB, 190GRG, 190TP0, 191CP1G, 191CP2G, 191FABG, 191PD1G, 191PD2G, 191PI1G, 191PI1GA, 191PI2G, 191PI2GA, 191TPG, 1G1PD1G, 1G1PI1G, 291PD3G, 291PI3G, 291TPCG		

			
1			
código	110919	referencia	6300483
descripción	pomo termostato T máx 300°C 100-300°C ø 65mm eje ø 6x4,6mm parte plana arriba rojo		
Para modelos:	0M0FT1E, 0M0FT2E, 0M0FT4E, 0M0FT5E, 1A1PE4E, 1A1PEFTE, 1A1FBE, 1D1PE4E, 1D1FBE, 1M0FT1E, 1M0FT2E, 1M0FT3E, 1M0FT4E, 1M0FT5E, 1M0FT6E, 2M0FT1E, 2M0FT2E, 2M0FT3E, 2M0FT4E, 2M0FT5E, 2M0FT6E		

			
1			
código	112636	referencia	3013170 3013171
descripción	pomo grifo de gas con llama piloto T máx°C°C ø 72mm eje ø 8x6,5mm parte plana arriba rojo		
Para modelos:	04WFAAV, 08WFA4E, 08WFA4G, 08WFAAE, 08WFAAG, 08WFAAV, 090FAA, 0G0FA0, 0G1CP1G-VERS.2004, 10WTPGE, 12WFA6E, 12WFA6G, 12WFAAA, 12WFAAE, 12WFAAG, 12WFAAN, 190FA, 190FAA, 190FAB, 190FAD, 191FAAE, 191FAAG, 191FABG, 191FADG, 191FAE, 191FAG, 1G0FA0, 1G0FA0B, 1G0GRG, 1G0TP0, 1G1CP1G-VERS.2004, 1G1CP2G-VERS.2004, 1G1FA0E, 1G1FA0EV, 1G1FA0G, 1G1FA0GV, 1G1FABG, 1G1FAPG, 1G1TP0G, 290FA, 291FAG, 291FAGF, 291TPCG, 2G0FA0, 2G0FA0A, 2G0FA0B, 2G1FA0E, 2G1FA0G, 2G1FA0GV, 2G1FABG...(Otros modelos se puede ver en la tienda web)		

			
1			
código	112193	referencia	6300490
descripción	símbolo para pomo válvulas de gas T máx°C°C ø 65mm eje ø 8x6,5mm parte plana arriba NOVASIT		
Para modelos:	1A1BR1G, 1A1BR1GA, 1A1BR2G, 1A1BR2GA, 1D1BR1G, 1D1BR1GA, 1D1BR2G, 1D1BR2GA, 2A1BR1G, 2A1BR1GA, 2A1BR2G, 2A1BR2GA, 2D1BR1G, 2D1BR1GA, 2D1BR2G, 2D1BR2GA		



1

código	112643	referencia	3015990 3015991
descripción	pomo interruptor 0-10 T máx°C°C ø 72mm eje ø 6x4,6mm parte plana arriba		
Para modelos:	04WVT1IV, 04WVT1IV-VERS.022010, 04WVT2IV, 04WVT2IV-VERS.022010, 08WVT1IV, 08WVT1IV-VERS.112009, 08WVT2IV, 08WVT2IV-VERS.112009, 090VT1I, 090VT1I-VERS.112010, 090VT1W, 090VT1W-VERS.102008, 091VT1I, 091VT1I-VERS.2009, 091VT1W, 091VT2I, 091VT2I-VERS.2009, 0G0VT1I, 0G0VT1I-VERS.112010, 0G0VT1W, 190VT1I, 190VT1I-VERS.112010, 191VT1I, 191VT1I-VERS.2009, 191VT2I, 191VT2I-VERS.2009, 1G0VT1I, 1G0VT1I-VERS.122010		



2

código	112640	referencia	3015850 3015851
descripción	pomo interruptor 0-1-0-1 T máx°C°C ø 72mm eje ø 6x4,6mm parte plana arriba rojo		
Para modelos:	04WFR3ED, 06WFR3GD, 08WFR4ED, 08WGREV, 091FR1ED, 091FR1GD, 091FR3ED, 091FR3GD, 0G0FR3ED, 0G1FR3GD, 10WFR4GD, 190GRE, 191FR2ED, 191FR2GD, 191FR4ED, 191FR4GD, 1G0GRE, 1G1FR4GD, 291PI3G, 2A1PI3G, 2D1PI3G		



1

código	112638	referencia	3020250 3020251
descripción	pomo interruptor 4 posiciones T máx°C°C ø 72mm eje ø 6x4,6mm parte plana arriba rojo		
Para modelos:	08WFA4E, 08WFAAE, 10WTPGE, 12WFA6E, 12WFAAE, 191FAAE, 191FAE, 191PE4E		



1

código	112634	referencia	3015940 3015941
descripción	pomo interruptor 5 posiciones T máx°C°C ø 72mm eje ø 6x4,6mm parte plana arriba rojo		
Para modelos:	04WPE4V, 08WPE4V, 090PE4, 0G1CP1E-VERS.2004, 190PE4, 191PE4E, 191PI2E, 191PI2EA, 1G1PI1E		



1

código	112774	referencia	3144110
descripción	pomo termostato de gas T máx 250°C 100-250°C ø 72mm eje ø 8x6,5mm parte plana arriba rojo		
Para modelos:	0G0FT1G-VERS.032008, 0G0FT2G-VERS.032008, 0G0FT4G-VERS.032008, 0G0FT5G-VERS.032008, 0G0FT7G, 1G0FT1G-VERS.032008, 1G0FT2G-VERS.032008, 1G0FT3G-VERS.032008, 1G0FT4G-VERS.032008, 1G0FT6E, 1G0FT6G-VERS.032008, 1G0FT7G		



1

código	112641	referencia	3010330 3010331
descripción	pomo termostato de gas T máx 270°C 140-270°C ø 72mm eje ø 8x6,5mm parte plana arriba rojo		
Para modelos:	08WFA4G, 08WFAAG, 08WFT1GV, 08WFT2GV, 08WFT3GV, 08WFT4GV, 08WFT6GV, 08WFT7GV, 090FT1G, 090FT2G, 090FT4G, 090FT5G, 090FT7G, 12WFA6G, 12WFAAG, 190FT15G, 190FT1G, 190FT2G, 190FT3G, 190FT42G, 190FT4G, 190FT6G, 190FT72G, 190FT7G, 191FAAG, 191FABG, 191FADG, 191FAG, 191TPG, 1G1BR1G, 291FAG, 291FAGF, 291TPCG, 391FAG		



1

código	112635	referencia	3015831
descripción	pomo termostato T máx 190°C 110-190°C ø 72mm eje ø 6x4,6mm parte plana arriba rojo		
Para modelos:	091FR1E, 091FR1G, 091FR1I, 091FR1I-VERS.032012, 091FR3E, 091FR3G, 091FR7G, 091FR7G-VERS.052012, 0G0FR3E, 0G1FR3G, 191FR2E, 191FR2G, 191FR2I, 191FR2I-VERS.032012, 191FR4E, 191FR4G, 1G0FR4E, 1G1FR4G		



1

código	112797	referencia	3015870 3015871
descripción	pomo termostato T máx 270°C 110-270°C ø 72mm eje ø 6x4,6mm parte plana arriba rojo		
Para modelos:	06WBR3E, 06WFT1EV, 06WFT2EV, 06WFT3EV, 06WFT4EV, 06WFT6EV, 06WFT7EV, 08WFT1EV, 08WFT2EV, 08WFT3EV, 08WFT4EV, 08WFT6EV, 08WFT7EV, 090FT1E, 090FT2E, 090FT4E, 090FT5E, 090FT7E, 091FT1E, 091FT2E, 091FT4E, 091FT5E, 091FT7E, 0G0FT1E, 0G0FT2E, 0G0FT4E, 0G0FT5E, 0G0FT7E, 0G1BR3E, 0G1FT2E, 0G1FT4E, 0G1FT5E, 0G1FT7E, 190FT15E, 190FT1E, 190FT2E, 190FT3E, 190FT42E, 190FT4E, 190FT5E, 190FT6E, 190FT72E, 190FT7E, 191BR1E, 191BR1G, 191BR1GA, 191BR2E, 191BR2EA, 191BR2G, 191BR2GA...(Otros modelos se puede ver en la tienda web)		



1

código	112639	referencia	3015900 3015901
descripción	pomo termostato T máx 300°C 100-300°C ø 72mm eje ø 6x4,6mm parte plana arriba rojo		
Para modelos:	08WFA4E, 08WFAAE, 10WTPGE, 12WFA6E, 12WFAAE, 191FAAE, 191FAE, 191PE4E		



1

código	110140	referencia	36M2390 36M5140
descripción	pomo interruptor marca cero ø 67mm eje ø 10x9mm parte plana arriba negro		
Para modelos:	030FT, 030FTR, 031FT, 031FTR, 031FTRL, 031TP, 070D, 070DGG, 070FT, 070FTR, 0712D, 0712VA, 071D, 071DGG, 071FT, 071FTR, 071FTRL, 071TP, 072D, 072DGG, 090, 090FT, 090FTR, 090GG, 091, 091FT, 091FTR, 091FTRL, 091GG, 091TP, 092, 092GG, 092VA, 092VAGG, 30CPS, 31, 31PD6, 31PI6, 31TC, 31TP, 32, 32TC, 32TP, 32TPV, 32V, 70CP, 712D, 712VA, 71CP, 71CP2...(Otros modelos se puede ver en la tienda web)		



1

código	110142	referencia	36M2400
descripción	pomo interruptor marca cero ø 67mm eje ø 6x4,6mm parte plana arriba negro		
Para modelos:	030BME, 030E, 030EBM, 030FE, 030FE1, 030FTE, 030FTER, 031BME, 031E, 031EBM, 031FTE, 031FTE04, 031FTE06, 031FTER, 031FTERL, 070BME, 070E, 070FTE, 070FTE04, 070FTE05, 070FTER, 071BME, 071E, 071FTE, 071FTE04, 071FTE06, 071FTER, 071FTERL, 30CPSE, 30F1, 30FES, 30FES2, 30FS2, 31GE, 31PIE6, 31TCE, 32TCE, 60SME, 70CPE, 70F1, 70FE, 70FE1, 70FES, 70FES2, 71E, 71F2, 71FE, 71FE2, 71PIE15, 71PIE15A		



1

código	110141	referencia	36M3050
descripción	pomo interruptor marca cero ø 67mm eje ø 8x6,5mm parte plana arriba negro		
Para modelos:	030, 031, 032, 31, 31GE, 31TC, 32, 32TC, 32TP, 32TPV, 32V, 60SM		



1

código	111745	referencia	36M4970
descripción	pomo interruptor marca cero ø 45mm eje ø 6x4,6mm parte plana arriba azul/negro		
Para modelos:	FCV3EM, FCV4EM		



1

código	112910	referencia	36M5270
descripción	pomo interruptor marca cero ø 45mm eje ø 6x4,6mm parte plana arriba plata		



1

código	110925	referencia	36M4560
descripción	pomo interruptor marca cero ø 45mm eje ø 6x4,6mm parte plana arriba rojo		
Para modelos:	030FE1B, 091FE28B, 30F1B, 30FES2B, 30FS2B, 70F1B, 70FE1B, 70FES2, 70FES2B, 71F2B, 71FE2B, 90F110B, 91AR, 91ARE, 91F210B, 91F223B, 91RA, FC101, FC101E, FC241, FC241E, FC241G, FC61, FC61E, FCV101, FCV101-CSA, FCV101E, FCV101E-UL, FCV141, FCV141-CSA, FCV141E, FCV241, FCV241E, FCV241E-UL, FCV241G, FCV241G-CSA, FCV61, FCV61-CSA, FCV61E, FCV61E-UL, FCV72E-UL		
accesorios para	110925		
	código	550965	referencia 3170290
	muelle de pomo ø 6x4,6mm UE 1 pzs		



1

código	110143	referencia	36M0560
descripción	pomo grifo de gas con llama piloto ø 65mm eje ø 10x8mm parte plana abajo negro		



1

código	110293	referencia	36M2580
descripción	pomo regulador de gas T máx°C°C ø 44mm eje ø Minisitmm negro		
Para modelos:	031FT04, 031FT06, 070BM, 070FT04, 070FT05, 071BM, 071FT04, 071FT06, 090BM, 090FT04, 090FT05, 091BM, 091FT04, 091FT06, 1G1BR1G, 30F, 30FS, 31R, 70F, 712D, 712VA, 71D, 71DGG, 71F, 71TP, 72D, 72DGG, 72TP, 72TPGG, 72VA, 72VAGG, 72VAS, 72VASGG, 73D, 73DGG, 73VA, 73VAD, 73VADGG, 73VAGG, FS30		



1

código	110294	referencia	36M2620
descripción	pomo T máx°C°C ø 44mm eje ø 8x5,5mm parte plana universal negro		
Para modelos:	31RE, 71AR, 71ARE, 71E, 71GE, 71GEGG, 71RA, A12A1E, A12B1E, A12B2E, A12M1E, A12Z1E, A12Z2E, A14A1E, A14B1E, A14B2E, A14M1E, A14Z1E, A14Z2E, A16A1E, A16B1E, A16B2E, A16M1E, A16Z1E, A16Z2E, A18A1E, A18B1E, A18B2E, A18M1E, A18Z1E, A18Z2E, A20A1E, A20B1E, A20B2E, A20M1E, A20Z1E, A20Z2E, ACBM, ACBM218, ACPN, ACPN218, AJ12AE, AJ12ME, AJ14AE, AJ14ME, AJ16AE, AJ16ME, AJ18AE, AJ18ME, AJ20AE...(Otros modelos se puede ver en la tienda web)		



1

código	110292	referencia	36M2800
descripción	tapa interruptor marca cero T máx°C°C ø 32mm eje ømm parte plana rojo pomo		
Para modelos:	031FT04, 031FT06, 070BM, 070FT04, 070FT05, 071BM, 071FT04, 071FT06, 090BM, 090FT04, 090FT05, 091BM, 091FT04, 091FT06, 30F, 30FS, 31R, 31RE, 70F, 712D, 712VA, 71AR, 71ARE, 71D, 71DGG, 71E, 71F, 71GE, 71GEGG, 71RA, 71TP, 72D, 72DGG, 72TP, 72TPGG, 72VA, 72VAGG, 72VAS, 72VASGG, 73D, 73DGG, 73VA, 73VAD, 73VADGG, 73VAGG, A12A1E, A12B1E, A12B2E, A12M1E, A12Z1E...(Otros modelos se puede ver en la tienda web)		



1

código	111213	referencia	36M1590 alt
descripción	pomo interruptor marca cero ø 38mm eje ø 6x4,6mm parte plana abajo negro		



1

código	111215	referencia	36M1511
descripción	pomo interruptor marca cero ø 38mm eje ø 6x4,6mm parte plana arriba negro		
Para modelos:	F60P, F60PR, F60T, F80P, F80PR, L100, L40, L40S, L45, L60, L80, SM-1LAM, SM1LM		



1

código	111212	referencia	36M1800
descripción	pomo interruptor marca cero ø 40mm eje ø 6x4,6mm parte plana arriba negro		



1

código	111218	referencia	36M4620
descripción	pomo interruptor marca cero ø 44mm eje ø 6x4,6mm parte plana arriba negro		
Para modelos:	K16APGPZ, K16XPZAP, SA16AGB, SA16GB, SI14VB, SI21VB		



1

código	110918	referencia	36M4710	
descripción	pomo interruptor marca cero ø 45mm eje ø 6x6mm negro			
accesorios para	110918			
	código	510923	referencia	—
anillo de apriete para árbol ø 10mm int.ø 9.4mm H 6mm				



1

código	112860	referencia	3104143
descripción	pomo ø 60mm eje ø 6x9mm plata		



 <p>1</p>			
código	112570	referencia	36H0900 36H0901
descripción	pomo potenciómetro ø 62mm eje ø 6x4,6mm parte plana universal negro		
Para modelos:	FM1011E1, FM1011E1-VERS.2006, FM1011E2, FM1011E2-VERS.2006, FM1011E3, FM1011E3-VERS.2006, FM1011G1, FM1011G1-VERS.2006, FM1011G2, FM1011G2-VERS.2006, FM1011G3, FM1011G3-VERS.2006, FM1221E1, FM1221E1-VERS.2006, FM1221E2, FM1221E2-VERS.2006, FM1221E3, FM1221E3-VERS.2006, FM1221G1, FM1221G1-VERS.2006, FM1221G2, FM1221G2-VERS.2006, FM1221G3, FM1221G3-VERS.2006, FM2011E2-VERS.2006, FM2011E3-VERS.2006, FM2011G2-VERS.2006, FM2011G3-VERS.2006, FM2021E1, FM2021E2, FM2021E2-VERS.2006, FM2021E3, FM2021E3-VERS.2006, FM2021G1, FM2021G2, FM2021G2-VERS.2006, FM2021G3, FM2021G3-VERS.2006, FM423E1, FM423E2, FM611E1, FM611E1-VERS.2006, FM611E2, FM611E2-VERS.2006, FM611E3, FM611E3-VERS.2006, FM611G1, FM611G1-VERS.2006, FM611G2, FM611G2-VERS.2006...(Otros modelos se puede ver en la tienda web)		

 <p>1</p>			
código	101729	referencia	3152250
descripción	junta pomo D1 ø 70mm D2 ø 7mm espesor 1mm núm. Ref. 3152250 para ANGELO PO		
Para modelos:	04WFAAV, 06WCP1GM, 08WCP1GM, 08WFA4E, 08WFA4G, 08WFAAE, 08WFAAG, 08WFAAV, 08WFT1GV, 08WFT2GV, 08WFT3GV, 08WFT4GV, 08WFT6GV, 08WFT7GV, 08WGRGV, 090BM1G, 090FT1G, 090FT2G, 090FT4G, 090FT5G, 090FT7G, 090GRG, 091CP1G, 0A0BMG, 0A0FA1, 0A0FA4, 0A0FAA, 0A0FAS, 0A0FAVA, 0A0FT1G, 0A0FT2G, 0A0FT4G, 0A0FT5G, 0A0GRG, 0A1CP1G, 0B0FAS, 0B0FT1G, 0B0FT2G, 0B0FT4G, 0B0FT5G, 0B1CP1G, 0D0BMG, 0D0FA1, 0D0FA4, 0D0FAA, 0D0FAS, 0D0FAVA, 0D0FT1G, 0D0FT2G, 0D0FT4G...(Otros modelos se puede ver en la tienda web)		

manillas y volantes

volantes

 <p>1</p>							
código	514026	referencia	36M4910				
descripción	volante ø 160mm D1 ø 40mm taladro ø 16mm rosca M8 dist. del agujero 9mm ancho de ranuramm L1 22mm L2 50mm longitud de asidero 75mm con asidero abatible						
Para modelos:	1G1BR1E, 1G1BR1G, 31R, 31RE						
accesorios para	514026						
	 <table border="1"> <tr> <td>código</td> <td>560224</td> <td>referencia</td> <td>31W0020</td> </tr> </table>	código	560224	referencia	31W0020	tornillo prisionero rosca M8 L 10mm EC 4 UE 1 pzs	
código	560224	referencia	31W0020				

accesorios

resortes para pomos

 <p>1</p>			
código	550965	referencia	3170290
descripción	muelle de pomo ø 6x4,6mm UE 1 pzs		
Para modelos:	030BME, 030E, 030EBM, 030FE, 030FE1, 030FE1B, 030FTE, 030FTE, 031BME, 031E, 031EBM, 031FTE, 031FTE04, 031FTE06, 031FTE, 031FTE04, 070BME, 070E, 070FTE, 070FTE04, 070FTE05, 070FTE, 071BME, 071E, 071FTE, 071FTE04, 071FTE06, 071FTE, 071FTE04, 090BME, 090E, 090FTE, 090FTE04, 090FTE05, 090FTE, 090SPE, 091BME, 091E, 091FE28, 091FE28B, 091FR1ED, 091FR3ED, 091FTE, 091FTE04, 091FTE06, 091FTE, 091FTE04, 0A0BME, 0A0FT1E, 0A0FT2E...(Otros modelos se puede ver en la tienda web)		

 <p>1</p>			
código	694634	referencia	3214440 3342840
descripción	volante ø 200mm D1 ø 48mm taladro ø 16mm profundidad de taladro 34mm rosca ancho de ranuramm L1 29mm L2 55mm longitud de asidero 80mm con asidero abatible plástico		
Para modelos:	191BR1E, 191BR1G, 191BR2E, 191BR2G, 1A1BR1E, 1A1BR1G, 1A1BR2E, 1A1BR2G, 1D1BR1E, 1D1BR1G, 1D1BR2E, 1D1BR2G, 291BR1E, 291BR1G, 291BR2E, 291BR2G, 2A1BR1E, 2A1BR1G, 2A1BR2E, 2A1BR2G, 2D1BR1E, 2D1BR1G, 2D1BR2E, 2D1BR2G		

juntas

 <p>1</p>			
código	550493	referencia	3150790
descripción	junta para pomo		
Para modelos:	030E, 030EBM, 030FE1, 030FE1B, 030FTE, 030FTE, 031E, 031EBM, 031FTE04, 031FTE06, 04WCP1EM, 06WFR3GD, 070E, 070FTE04, 070FTE05, 071E, 071FTE04, 071FTE06, 08WCP1GM, 08WFAAE, 090, 090BM, 090BME, 090E, 090FT, 090FTE04, 090FTE05, 090FTR, 090GG, 091, 091BM, 091BME, 091CP1E, 091CP1G, 091E, 091FE28, 091FE28B, 091FR1E, 091FR1ED, 091FR1GD, 091FR3G, 091FR3GD, 091FT, 091FTE04, 091FTE06, 091FTR, 091FTRL, 091GG, 091TP, 092...(Otros modelos se puede ver en la tienda web)		



1

código	690249	referencia	36M5560 36M5561 36M5562
descripción	volante ø 200mm D1 ø 48mm taladro ø 20mm agujero ø 7mm rosca dist. del agujero 11mm ancho de ranuramm L1 30mm L2 60mm longitud de asidero 82mm con asidero abatible		
Para modelos:	191BR1E, 191BR1G, 191BR2E, 191BR2G, 1A1BR1E, 1A1BR1G, 1A1BR2E, 1A1BR2G, 1D1BR1E, 1D1BR1G, 1D1BR2E, 1D1BR2G, 291BR1E, 291BR1G, 291BR2E, 291BR2G, 2A1BR1E, 2A1BR1G, 2A1BR2E, 2A1BR2G, 2D1BR1E, 2D1BR1G, 2D1BR2E, 2D1BR2G		
repuestos para	690249		
	código	referencia	—
	mango abatible ø 26mm longitud total 85mm soporte ø 20mm árbol ømm rosca M6 con pasador L 85mm		

manillas cilíndricas

fijo



1

código	514065	referencia	36M5750
descripción	manilla cilíndrica rosca M12 ø 23mm L 65mm		
Para modelos:	091FR1E, 091FR1EA, 091FR1ED, 0A1FR1E, 0A1FR1ED, 0D1FR1E, 0D1FR1ED, 191FR2E, 191FR2ED, 1A1FR2E, 1A1FR2ED, 1D1FR2ED		

manillas cónicas



1

código	694633	referencia	3000900
descripción	manilla cónica rosca M8x1,25 ø 28mm plástico L 105mm negro rosca L 25mm		
Para modelos:	08WGRGV, 090GRG, 0A0GRG, 0D0GRG, 190GRG, 191PD1G, 191PD2G, 191PI1G, 191PI1GA, 191PI2E, 191PI2EA, 191PI2G, 191PI2GA, 191PI2V, 191PI2VA, 1A0GRG, 1D0GRG, 1G0GRG		

barras de asidero

barras de asidero



1

código	691148	referencia	36M4830
descripción	barra de asidero H 40mm L 450mm		



1

código	691149	referencia	36M2441
descripción	barra de asidero H 40mm L 615mm		
Para modelos:	712D, 712VA, 71D, 71DGG, 71E, 71GE, 71GEGG, 71TP, 72D, 72DGG, 72TP, 72TPGG, 72VA, 72VAGG, 72VAS, 72VASGG, 73D, 73DGG, 73VA, 73VAD, 73VADGG, 73VAGG, FS30, FS30E		

consolas



1

código	691135	referencia	36M2910
descripción	consola para tirador de puerta		
Para modelos:	091T, 60SM, 60SME, 70CP, 70CPE, 70F, 70F1, 70F1B, 70FE, 70FE1, 70FE1B, 70FES, 70FES2, 70FES2B, 712D, 712VA, 71CP, 71CP2, 71D, 71DGG, 71E, 71F, 71F2, 71F2B, 71FE, 71FE2, 71FE2B, 71GE, 71GEGG, 71TP, 72D, 72DGG, 72TP, 72TPGG, 72VA, 72VAGG, 72VAS, 72VASGG, 73D, 73DGG, 73VA, 73VAD, 73VADGG, 73VAGG, 90CP, 90CPE, 91CP, 91F223B, FS30, FS30E		



1

código	690297	referencia	36D0230
descripción	consola UE 1 pzs		



agarraderos

ANGELO PO



1

código	691153	referencia	36M3590
descripción	asidero dist. del agujero 650mm		
Para modelos:	31, 31GE, 31TC, 31TCE, 31TP, 32, 32TC, 32TCE, 32TP, 32TPV, 32V		

agarraderos



1

código	691153	referencia	36M3590
descripción	asidero dist. del agujero 650mm		
Para modelos:	31, 31GE, 31TC, 31TCE, 31TP, 32, 32TC, 32TCE, 32TP, 32TPV, 32V		

asas de arco



1

código	692176	referencia	3010570 3010571 3010572 3010573
descripción	asa de arco L 295mm H 40mm distancia de sujeción 255mm rosca M5 cromado		
Para modelos:	04WBMEV, 04WCP1EM, 04WFAAV, 04WFR3ED, 04WPE4V, 04WPEBV, 04WVT1IV, 04WVT1IV-VERS.022010, 04WVT2IV, 04WVT2IV-VERS.022010, 04WVT3RV, 06WBR3E, 06WCP1GM, 06WFR3GD, 06WFT1EV, 06WFT2EV, 06WFT3EV, 06WFT4EV, 06WFT6EV, 06WFT7EV, 08WCP1GM, 08WFAAV, 08WFR4ED, 08WFT1EV, 08WFT1GV, 08WFT2EV, 08WFT2GV, 08WFT3EV, 08WFT3GV, 08WFT4EV, 08WFT4GV, 08WFT6EV, 08WFT6GV, 08WFT7EV, 08WFT7GV, 08WGRGV, 08WPE4V, 08WPEBV, 08WTPEV, 08WVT1IV, 08WVT1IV-VERS.112009, 08WVT2IV, 08WVT2IV-VERS.112009, 091CP1E, 091CP1G, 091FR1E, 091FR1EA, 091FR1ED, 091FR1EX, 091FR1G...(Otros modelos se puede ver en la tienda web)		



1

código	690451	referencia	36M4040
descripción	asa de arco L 426mm H 40mm distancia de sujeción 376mm negro		
Para modelos:	40EVP, 40PV, 40XPV, 55PV		

cubiertas



1

código	691158	referencia	3002970
descripción	cubierta para asidero plástico		
Para modelos:	PG22C, PG23CW		

sujeciones

tornillos de retención



1

código	514387	referencia	36M0840
descripción	tornillo de cierre		
accesorios para	514387		
	código	514386	referencia 36M0830
	estribo de cierre para marmita		

otros



1

código	110146	referencia	36M1100
descripción	manilla L 195mm An 65mm		



1

código	691193	referencia	36M4640
descripción	manilla rosca M5		
Para modelos:	BRPRV, BRVRV, SE14PRV, SE14VRV, SI14PRV, SI14VRV, SL14RPRV, SL14RVRV, TPRV, TVRV		



accesorios

otros



1

código	691134	referencia	36M3720
descripción	pieza distanciadora para tirador de puerta		
Para modelos:	30CPS, 30CPSE, 30F1, 30F1B, 30FES2, 30FES2B, 30FS2, 30FS2B, 31, 31GE, 31TC, 31TCE, 31TP, 32, 32TC, 32TCE, 32TP, 32TPV, 32V		

cierres

dispositivos de cierre

específico del fabricante

ANGELO PO



1

código	690662	referencia	36M0140 36M5020
descripción	cilindro de cerradura con cerrojo \varnothing 23mm rosca M19x1 anchura de pestillo 11mm medida de montaje 16,5x19mm elevación 20-28mm rosca L 15mm		
Para modelos:	135, 135-4, 135A, 135B, 135BA, 135BN, 135BNX, 135BX, 135BXE, 135BXR, 135CPX, 135NN, 135NNX, 135PVX, 135X, 135X-3, 135X-4, 135XE, 135XR, 40B, 40CP, 40CPX, 40EV, 40EVP, 65, 65A, 65B, 65BA, 65BX, 65BX-2, 65BXE, 65BXR, 65NB, 65NBX, 65NN, 65NNX, 65PVX, 65X, 65X-2, 65XE, 65XR, S125, S125-4, S125B, S125B-4, S125BE, S125BX, S125BX-4, S125E, S125X...(Otros modelos se puede ver en la tienda web)		



1

código	690462	referencia	36M7070	
descripción	cilindro de cerradura \varnothing 23mm rosca M19x1 medida de montaje 16,5x19mm elevación 38-45mm árbol \varnothing 11mm rosca L 12mm			
Para modelos:	AF1B, AF1B-OPR01, AF1N, AF1N-OPR01, AF2B, AF2B-OPR01, AF2N, AF2N-OPR01, AGL6B, CX120, CX120B, CX120NN, CX130, CX130B, CX130NN, CX140, CX140B, CX140BN, CX140BR, CX140CP, CX140NN, CX140R, CX150, CX150B, CX150BN, CX150BR, CX150CP, CX150NN, CX150R, CX55, CX55B, CX60, CX60B, CX65, CX652, CX65B, CX65BR, CX65NB, CX65NCP, CX65NN, CX65R, CX70, CX702, CX70B, CX70BR, CX70NB, CX70NN, CX70R, FG2B, FSD1B...(Otros modelos se puede ver en la tienda web)			
repuestos para	690462			
	código	691589	referencia	—
	llave de reserva para cilindro de cerradura 690462 número de llave 9233			

cierres de palanca pivotante

universal

RAHRBACH



1

código	690500	referencia	36M0880 36M3180 36M6380 6300421	
descripción	cierre de palanca derecho L 185mm H 66mm material de asidero plástico tipo serie 6300			
Para modelos:	FC101, FC101E, FC241, FC241E, FC241G, FC61, FC61E, FCV101, FCV101-CSA, FCV101DM, FCV101DM-CSA, FCV101DS, FCV101DS-CSA, FCV101E, FCV101EDM, FCV101EDM-UL, FCV101EDS, FCV101EDS-UL, FCV101E-UL, FCV141, FCV141-CSA, FCV141DM, FCV141DM-CSA, FCV141DS, FCV141DS-CSA, FCV141E, FCV141EDM, FCV141EDS, FCV241, FCV241DM, FCV241DS, FCV241E, FCV241EDM, FCV241EDM-UL, FCV241EDS, FCV241EDS-UL, FCV241E-UL, FCV241G, FCV241G-CSA, FCV241GDM, FCV241GDM-CSA, FCV241GDS, FCV241GDS-CSA, FCV401DM, FCV401DM-CSA, FCV401EDM, FCV401EDM-UL, FCV61, FCV61-CSA, FCV61DM...(Otros modelos se puede ver en la tienda web)			
repuestos para	690500			
	código	699841	referencia	—
	tapa para cierre de palanca picotante \varnothing 32mm H 14mm			
accesorios para	690500			
	código	514281	referencia	36M1570
	placa de asiento L 110mm An 35mm para retén espesor 10mm			
	código	690136	referencia	3FL0197
	placa de fricción pos. de montaje derecho L 28mm H 3mm An 21mm H2 12.5mm			
	código	691174	referencia	35V9050
	contrapieza L 90mm An 60mm para cierre de puerta			
	código	700091	referencia	—
	retén pos. de montaje derecho sobresaliente 20mm L 110mm H 56mm An 33mm distancia de sujeción 68/68mm cinc presofundido serie 6300			
	código	700098	referencia	36M0820
	retén pos. de montaje derecho sobresaliente 38mm L 110mm H 74mm An 33mm distancia de sujeción 68/68mm serie 1750			



1

código	690136	referencia	3FL0197
descripción	placa de fricción pos. de montaje derecho L 28mm H 3mm An 21mm H2 12.5mm		
Para modelos:	FCV101-CSA, FCV101DM-CSA, FCV101DS-CSA, FCV101EDM-UL, FCV101EDS-UL, FCV101E-UL, FCV141-CSA, FCV141DM-CSA, FCV141DS-CSA, FCV241EDM-UL, FCV241EDS-UL, FCV241E-UL, FCV241G-CSA, FCV241GDM-CSA, FCV241GDS-CSA, FCV401DM-CSA, FCV401EDM-UL, FCV61-CSA, FCV61DM-CSA, FCV61DS-CSA, FCV61EDM-UL, FCV61EDS-UL, FCV61E-UL, FCV72EDM-UL, FCV72EDS-UL, FCV72E-UL		











			
código	690137	referencia	36E2530 6300843
descripción	placa de fricción pos. de montaje izquierdo L 28mm H 3mm An 21mm H2 12.5mm		
Para modelos:	FC101, FC1011E, FC1011G, FC101E, FC1221E, FC1221G, FC241, FC241E, FC241G, FC61, FC611E, FC611G, FC61E, FCV101, FCV101DM, FCV101DS, FCV101E, FCV101EDM, FCV101EDS, FCV141, FCV141DM, FCV141DS, FCV141E, FCV141EDM, FCV141EDS, FCV241, FCV241DM, FCV241DS, FCV241E, FCV241EDM, FCV241EDS, FCV241G, FCV241GDM, FCV241GDS, FCV401DM, FCV401EDM, FCV61, FCV61DM, FCV61DS, FCV61E, FCV61EDM, FCV61EDS, FM1011E1, FM1011E1-VERS.2006, FM1011E2, FM1011E2-VERS.2006, FM1011E3, FM1011E3-VERS.2006, FM1011G1, FM1011G1-VERS.2006...(Otros modelos se puede ver en la tienda web)		

			
código	700098	referencia	36M0820
descripción	retén pos. de montaje derecho sobresaliente 38mm L 110mm H 74mm An 33mm distancia de sujeción 68/68mm serie 1750		
Para modelos:	FC101, FC101E, FC241, FC241E, FC241G, FC61, FC61E, FCV101, FCV101-CSA, FCV101DM, FCV101DM-CSA, FCV101DS, FCV101DS-CSA, FCV101E, FCV101EDM, FCV101EDM-UL, FCV101EDS, FCV101EDS-UL, FCV101E-UL, FCV141, FCV141-CSA, FCV141DM, FCV141DM-CSA, FCV141DS, FCV141DS-CSA, FCV141E, FCV141EDM, FCV141EDS, FCV241, FCV241DM, FCV241DS, FCV241E, FCV241EDM, FCV241EDM-UL, FCV241EDS, FCV241EDS-UL, FCV241E-UL, FCV241G, FCV241G-CSA, FCV241GDM, FCV241GDM-CSA, FCV241GDS, FCV241GDS-CSA, FCV401DM, FCV401DM-CSA, FCV401EDM, FCV401EDM-UL, FCV61, FCV61-CSA, FCV61DM...(Otros modelos se puede ver en la tienda web)		
repuestos para	700098		
	código	referencia	690136 3FL0197
	 placa de fricción pos. de montaje derecho L 28mm H 3mm An 21mm H2 12.5mm		
accesorios para	700098		
	código	referencia	514281 36M1570
	 placa de asiento L 110mm An 35mm para retén espesor 10mm		

STUV			
			
código	700098	referencia	36M0820
descripción	retén pos. de montaje derecho sobresaliente 38mm L 110mm H 74mm An 33mm distancia de sujeción 68/68mm serie 1750		
Para modelos:	FC101, FC101E, FC241, FC241E, FC241G, FC61, FC61E, FCV101, FCV101-CSA, FCV101DM, FCV101DM-CSA, FCV101DS, FCV101DS-CSA, FCV101E, FCV101EDM, FCV101EDM-UL, FCV101EDS, FCV101EDS-UL, FCV101E-UL, FCV141, FCV141-CSA, FCV141DM, FCV141DM-CSA, FCV141DS, FCV141DS-CSA, FCV141E, FCV141EDM, FCV141EDS, FCV241, FCV241DM, FCV241DS, FCV241E, FCV241EDM, FCV241EDM-UL, FCV241EDS, FCV241EDS-UL, FCV241E-UL, FCV241G, FCV241G-CSA, FCV241GDM, FCV241GDM-CSA, FCV241GDS, FCV241GDS-CSA, FCV401DM, FCV401DM-CSA, FCV401EDM, FCV401EDM-UL, FCV61, FCV61-CSA, FCV61DM...(Otros modelos se puede ver en la tienda web)		
repuestos para	700098		
	código	referencia	690136 3FL0197
	 placa de fricción pos. de montaje derecho L 28mm H 3mm An 21mm H2 12.5mm		
accesorios para	700098		
	código	referencia	514281 36M1570
	 placa de asiento L 110mm An 35mm para retén espesor 10mm		

específico del fabricante			
ANGELO PO			
			
código	694227	referencia	36E2570
descripción	cierre de palanca vaporizador combinado		
Para modelos:	FC1011E, FC1011G, FC1221E, FC1221G, FC611E, FC611G, FM1011E1, FM1011E1-VERS.2006, FM1011E2, FM1011E2-VERS.2006, FM1011E3, FM1011E3-VERS.2006, FM1011G1, FM1011G1-VERS.2006, FM1011G2, FM1011G2-VERS.2006, FM1011G3, FM1011G3-VERS.2006, FM1221E1, FM1221E1-VERS.2006, FM1221E2, FM1221E2-VERS.2006, FM1221E3, FM1221E3-VERS.2006, FM1221G1, FM1221G1-VERS.2006, FM1221G2, FM1221G2-VERS.2006, FM1221G3, FM1221G3-VERS.2006, FM2011E2-VERS.2006, FM2011E3-VERS.2006, FM2011G2-VERS.2006, FM2011G3-VERS.2006, FM2021E1, FM2021E2, FM2021E2-VERS.2006, FM2021E3, FM2021E3-VERS.2006, FM2021G1, FM2021G2, FM2021G2-VERS.2006, FM2021G3, FM2021G3-VERS.2006, FM611E1, FM611E1-VERS.2006, FM611E2, FM611E2-VERS.2006, FM611E3, FM611E3-VERS.2006...(Otros modelos se puede ver en la tienda web)		
accesorios para	694227		
	código	referencia	694640 36E2580 36E2581
	 retén H 42mm pos. de montaje izquierdo L 98mm An 42mm para cierre de palanca picotante		

			
código	694640	referencia	36E2580 36E2581
descripción	retén H 42mm pos. de montaje izquierdo L 98mm An 42mm para cierre de palanca picotante		
Para modelos:	FC1011E, FC1011G, FC1221E, FC1221G, FC611E, FC611G, FM1011E1, FM1011E1-VERS.2006, FM1011E2, FM1011E2-VERS.2006, FM1011E3, FM1011E3-VERS.2006, FM1011G1, FM1011G1-VERS.2006, FM1011G2, FM1011G2-VERS.2006, FM1011G3, FM1011G3-VERS.2006, FM1221E1, FM1221E1-VERS.2006, FM1221E2, FM1221E2-VERS.2006, FM1221E3, FM1221E3-VERS.2006, FM1221G1, FM1221G1-VERS.2006, FM1221G2, FM1221G2-VERS.2006, FM1221G3, FM1221G3-VERS.2006, FM2011E2-VERS.2006, FM2011E3-VERS.2006, FM2011G2-VERS.2006, FM2011G3-VERS.2006, FM2021E1, FM2021E2, FM2021E2-VERS.2006, FM2021E3, FM2021E3-VERS.2006, FM2021G1, FM2021G2, FM2021G2-VERS.2006, FM2021G3, FM2021G3-VERS.2006, FM611E1, FM611E1-VERS.2006, FM611E2, FM611E2-VERS.2006, FM611E3, FM611E3-VERS.2006...(Otros modelos se puede ver en la tienda web)		
accesorios para	694640		
	código	referencia	694227 36E2570
	 cierre de palanca vaporizador combinado		



			
1			
código	690500	referencia	36M0880 36M3180 36M6380 6300421
descripción	cierre de palanca derecho L 185mm H 66mm material de asidero plástico tipo serie 6300		
Para modelos:	FC101, FC101E, FC241, FC241E, FC241G, FC61, FC61E, FCV101, FCV101-CSA, FCV101DM, FCV101DM-CSA, FCV101DS, FCV101DS-CSA, FCV101E, FCV101EDM, FCV101EDM-UL, FCV101EDS, FCV101EDS-UL, FCV101E-UL, FCV141, FCV141-CSA, FCV141DM, FCV141DM-CSA, FCV141DS, FCV141DS-CSA, FCV141E, FCV141EDM, FCV141EDS, FCV241, FCV241DM, FCV241DS, FCV241E, FCV241EDM, FCV241EDM-UL, FCV241EDS, FCV241EDS-UL, FCV241E-UL, FCV241G, FCV241G-CSA, FCV241GDM, FCV241GDM-CSA, FCV241GDS, FCV241GDS-CSA, FCV401DM, FCV401DM-CSA, FCV401EDM, FCV401EDM-UL, FCV61, FCV61-CSA, FCV61DM... (Otros modelos se puede ver en la tienda web)		
repuestos para	690500		
	código	699841	referencia —
tapa para cierre de palanca picotante ø 32mm H 14mm			
accesorios para	690500		
	código	514281	referencia 36M1570
placa de asiento L 110mm An 35mm para retén espesor 10mm			
	código	690136	referencia 3FL0197
placa de fricción pos. de montaje derecho L 28mm H 3mm An 21mm H2 12.5mm			
	código	691174	referencia 35V9050
contrapieza L 90mm An 60mm para cierre de puerta			
	código	700091	referencia —
retén pos. de montaje derecho sobresaliente 20mm L 110mm H 56mm An 33mm distancia de sujeción 68/68mm cinc presofundido serie 6300			
	código	700098	referencia 36M0820
retén pos. de montaje derecho sobresaliente 38mm L 110mm H 74mm An 33mm distancia de sujeción 68/68mm serie 1750			

			
1			
código	691174	referencia	35V9050
descripción	contrapieza L 90mm An 60mm para cierre de puerta		
Para modelos:	FC101, FC101E, FC241E, FC241G, FC61, FC61E, FCV101, FCV101-CSA, FCV101DM, FCV101DM-CSA, FCV101DS, FCV101DS-CSA, FCV101E, FCV101EDM, FCV101EDM-UL, FCV101EDS, FCV101EDS-UL, FCV101E-UL, FCV141, FCV141-CSA, FCV141DM, FCV141DM-CSA, FCV141DS, FCV141DM-CSA, FCV141E, FCV141EDM, FCV141EDS, FCV241, FCV241DM, FCV241DS, FCV241E, FCV241EDM, FCV241EDM-UL, FCV241EDS, FCV241EDS-UL, FCV241E-UL, FCV241G, FCV241G-CSA, FCV241GDM, FCV241GDM-CSA, FCV241GDS, FCV241GDS-CSA, FCV401DM, FCV401DM-CSA, FCV401EDM, FCV401EDM-UL, FCV61, FCV61-CSA, FCV61DM, FCV61DM-CSA, FCV61DS, FCV61DS-CSA, FCV61E, FCV61EDM, FCV61EDM-UL, FCV61EDS, FCV61EDS-UL, FCV61E-UL... (Otros modelos se puede ver en la tienda web)		

			
1			
código	514281	referencia	36M1570
descripción	placa de asiento L 110mm An 35mm para retén espesor 10mm		
Para modelos:	FC101, FC101E, FC241, FC241E, FC241G, FC61, FC61E, FCV101, FCV101-CSA, FCV101DM, FCV101DM-CSA, FCV101DS, FCV101DS-CSA, FCV101E, FCV101EDM, FCV101EDM-UL, FCV101EDS, FCV101EDS-UL, FCV101E-UL, FCV141, FCV141-CSA, FCV141DM, FCV141DM-CSA, FCV141DS, FCV141DS-CSA, FCV141E, FCV141EDM, FCV141EDS, FCV241, FCV241DM, FCV241DS, FCV241E, FCV241EDM, FCV241EDM-UL, FCV241EDS, FCV241EDS-UL, FCV241E-UL, FCV241G, FCV241G-CSA, FCV241GDM, FCV241GDM-CSA, FCV241GDS, FCV241GDS-CSA, FCV61, FCV61-CSA, FCV61DM, FCV61DM-CSA, FCV61DS, FCV61DS-CSA, FCV61E... (Otros modelos se puede ver en la tienda web)		

			
1			
código	690136	referencia	3FL0197
descripción	placa de fricción pos. de montaje derecho L 28mm H 3mm An 21mm H2 12.5mm		
Para modelos:	FCV101-CSA, FCV101DM-CSA, FCV101DS-CSA, FCV101EDM-UL, FCV101EDS-UL, FCV101E-UL, FCV141-CSA, FCV141DM-CSA, FCV141DS-CSA, FCV241EDM-UL, FCV241EDS-UL, FCV241E-UL, FCV241G-CSA, FCV241GDM-CSA, FCV241GDS-CSA, FCV401DM-CSA, FCV401EDM-UL, FCV61-CSA, FCV61DM-CSA, FCV61DS-CSA, FCV61EDM-UL, FCV61EDS-UL, FCV61E-UL, FCV72EDM-UL, FCV72EDS-UL, FCV72E-UL		

			
1			
código	700711	referencia	6300420
descripción	retén		
Para modelos:	FC101, FC101E, FC241, FC241E, FC241G, FC61, FC61E, FCV101, FCV101-CSA, FCV101DM, FCV101DM-CSA, FCV101DS, FCV101DS-CSA, FCV101E, FCV101EDM, FCV101EDM-UL, FCV101EDS, FCV101EDS-UL, FCV101E-UL, FCV141, FCV141-CSA, FCV141DM, FCV141DM-CSA, FCV141DS, FCV141DS-CSA, FCV141E, FCV141EDM, FCV141EDS, FCV241, FCV241DM, FCV241DS, FCV241E, FCV241EDM, FCV241EDM-UL, FCV241EDS, FCV241EDS-UL, FCV241E-UL, FCV241G, FCV241G-CSA, FCV241GDM, FCV241GDM-CSA, FCV241GDS, FCV241GDS-CSA, FCV401DM, FCV401DM-CSA, FCV401EDM, FCV401EDM-UL, FCV61, FCV61-CSA, FCV61DM... (Otros modelos se puede ver en la tienda web)		
accesorios para	700711		
	código	514281	referencia 36M1570
placa de asiento L 110mm An 35mm para retén espesor 10mm			
	código	700098	referencia 36M0820
retén pos. de montaje derecho sobresaliente 38mm L 110mm H 74mm An 33mm distancia de sujeción 68/68mm serie 1750			

			
1			
código	700098	referencia	36M0820
descripción	retén pos. de montaje derecho sobresaliente 38mm L 110mm H 74mm An 33mm distancia de sujeción 68/68mm serie 1750		
Para modelos:	FC101, FC101E, FC241, FC241E, FC241G, FC61, FC61E, FCV101, FCV101-CSA, FCV101DM, FCV101DM-CSA, FCV101DS, FCV101DS-CSA, FCV101E, FCV101EDM, FCV101EDM-UL, FCV101EDS, FCV101EDS-UL, FCV101E-UL, FCV141, FCV141-CSA, FCV141DM, FCV141DM-CSA, FCV141DS, FCV141DS-CSA, FCV141E, FCV141EDM, FCV141EDS, FCV241, FCV241DM, FCV241DS, FCV241E, FCV241EDM, FCV241EDM-UL, FCV241EDS, FCV241EDS-UL, FCV241E-UL, FCV241G, FCV241G-CSA, FCV241GDM, FCV241GDM-CSA, FCV241GDS, FCV241GDS-CSA, FCV401DM, FCV401DM-CSA, FCV401EDM, FCV401EDM-UL, FCV61, FCV61-CSA, FCV61DM...(Otros modelos se puede ver en la tienda web)		
repuestos para	700098		
	código	referencia	3FL0197
	 placa de fricción pos. de montaje derecho L 28mm H 3mm An 21mm H2 12.5mm		
accesorios para	700098		
	código	referencia	36M1570
	 placa de asiento L 110mm An 35mm para retén espesor 10mm		









			
1			
código	111786	referencia	37M4040
descripción	símbolo para pomo		
Para modelos:	FC101, FC101E, FC241, FC241E, FC241G, FC61, FC61E, FCV101, FCV101-CSA, FCV101DM, FCV101DS, FCV101E, FCV101EDM, FCV101EDS, FCV101EDS-UL, FCV101E-UL, FCV141, FCV141DM, FCV141DS, FCV141E, FCV141EDM, FCV141EDS, FCV241, FCV241DM, FCV241DS, FCV241E, FCV241EDM, FCV241EDM-UL, FCV241EDS, FCV241EDS-UL, FCV241G, FCV241G-CSA, FCV241GDM, FCV241GDS, FCV401DM, FCV401EDM, FCV4E, FCV4EDS, FCV61, FCV61DM, FCV61DS, FCV61E, FCV61EDM, FCV61EDS, FCV61E-UL, FCV72EDM-UL, FCV72EDS-UL		

cierres de palanca

universal

fijación interna

cierres

			
1			
código	694054	referencia	36M7000
descripción	manilla de puerta para aparatos calientes L 145mm An 40mm H 62mm longitud muelle 33mm interior negro		
Para modelos:	BX101E, BX101E-VERS.122013, BX101G, BX101G-VERS.122013, BX122E, BX122E-VERS.122013, BX122G, BX122G-VERS.122013, BX61E, BX61E-VERS.122013, BX61G, BX61G-VERS.122013, BX82E, BX82E-VERS.122013, BX82G, BX82G-VERS.122013, FCV3EM, FCV4E, FCV4EDS, FCV4EM, FM423E1, FM423E2		
repuestos para	694054		
	código	referencia	3005920 3236250
	 resorte para tirador de puerta ø 6mm L 54mm An 27.5mm		
	código	referencia	—
	 cierre de puerta L 88mm An 40mm H 37mm longitud muelle 33mm distancia de sujeción 60mm		
	código	referencia	—
	 manilla de puerta L 165mm An 40mm H 25mm negro		
	código	referencia	—
	 capuchón ø 32mm negro		
accesorios para	694054		
	código	referencia	36E2060
	 orificio de paso para abrepuertas		
	código	referencia	3238740 3238750 36C4391
	 retén L 25mm An 14mm longitud total 54mm rosca M8 rosca L 29mm		
	código	referencia	—
	 retén con espiga 2 niveles L 28mm An 14mm H 15mm H1 16mm longitud total 51mm rosca M8 rosca L 23mm acero inoxidable		
	código	referencia	3108770
	 retén con espiga 1 nivel L 26mm longitud total 51mm rosca M8		

específico del fabricante

ANGELO PO



1

código	514287	referencia	36Q1360
---------------	--------	-------------------	---------

descripción	casquillo H 8mm espesor 2mm D1 ø 14mm D2 ø 10mm
--------------------	---

Para modelos:	FCV3EM, FCV4E, FCV4EDS, FCV4EM
----------------------	--------------------------------



1

código	514286	referencia	36D8011
---------------	--------	-------------------	---------

descripción	casquillo L 15mm M20x1.5
--------------------	--------------------------

Para modelos:	FCV3EM, FCV4E, FCV4EDS, FCV4EM
----------------------	--------------------------------



1

código	514289	referencia	36D3670
---------------	--------	-------------------	---------

descripción	casquillo para mecánica de puertas
--------------------	------------------------------------

Para modelos:	FCV3EM, FCV4E, FCV4EDS, FCV4EM
----------------------	--------------------------------



1

código	514288	referencia	30G1650 30G2192
---------------	--------	-------------------	--------------------

descripción	cierre de puerta ø 10mm L 102mm achura de réten 24mm G1: M8 G2: M20x1.5
--------------------	---

Para modelos:	FCV3EM, FCV4E, FCV4EDS, FCV4EM
----------------------	--------------------------------

accesorios para	514288
------------------------	--------



1

código	514287	referencia	36Q1360
---------------	--------	-------------------	---------

descripción	casquillo H 8mm espesor 2mm D1 ø 14mm D2 ø 10mm
--------------------	---



1

código	514290	referencia	36M5340
---------------	--------	-------------------	---------

descripción	manilla de puerta L 150mm An 42mm H 57mm negro plástico eje 8x8mm soporte cuadrado
--------------------	--

Para modelos:	FCV3EM, FCV4E, FCV4EDS, FCV4EM
----------------------	--------------------------------

accesorios para	514290
------------------------	--------



1

código	111746	referencia	37M4700
---------------	--------	-------------------	---------

descripción	símbolo para pomo An 1mm ø 36mm
--------------------	---------------------------------



1

código	111786	referencia	37M4040
---------------	--------	-------------------	---------

descripción	símbolo para pomo
--------------------	-------------------

accesorios para	514290
------------------------	--------



1

código	514286	referencia	36D8011
---------------	--------	-------------------	---------

descripción	casquillo L 15mm M20x1.5
--------------------	--------------------------



1

código	514287	referencia	36Q1360
---------------	--------	-------------------	---------

descripción	casquillo H 8mm espesor 2mm D1 ø 14mm D2 ø 10mm
--------------------	---



1

código	514288	referencia	30G1650 30G2192
---------------	--------	-------------------	--------------------

descripción	cierre de puerta ø 10mm L 102mm achura de réten 24mm G1: M8 G2: M20x1.5
--------------------	---



1

código	514289	referencia	36D3670
---------------	--------	-------------------	---------

descripción	casquillo para mecánica de puertas
--------------------	------------------------------------



1

código	111786	referencia	37M4040
---------------	--------	-------------------	---------

descripción	símbolo para pomo
--------------------	-------------------

Para modelos:	FC101, FC101E, FC241, FC241E, FC241G, FC61, FC61E, FCV101, FCV101-CSA, FCV101DM, FCV101DS, FCV101E, FCV101EDM, FCV101EDS, FCV101EDS-UL, FCV101E-UL, FCV141, FCV141DM, FCV141DS, FCV141E, FCV141EDM, FCV141EDS, FCV241, FCV241DM, FCV241DS, FCV241E, FCV241EDM, FCV241EDM-UL, FCV241EDS, FCV241EDS-UL, FCV241G, FCV241G-CSA, FCV241GDM, FCV241GDS, FCV401DM, FCV401EDM, FCV4E, FCV4EDS, FCV61, FCV61DM, FCV61DS, FCV61E, FCV61EDM, FCV61EDS, FCV61E-UL, FCV72EDM-UL, FCV72EDS-UL
----------------------	---



1

código	111746	referencia	37M4700
---------------	--------	-------------------	---------

descripción	símbolo para pomo An 1mm ø 36mm
--------------------	---------------------------------

Para modelos:	FCV3EM, FCV4EM
----------------------	----------------



1

código	694054	referencia	36M7000
---------------	--------	-------------------	---------

descripción	manilla de puerta para aparatos calientes L 145mm An 40mm H 62mm longitud muelle 33mm interior negro
--------------------	--

Para modelos:	BX101E, BX101E-VERS.122013, BX101G, BX101G-VERS.122013, BX122E, BX122E-VERS.122013, BX122G, BX122G-VERS.122013, BX61E, BX61E-VERS.122013, BX61G, BX61G-VERS.122013, BX82E, BX82E-VERS.122013, BX82G, BX82G-VERS.122013, FCV3EM, FCV4E, FCV4EDS, FCV4EM, FM423E1, FM423E2
----------------------	--

repuestos para	694054
-----------------------	--------



1

código	514390	referencia	3005920 3236250
---------------	--------	-------------------	--------------------



descripción	resorte para tirador de puerta ø 6mm L 54mm An 27.5mm
--------------------	---

Continúa en la página siguiente

repuestos para 694054	
	código 694675 referencia —
cierre de puerta L 88mm An 40mm H 37mm longitud muelle 33mm distancia de sujeción 60mm	
	código 694734 referencia —
manilla de puerta L 165mm An 40mm H 25mm negro	
	código 694735 referencia —
capuchón ø 32mm negro	
accesorios para 694054	
	código 691123 referencia 36E2060
orificio de paso para abrepuertas	
	código 694055 referencia 3238740 3238750 36C4391
retén L 25mm An 14mm longitud total 54mm rosca M8 rosca L 29mm	
	código 694066 referencia —
retén con espiga 2 niveles L 28mm An 14mm H 15mm H1 16mm longitud total 51mm rosca M8 rosca L 23mm acero inoxidable	
	código 694067 referencia 3108770
retén con espiga 1 nivel L 26mm longitud total 51mm rosca M8	

	código 691123 referencia 36E2060
descripción orificio de paso para abrepuertas	
Para modelos: FCV3EM, FCV4E, FCV4EDS, FCV4EM, FM423E1, FM423E2	

	código 514390 referencia 3005920 3236250
descripción resorte para tirador de puerta ø 6mm L 54mm An 27.5mm	
Para modelos: BX101E, BX101E-VERS.122013, BX101G, BX101G-VERS.122013, BX122E, BX122E-VERS.122013, BX122G, BX122G-VERS.122013, BX61E, BX61E-VERS.122013, BX61G, BX61G-VERS.122013, BX82E, BX82E-VERS.122013, BX82G, BX82G-VERS.122013, FCV3EM, FCV4E, FCV4EDS, FCV4EM, FM423E1, FM423E2, FX101E1R, FX101E2R, FX101E2R-VERS.032014, FX101E3R, FX101E3R-VERS.022014, FX101G1R, FX101G2R, FX101G2R-VERS.032014, FX101G3R, FX101G3R-VERS.022014, FX10E2CR, FX10E2CR-VERS.032014, FX10E3CR, FX10E3CR-VERS.022014, FX10G2CR, FX10G2CR-VERS.032014, FX10G3CR, FX10G3CR-VERS.022014, FX61E1R, FX61E2CR, FX61E2CR-VERS.032014, FX61E2R, FX61E2R-VERS.032014, FX61E3CR, FX61E3CR-VERS.022014, FX61E3R, FX61E3R-VERS.022014, FX61G1R...(Otros modelos se puede ver en la tienda web)	

	código 694055 referencia 3238740 3238750 36C4391
descripción retén L 25mm An 14mm longitud total 54mm rosca M8 rosca L 29mm	
Para modelos: BX101E, BX101E-VERS.122013, BX101G, BX101G-VERS.122013, BX122E, BX122E-VERS.122013, BX122G, BX122G-VERS.122013, BX61E, BX61E-VERS.122013, BX61G, BX61G-VERS.122013, BX82E, BX82E-VERS.122013, BX82G, BX82G-VERS.122013, FCV3EM, FCV4E, FCV4EDS, FCV4EM, FM423E1, FM423E2, FX101E1, FX101E1R, FX101E2, FX101E2C, FX101E2C-VERS.032014, FX101E2R, FX101E2R-VERS.032014, FX101E2-VERS.032014, FX101E3, FX101E3C, FX101E3C-VERS.022014, FX101E3R, FX101E3R-VERS.022014, FX101E3-VERS.022014, FX101G1, FX101G1R, FX101G2, FX101G2C, FX101G2C-VERS.032014, FX101G2R, FX101G2R-VERS.032014, FX101G2-VERS.032014, FX101G3, FX101G3C, FX101G3C-VERS.022014, FX101G3R, FX101G3R-VERS.022014, FX101G3-VERS.022014...(Otros modelos se puede ver en la tienda web)	
accesorios para 694055	
	código 694772 referencia 36E2490
tapa de protección para retén ø 21mm	

	código 694772 referencia 36E2490
descripción tapa de protección para retén ø 21mm	
Para modelos: BX101E, BX101E-VERS.122013, BX101G, BX101G-VERS.122013, BX122E, BX122E-VERS.122013, BX122G, BX122G-VERS.122013, BX61E, BX61E-VERS.122013, BX61G, BX61G-VERS.122013, BX82E, BX82E-VERS.122013, BX82G, BX82G-VERS.122013, FCV3EM, FCV4E, FCV4EDS, FCV4EM, FM423E1, FM423E2, FX101E1, FX101E1R, FX101E2, FX101E2C, FX101E2C-VERS.032014, FX101E2R, FX101E2R-VERS.032014, FX101E2-VERS.032014, FX101E3, FX101E3C, FX101E3C-VERS.022014, FX101E3R, FX101E3R-VERS.022014, FX101E3-VERS.022014, FX101G1, FX101G1R, FX101G2, FX101G2C, FX101G2C-VERS.032014, FX101G2R, FX101G2R-VERS.032014, FX101G2-VERS.032014, FX101G3, FX101G3C, FX101G3C-VERS.022014, FX101G3R, FX101G3R-VERS.022014, FX101G3-VERS.022014...(Otros modelos se puede ver en la tienda web)	

	código 517174 referencia 3110050 33Q6470
descripción tuerca rosca M8 H 6.5mm EC 13 inox DIN/ISO DIN 934 / ISO 4032/8673 UE 1 pzs	

manillas



código	694631	referencia	3104201 3104202 3104203
descripción	manilla de puerta para horno a vapor combinado L 210mm An 170mm H 55mm plata plástico		
Para modelos:	FX101E1, FX101E2, FX101E2C, FX101E2C-VERS.032014, FX101E2-VERS.032014, FX101E3, FX101E3C, FX101E3C-VERS.022014, FX101E3R, FX101E3-VERS.022014, FX101G1, FX101G2, FX101G2C, FX101G2C-VERS.032014, FX101G2-VERS.032014, FX101G3, FX101G3C, FX101G3C-VERS.022014, FX101G3-VERS.022014, FX10E2CR-VERS.032014, FX122E1, FX122E2, FX122E2C, FX122E2T, FX122E2T-VERS.032014, FX122E3, FX122E3C, FX122E3T, FX122E3T-VERS.022014, FX122G1, FX122G3, FX122G3C, FX122G3T, FX122G3T-VERS.022014, FX12E3CT, FX12E3CT-VERS.022014, FX12G3CT, FX12G3CT-VERS.022014, FX201E2, FX201E2P, FX201E2P-VERS.032014, FX201E2-VERS.032014, FX201E3, FX201E3P, FX201E3P-VERS.022014, FX201E3-VERS.022014, FX201G2, FX201G2P, FX201G2P-VERS.032014, FX201G2-VERS.032014...(Otros modelos se puede ver en la tienda web)		

cierres angulares

cierres de palanca

CAFF/FERMOD

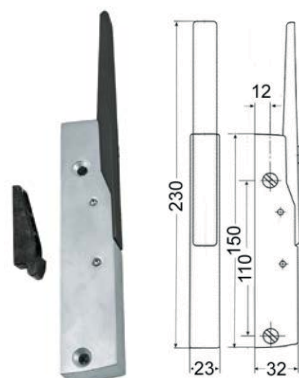

código	690454	referencia	36M0470
descripción	cierre de palanca L 150mm distancia de sujeción 110mm cromado mate/Rilsan sin cierre aparatos térmicos 560 negro completo con retén		
repuestos para	690454		
	código	690429	referencia —
	retén ER 25.5mm		
accesorios para	690454		
	código	690428	referencia 36M0480
	retén H 51mm An 13.9mm distancia de sujeción 30mm plástico ER 16.5mm		
	código	690445	referencia —
	placa de asiento H 2mm		
	código	690446	referencia —
	placa de asiento H 5mm L 56mm An 18mm		

RAHRBACH

serie 6201 DUPLO

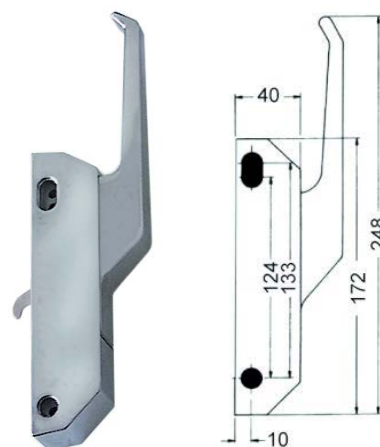

código	690024	referencia	36M0600
descripción	cierre de palanca L 172mm distancia de sujeción 124/133mm cromado sin cierre aparatos de refrigeración 6201 H 65mm tipo DUPLO longitud total 248mm		
accesorios para	690024		
	código	690123	referencia —
	retén con rueda		

retén



código	690428	referencia	36M0480
descripción	retén H 51mm An 13.9mm distancia de sujeción 30mm plástico ER 16.5mm		

cierres de enganche

universal



código	690596	referencia	36M3600
descripción	cierre de enganche L 60mm An 15mm H 36mm distancia de sujeción 48/28mm espesor de resorte 1.5mm completo con retén zamak		

cierres de pestillo espagnolette

universal



			
1			
código	690041	referencia	3088460
descripción	pestillo L 148mm distancia de sujeción 32mm		

específicas del fabricante

ANGELO PO

			
1			
código	698478	referencia	3142670
descripción	acoplamiento para horno para puerta L 80mm An 26mm soporte 7,8 x 7,8		
Para modelos:	FX201E2, FX201E2P, FX201E2P-VERS.032014, FX201E2-VERS.032014, FX201E3, FX201E3P, FX201E3P-VERS.022014, FX201E3-VERS.022014, FX201G2, FX201G2P, FX201G2P-VERS.032014, FX201G2-VERS.032014, FX201G3P, FX201G3-VERS.022014, FX202E2, FX202E2-VERS.032014, FX202E3, FX202E3-230V-3-50Hz-60Hz, FX202E3-230V-3-50Hz-60Hz-VERS.022014, FX202E3-VERS.022014, FX202G2, FX202G2-VERS.032014, FX202G3, FX202G3-VERS.022014		

			
1			
código	698503	referencia	6300965
descripción	cierre de pestillo espagnolette completo		
Para modelos:	FX201E2, FX201E2P, FX201E2P-VERS.032014, FX201E2-VERS.032014, FX201E3, FX201E3P, FX201E3P-VERS.022014, FX201E3-VERS.022014, FX201G2, FX201G2P, FX201G2P-VERS.032014, FX201G2-VERS.032014, FX201G3P, FX201G3-VERS.022014, FX202E2, FX202E2-VERS.032014, FX202E3, FX202E3-230V-3-50Hz-60Hz, FX202E3-230V-3-50Hz-60Hz-VERS.022014, FX202E3-VERS.022014, FX202G2, FX202G2-VERS.032014, FX202G3, FX202G3-VERS.022014		

accesorios para	698503		
	código	690041	referencia 3088460
	pestillo L 148mm distancia de sujeción 32mm		
	código	694409	referencia —
	kit de montaje para cierre de pestillo espagnolette 694382		
	código	700604	referencia —
	mecanismo de cierre apertura a derechas soporte de eje ø 8x8mm L 170mm An 40mm H 40mm		

			
1			
código	692720	referencia	3101630
descripción	junta para cierre de puerta PTFE D1 ø 26mm D2 ø 11.7mm espesor 2mm		
Para modelos:	FX201E2, FX201E2P, FX201E2P-VERS.032014, FX201E2-VERS.032014, FX201E3, FX201E3P, FX201E3P-VERS.022014, FX201E3-VERS.022014, FX201G2, FX201G2P, FX201G2P-VERS.032014, FX201G2-VERS.032014, FX201G3P, FX201G3-VERS.022014, FX202E2, FX202E2-VERS.032014, FX202E3, FX202E3-230V-3-50Hz-60Hz, FX202E3-230V-3-50Hz-60Hz-VERS.022014, FX202E3-VERS.022014, FX202G2, FX202G2-VERS.032014, FX202G3, FX202G3-VERS.022014		

			
1			
código	694631	referencia	3104201 3104202 3104203
descripción	manilla de puerta para horno a vapor combinado L 210mm An 170mm H 55mm plata plástico		
Para modelos:	FX101E1, FX101E2, FX101E2C, FX101E2C-VERS.032014, FX101E2-VERS.032014, FX101E3, FX101E3C, FX101E3C-VERS.022014, FX101E3R, FX101E3-VERS.022014, FX101G1, FX101G2, FX101G2C, FX101G2C-VERS.032014, FX101G2-VERS.032014, FX101G3, FX101G3C, FX101G3C-VERS.022014, FX101G3-VERS.022014, FX10E2CR-VERS.032014, FX122E1, FX122E2, FX122E2C, FX122E2T, FX122E2T-VERS.032014, FX122E3, FX122E3C, FX122E3T, FX122E3T-VERS.022014, FX122G1, FX122G3, FX122G3C, FX122G3T, FX122G3T-VERS.022014, FX12E3CT, FX12E3CT-VERS.022014, FX12G3CT, FX12G3CT-VERS.022014, FX201E2, FX201E2P, FX201E2P-VERS.032014, FX201E2-VERS.032014, FX201E3, FX201E3P, FX201E3P-VERS.022014, FX201E3-VERS.022014, FX201G2, FX201G2P, FX201G2P-VERS.032014, FX201G2-VERS.032014...(Otros modelos se puede ver en la tienda web)		

			
1			
código	692718	referencia	3104152 3104153
descripción	tapa ø 38.5mm		
Para modelos:	FX101E1, FX101E2, FX101E2C, FX101E2C-VERS.032014, FX101E2-VERS.032014, FX101E3, FX101E3C, FX101E3C-VERS.022014, FX101E3R, FX101E3-VERS.022014, FX101G1, FX101G2, FX101G2C, FX101G2C-VERS.032014, FX101G2-VERS.032014, FX101G3, FX101G3C, FX101G3C-VERS.022014, FX101G3-VERS.022014, FX10E2CR-VERS.032014, FX122E1, FX122E2, FX122E2C, FX122E2T, FX122E2T-VERS.032014, FX122E3, FX122E3C, FX122E3T, FX122E3T-VERS.022014, FX122G1, FX122G3, FX122G3C, FX122G3T, FX122G3T-VERS.022014, FX12E3CT, FX12E3CT-VERS.022014, FX12G3CT, FX12G3CT-VERS.022014, FX201E2, FX201E2P, FX201E2P-VERS.032014, FX201E2-VERS.032014, FX201E3, FX201E3P, FX201E3P-VERS.022014, FX201E3-VERS.022014, FX201G2, FX201G2P, FX201G2P-VERS.032014, FX201G2-VERS.032014...(Otros modelos se puede ver en la tienda web)		

otros

			
1			
código	518585	referencia	36M1240
descripción	reten		

bisagras

bandas de bisagras

universal

1



código	692866	referencia	3085860
descripción	bisagra L 25mm distancia de sujeción 14mm agujero ø 3mm espesor 1mm		
Para modelos:	BX101E, BX101E-VERS.122013, BX101G, BX101G-VERS.122013, BX122E, BX122E-VERS.122013, BX122G, BX122G-VERS.122013, BX61E, BX61E-VERS.122013, BX61G, BX61G-VERS.122013, BX82E, BX82E-VERS.122013, BX82G, BX82G-VERS.122013, FX101E1, FX101E1R, FX101E2, FX101E2C, FX101E2C-VERS.032014, FX101E2R, FX101E2R-VERS.032014, FX101E2-VERS.032014, FX101E3, FX101E3C, FX101E3C-VERS.022014, FX101E3R, FX101E3R-VERS.022014, FX101E3-VERS.022014, FX101G1, FX101G1R, FX101G2, FX101G2C, FX101G2C-VERS.032014, FX101G2R, FX101G2R-VERS.032014, FX101G2-VERS.032014, FX101G3, FX101G3C, FX101G3C-VERS.022014, FX101G3R, FX101G3R-VERS.022014, FX101G3-VERS.022014, FX10E2CR, FX10E2CR-VERS.032014, FX10E3CR, FX10E3CR-VERS.022014, FX10G2CR, FX10G2CR-VERS.032014...(Otros modelos se puede ver en la tienda web)		

INTERKLIMAT

bisagras

1

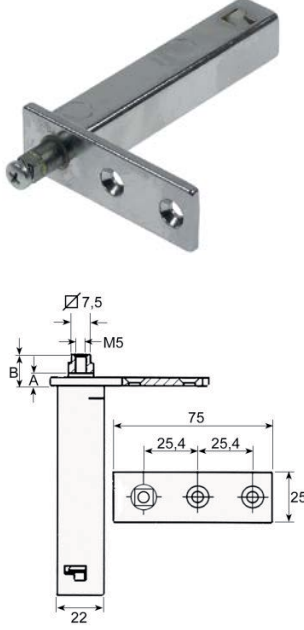

código	690622	referencia	36G6520
descripción	bisagra a resorte serie 28L pos. de montaje izquierdo/derecho L 75mm An 25mm H 103mm A 13mm B 18mm medida de montaje 22x22mm soporte 7,5x7,5 aparatos de refrigeración		

bisagras de resorte

universal

CAFF/FERMOD

grupo 2

1

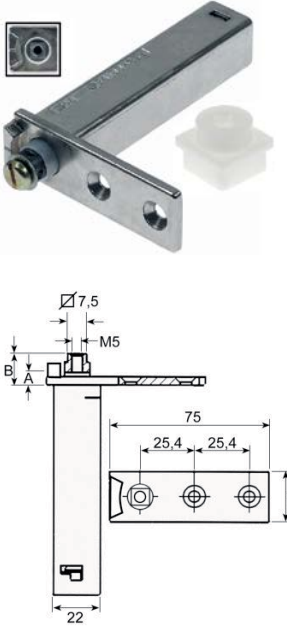

código	690574	referencia	36M2460
descripción	bisagra a resorte serie 176 pos. de montaje izquierdo/derecho L 75mm An 25.6mm A 11mm B 15mm medida de montaje 22x22mm soporte 7,5x7,5		

accesorios

1



código	690747	referencia	3178300
descripción	casquillo para bisagra int.ø 7.5mm L 25.5mm An 25.5mm blanco medida de montaje 22x22mm H 4.5mm		
Para modelos:	120, 120B, 120NN, 135, 135-4, 135A, 135B, 135BA, 135BN, 135BNX, 135BX, 135BXE, 135BXR, 135CPX, 135NN, 135NNX, 135X, 135X-3, 135X-4, 135XE, 135XR, 55, 55B, 65, 65A, 65B, 65BA, 65BX, 65BX-2, 65BXE, 65BXR, 65NB, 65NBX, 65NN, 65NNX, 65X, 65X-2, 65XE, 65XR, AF1B, AF1N, AF2B, AF2N, ART1L, ART1LA, ART1LD, ART1LDA, ART2LD, ART2SD, ART3SD...(Otros modelos se puede ver en la tienda web)		

específico del fabricante

ANGELO PO

1





código	691198	referencia	36G2650
descripción	barra para bisagra a resorte L 345mm ø 12mm		
Para modelos:	191PD1G, 191PD2G, 191PI1G, 191PI1GA, 191PI2E, 191PI2EA, 191PI2G, 191PI2GA, 191PI2V, 191PI2VA, 1A1PD1G, 1A1PD2G, 1A1PI1G, 1A1PI1GA, 1A1PI2E, 1A1PI2EA, 1A1PI2G, 1A1PI2GA, 1A1PI2V, 1A1PI2VA, 1D1PD1G, 1D1PD2G, 1D1PI1G, 1D1PI1GA, 1D1PI2E, 1D1PI2EA, 1D1PI2G, 1D1PI2GA, 1D1PI2V, 1D1PI2VA, 1G1BR1E, 1G1BR1G, 1G1PD1G, 1G1PI1E, 1G1PI1G, 31PD6, 31PI6, 31PIE6, 31R, 31RE, 71AR, 71ARE, 71PD10, 71PD15, 71PI10, 71PI10A, 71PIE15, 71PIE15A, 71PV15, 71PV15A...(Otros modelos se puede ver en la tienda web)		

			
1			
código	690674	referencia	6008490
descripción	bisagra a resorte derecho L 128mm espesor de resorte 2.5mm		
Para modelos:	135PVX, 55PV		

			
1			
código	690572	referencia	36M0340
descripción	bisagra a resorte derecho refrigerador apto para SAGI		

			
1			
código	690675	referencia	6008500
descripción	bisagra a resorte izquierdo		
Para modelos:	135PVX		

			
1			
código	690573	referencia	30M0350 36M0350
descripción	bisagra a resorte izquierdo refrigerador apto para SAGI		

			
1			
código	690747	referencia	3178300
descripción	casquillo para bisagra int.ø 7.5mm L 25.5mm An 25.5mm blanco medida de montaje 22x22mm H 4.5mm		
Para modelos:	120, 120B, 120NN, 135, 135-4, 135A, 135B, 135BA, 135BN, 135BNX, 135BX, 135BXE, 135BXR, 135CPX, 135NN, 135NNX, 135X, 135X-3, 135X-4, 135XE, 135XR, 55, 55B, 65, 65A, 65B, 65BA, 65BX, 65BX-2, 65BXE, 65BXR, 65NB, 65NBX, 65NN, 65NNX, 65X, 65X-2, 65XE, 65XR, AF1B, AF1N, AF2B, AF2N, ART1L, ART1LA, ART1LD, ART1LDA, ART2LD, ART2SD, ART3SD...(Otros modelos se puede ver en la tienda web)		

			
1			
código	691186	referencia	36D2790
descripción	soporte de bisagra pos. de montaje derecho		
Para modelos:	31PD6, 31PI6, 31PIE6, 31R, 31RE, 71AR, 71ARE, 71PD10, 71PD15, 71PI10, 71PI10A, 71PIE15, 71PIE15A, 71PV15, 71PV15A, 71RA, 91AR, 91ARE, 91PI10, 91PI10A, 91PIE15, 91PIE15A, 91RA		

			
1			
código	691185	referencia	36D2800
descripción	soporte de bisagra pos. de montaje izquierdo		
Para modelos:	31PD6, 31PI6, 31PIE6, 31R, 31RE, 71AR, 71ARE, 71PD10, 71PD15, 71PI10, 71PI10A, 71PIE15, 71PIE15A, 71PV15, 71PV15A, 71RA, 91AR, 91ARE, 91PI10, 91PI10A, 91PIE15, 91PIE15A, 91RA		

ELECTROLUX/ZANUSSI

			
1			
código	690747	referencia	3178300
descripción	casquillo para bisagra int.ø 7.5mm L 25.5mm An 25.5mm blanco medida de montaje 22x22mm H 4.5mm		
Para modelos:	120, 120B, 120NN, 135, 135-4, 135A, 135B, 135BA, 135BN, 135BNX, 135BX, 135BXE, 135BXR, 135CPX, 135NN, 135NNX, 135X, 135X-3, 135X-4, 135XE, 135XR, 55, 55B, 65, 65A, 65B, 65BA, 65BX, 65BX-2, 65BXE, 65BXR, 65NB, 65NBX, 65NN, 65NNX, 65X, 65X-2, 65XE, 65XR, AF1B, AF1N, AF2B, AF2N, ART1L, ART1LA, ART1LD, ART1LDA, ART2LD, ART2SD, ART3SD...(Otros modelos se puede ver en la tienda web)		

SAGI

			
1			
código	691198	referencia	36G2650
descripción	barra para bisagra a resorte L 345mm ø 12mm		
Para modelos:	191PD1G, 191PD2G, 191PI1G, 191PI1GA, 191PI2E, 191PI2EA, 191PI2G, 191PI2GA, 191PI2V, 191PI2VA, 1A1PD1G, 1A1PD2G, 1A1PI1G, 1A1PI-1GA, 1A1PI2E, 1A1PI2EA, 1A1PI2G, 1A1PI2GA, 1A1PI2V, 1A1PI2VA, 1D1PD1G, 1D1PD2G, 1D1PI1G, 1D1PI1GA, 1D1PI2E, 1D1PI2EA, 1D1PI2G, 1D1PI2GA, 1D1PI2V, 1D1PI2VA, 1G1BR1E, 1G1BR1G, 1G1PD1G, 1G1PI1E, 1G1PI1G, 31PD6, 31PI6, 31PIE6, 31R, 31RE, 71AR, 71ARE, 71PD10, 71PD15, 71PI10, 71PI10A, 71PIE15, 71PIE15A, 71PV15, 71PV15A...(Otros modelos se puede ver en la tienda web)		

			
1			
código	690674	referencia	6008490
descripción	bisagra a resorte derecho L 128mm espesor de resorte 2.5mm		
Para modelos:	135PVX, 55PV		

bisagras para hornos



1

código	690572	referencia	36M0340
descripción	bisagra a resorte derecho refrigerador apto para SAGI		



1

código	690675	referencia	6008500
descripción	bisagra a resorte izquierdo		
Para modelos:	135PVX		



1

código	690573	referencia	30M0350 36M0350
descripción	bisagra a resorte izquierdo refrigerador apto para SAGI		



1

código	690747	referencia	3178300
descripción	casquillo para bisagra int.ø 7.5mm L 25.5mm An 25.5mm blanco medida de montaje 22x22mm H 4.5mm		
Para modelos:	120, 120B, 120NN, 135, 135-4, 135A, 135B, 135BA, 135BN, 135BNX, 135BX, 135BXE, 135BXR, 135CPX, 135NN, 135NNX, 135X, 135X-3, 135X-4, 135XE, 135XR, 55, 55B, 65, 65A, 65B, 65BA, 65BX, 65BX-2, 65BXE, 65BXR, 65NB, 65NBX, 65NN, 65NNX, 65X, 65X-2, 65XE, 65XR, AF1B, AF1N, AF2B, AF2N, ART1L, ART1LA, ART1LD, ART1LDA, ART2LD, ART2SD, ART3SD...(Otros modelos se puede ver en la tienda web)		



1

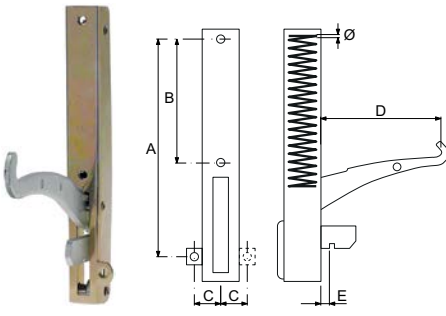

código	700704 ¹	referencia	36M0190
descripción	bisagra para horno distancia de sujeción 120mm orejas de fijación 13mm longitud de palanca 115mm distancia de ranura 7mm espesor de resorte 2.2mm posición fijación izquierdo/derecho longitud muelle 52mm An 27mm		

¹con contrasorte



1

código	700007	referencia	36M0110 36M2430
descripción	bisagra para horno distancia de sujeción 173mm distancia de sujeción 2 105mm orejas de fijación 14mm longitud de palanca 120mm distancia de ranura 11mm espesor de resorte 3.5mm posición fijación derecho longitud muelle 112mm An 25mm		
Para modelos:	08WFA4E, 08WFA4G, 08WFAAE, 08WFAAG, 10WTPGE, 12WFA6E, 12WFA6G, 12WFAAE, 12WFAAG, 191FAAE, 191FAAG, 191FABG, 191FADG, 191FAE, 191FAG, 191PE4E, 191TPG, 1A1FA1G, 1A1FA2G, 1A1FA4G, 1A1FA5G, 1A1FAAG, 1A1FABG, 1A1FAS2G, 1A1FASG, 1A1PE4E, 1A1PEFTE, 1A1TP0G, 1A1TP0G-VERS.2002, 1AIFBE, 1B1FAS2G, 1B1FASG, 1D1FA1G, 1D1FA2G, 1D1FA4G, 1D1FA5G, 1D1FAAG, 1D1FABG, 1D1FAS2G, 1D1FASG, 1D1PE4E, 1D1TP0G, 1D1TP0G-VERS.2002, 1DIFBE, 1G1FA0E, 1G1FA0EV, 1G1FA0G, 1G1FA0GV, 1G1FABG, 1G1FAPG...(Otros modelos se puede ver en la tienda web)		
accesorios para	700007		
		código	700001
		referencia	3094780 36M0120 36M0270
	contrasorte L 118mm An 17mm distancia de sujeción 94mm		

			
código	700006	referencia	36M0100 36M2420
descripción	bisagra para horno distancia de sujeción 173mm distancia de sujeción 2 105mm orejas de fijación 14mm longitud de palanca 120mm distancia de ranura 11mm espesor de resorte 3.5mm posición fijación izquierdo longitud muelle 112mm An 25mm		
Para modelos:	08WFA4E, 08WFA4G, 08WFAAE, 08WFAAG, 10WTPGE, 12WFA6E, 12WFA6G, 12WFAAE, 12WFAAG, 191FAAE, 191FAAG, 191FABG, 191FADG, 191FAE, 191FAG, 191PE4E, 191TPG, 1A1FA1G, 1A1FA2G, 1A1FA4G, 1A1FA5G, 1A1FAAG, 1A1FABG, 1A1FAS2G, 1A1FASG, 1A1PE4E, 1A1PEFTE, 1A1TP0G, 1A1TP0G-VERS.2002, 1AIFBE, 1B1FAS2G, 1B1FASG, 1D1FA1G, 1D1FA2G, 1D1FA4G, 1D1FA5G, 1D1FAAG, 1D1FABG, 1D1FAS2G, 1D1FASG, 1D1PE4E, 1D1TP0G, 1D1TP0G-VERS.2002, 1DIFBE, 1G1FA0E, 1G1FA0EV, 1G1FA0G, 1G1FA0GV, 1G1FABG, 1G1FAPG...(Otros modelos se puede ver en la tienda web)		
accesorios para	700006		
			
código	700001	referencia	3094780 36M0120 36M0270
descripción	contrasopORTE L 118mm An 17mm distancia de sujeción 94mm		
			
código	700007	referencia	36M0110 36M2430
descripción	bisagra para horno distancia de sujeción 173mm distancia de sujeción 2 105mm orejas de fijación 14mm longitud de palanca 120mm distancia de ranura 11mm espesor de resorte 3.5mm posición fijación derecho longitud muelle 112mm An 25mm		

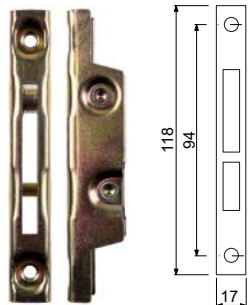
			
código	700001	referencia	3094780 36M0120 36M0270
descripción	contrasopORTE L 118mm An 17mm distancia de sujeción 94mm		
Para modelos:	08WFA4E, 08WFA4G, 08WFAAE, 08WFAAG, 10WTPGE, 12WFA6E, 12WFA6G, 12WFAAE, 12WFAAG, 191FAAE, 191FAAG, 191FABG, 191FADG, 191FAE, 191FAG, 191PE4E, 191TPG, 1A1FA1G, 1A1FA2G, 1A1FA4G, 1A1FA5G, 1A1FAAG, 1A1FABG, 1A1FAS2G, 1A1FASG, 1A1PE4E, 1A1PEFTE, 1A1TP0G, 1A1TP0G-VERS.2002, 1AIFBE, 1B1FAS2G, 1B1FASG, 1D1FA1G, 1D1FA2G, 1D1FA4G, 1D1FA5G, 1D1FAAG, 1D1FABG, 1D1FAS2G, 1D1FASG, 1D1PE4E, 1D1TP0G, 1D1TP0G-VERS.2002, 1DIFBE, 1G1FA0E, 1G1FA0EV, 1G1FA0G, 1G1FA0GV, 1G1FABG, 1G1FAPG...(Otros modelos se puede ver en la tienda web)		

			
código	109720	referencia	35U3170
descripción	cubierta distancia de sujeción 94mm L 124mm An 20mm bisagra para horno		
Para modelos:	08WFA4E, 08WFA4G, 08WFAAE, 08WFAAG, 10WTPGE, 12WFA6E, 12WFA6G, 12WFAAE, 12WFAAG, 191FAAE, 191FAAG, 191FABG, 191FADG, 191FAE, 191FAG, 191PE4E, 191TPG, 1A1FA1G, 1A1FA2G, 1A1FA4G, 1A1FA5G, 1A1FAAG, 1A1FABG, 1A1FAS2G, 1A1FASG, 1A1PE4E, 1A1PEFTE, 1A1TP0G, 1A1TP0G-VERS.2002, 1AIFBE, 1B1FAS2G, 1B1FASG, 1D1FA1G, 1D1FA2G, 1D1FA4G, 1D1FA5G, 1D1FAAG, 1D1FABG, 1D1FAS2G, 1D1FASG, 1D1PE4E, 1D1TP0G, 1D1TP0G-VERS.2002, 1DIFBE, 1G1FA0E, 1G1FA0EV, 1G1FA0G, 1G1FA0GV, 1G1FAPG, 1G1PE1E...(Otros modelos se puede ver en la tienda web)		

soporte de puerta

			
código	690563	referencia	3AG0040
descripción	bisagra		

			
código	690489	referencia	30T5910
descripción	bisagra L 138mm pos. de montaje arriba/abajo		
Para modelos:	135-4, 135CPX, 135X-3, 135X-4, 65BX-2, 65NB, 65NBX, 65NN, 65NNX, 65X-2, S125-4, S125B-4, S125BX-4, S125X-4, S60-2, S60B-2, S60BX-2, S60X-2, SP135CP, SP65NB, SP65NN		

			
código	700740	referencia	3043190 3088700
descripción	bisagra pos. de montaje abajo		
Para modelos:	3G6SA, 3G6SA2, 3G6SA4, 4G6SB, 4G6SB2, 4G6SB4, 4G6SB6, 6BR15V, 6BR15VC, 6BR19V, 6BR19VC, 6EA, 6EA11, 6EA11A, 6EA11M, 6EA13, 6EA13A, 6EA13M, 6EA2, 6EA2A, 6EA2M, 6EAA, 6EAB, 6EABA, 6EABM, 6EAM, 6EB, 6EB11, 6EB11A, 6EB11M, 6EB13, 6EB13A, 6EB13M, 6EB2, 6EB22, 6EB22A, 6EB22M, 6EB2A, 6EB2M, 6EB4, 6EB4A, 6EB4M, 6EBA, 6EBB, 6EBBA, 6EBBM, 6EBM, 6EC, 6EC11, 6EC11A...(Otros modelos se puede ver en la tienda web)		



1

código	690793	referencia	30T4780
descripción	bisagra pos. de montaje abajo derecha		
Para modelos:	120PV, 135PVX, 55PV, 65PVX		



1

código	695570	referencia	36M2490
descripción	bisagra pos. de montaje abajo izquierda		
Para modelos:	71CP, 71CP2, 71F, 71F2, 71F2B, 71FE, 71FE2, 71FE2B, 91CP, 91F210, 91F210B, 91F223B		



1

código	700741	referencia	3043180
descripción	bisagra pos. de montaje arriba		
Para modelos:	3G6SA, 3G6SA2, 3G6SA4, 4G6SB, 4G6SB2, 4G6SB4, 4G6SB6, 6BR15V, 6BR15VC, 6BR19V, 6BR19VC, 6EA, 6EA11, 6EA11A, 6EA11M, 6EA13, 6EA13A, 6EA13M, 6EA2, 6EA2A, 6EA2M, 6EAA, 6EAB, 6EABA, 6EABM, 6EAM, 6EB, 6EB11, 6EB11A, 6EB11M, 6EB13, 6EB13A, 6EB13M, 6EB2, 6EB22, 6EB22A, 6EB22M, 6EB2A, 6EB2M, 6EB4, 6EB4A, 6EB4M, 6EBA, 6EBB, 6EBBA, 6EBBM, 6EBM, 6EC, 6EC11, 6EC11A...(Otros modelos se puede ver en la tienda web)		



1

código	690790	referencia	30T1080
descripción	bisagra pos. de montaje arriba derecha		



1

código	700719	referencia	36M2541
descripción	bisagra pos. de montaje arriba derecha		
Para modelos:	30CPS, 30CPSE, 30F1, 30F1B, 30FES2, 30FES2B, 30FS2, 30FS2B, 32TC, 32TCE, 32TPV, 32V, 70CP, 70CPE, 70F, 70F1, 70F1B, 70FE, 70FE1, 70FE1B, 70FES, 70FES2, 70FES2B, 71CP, 71CP2, 71F, 71F2, 71F2B, 71FE, 71FE2, 71FE2B, 72D, 72DGG, 72TP, 72TPGG, 72VA, 72VAGG, 72VAS, 72VASGG, 90CP, 90CPE, 90F110B, 91CP, 91F210, 91F210B, 91F223B		



1

código	690787	referencia	30T1980
descripción	bisagra pos. de montaje arriba izquierda		



1

código	690794	referencia	30T4800
descripción	bisagra pos. de montaje arriba izquierda		
Para modelos:	120PV, 135PVX		



1

código	690788	referencia	36M0320 36M2610
descripción	bisagra pos. de montaje centrado con perno		



1

código	505512	referencia	30T1340
descripción	bisagra a resorte derecho		
Para modelos:	F60P, F60PR, F60T, F80P, F80PR		



1

código	505513	referencia	30T1350
descripción	bisagra a resorte izquierdo		
Para modelos:	F60P, F60PR, F60T, F80P, F80PR		



			
1			
código	691157	referencia	30T2000
descripción	bisagra de puerta pos. de montaje abajo derecha		

			
1			
código	690479	referencia	3170250
descripción	casquillo H 20mm ø 7mm medida de montaje 22x22mm dimensiones exteriores 26,5x26,5mm		
Para modelos:	135-4, 135CPX, 135X-3, 135X-4, 65BX-2, 65NB, 65NBX, 65NN, 65NNX, 65X-2, SP135CP, SP65NB, SP65NN		

			
1			
código	690686	referencia	36G2810
descripción	casquillo para bisagra de puerta batiente		
Para modelos:	40, 40B, 40CP, 40CPX, 40PL, 40X, ART1L7, ART1L7A, ART1L7M, ART1LD7, ART1LD7A, ART1LD7M, BRPR, BRPR218, BRPR21C, BRPRV, BRVR, BRVR218, BRVR21C, BRVRV, K16APGPZ, K16XPZAP, SA16AGB, SA16GB, SA87, SM03LT7, SM03LT7A, SM03LT7M, SM1L7, SM1L7A, SM1L7FCV, SM1L7M, SM1LT7, SM1LT7A, SM1LT7M		

			
1			
código	690742	referencia	36D4610
descripción	casquillo para bisagra de puerta batiente		
Para modelos:	6BEA11Z, 6BEA2Z, 6BEA3Z, 6BEABA, 6BEABB, 6BEABM, 6BEABZ, 6BEAZ, 6BEB11Z, 6BEB22Z, 6BEB2Z, 6BEB3Z, 6BEB4Z, 6BEBBA, 6BEBB, 6BEBBM, 6BEBBZ, 6BEBZ, 6BEC11Z, 6BEC22Z, 6BEC2Z, 6BEC33Z, 6BEC3Z, 6BEC4Z, 6BEC6Z, 6BECBA, 6BECBB, 6BECBM, 6BECBZ, 6BECZ, 6BMA11A, 6BMA11B, 6BMA11M, 6BMA11Z, 6BMA2A, 6BMA2B, 6BMA2M, 6BMA2Z, 6BMA3A, 6BMA3B, 6BMA3M, 6BMA3Z, 6BMAA, 6BMAB, 6BMABA, 6BMABB, 6BMABM, 6BMABZ, 6BMAM, 6BMAZ... (Otros modelos se puede ver en la tienda web)		

			
1			
código	690743	referencia	36D4700
descripción	casquillo para bisagra de puerta batiente		
Para modelos:	6BEA11Z, 6BEA2Z, 6BEA3Z, 6BEABA, 6BEABB, 6BEABM, 6BEABZ, 6BEAZ, 6BEB11Z, 6BEB22Z, 6BEB2Z, 6BEB3Z, 6BEB4Z, 6BEBBA, 6BEBB, 6BEBBM, 6BEBBZ, 6BEBZ, 6BEC11Z, 6BEC22Z, 6BEC2Z, 6BEC33Z, 6BEC3Z, 6BEC4Z, 6BEC6Z, 6BECBA, 6BECBB, 6BECBM, 6BECBZ, 6BECZ, 6BMA11Z, 6BMA2Z, 6BMA3Z, 6BMABA, 6BMABB, 6BMABM, 6BMABZ, 6BMAZ, 6BMB11Z, 6BMB22Z, 6BMB2Z, 6BMB3Z, 6BMB4Z, 6BMBBZ, 6BMBZ, 6BMC11Z, 6BMC22Z, 6BMC2Z, 6BMC33Z, 6BMC3Z... (Otros modelos se puede ver en la tienda web)		

			
1			
código	695571	referencia	36M0090
descripción	casquillo para bisagra de puerta batiente		
Para modelos:	135-4, 135CPX, 135X-3, 135X-4, 65BX-2, 65NB, 65NBX, 65NN, 65NNX, 65X-2, CX140CP, CX150CP, CX652, CX65NB, CX65NCP, CX65NN, CX702, CX70NB, CX70NN, FSD2B2-OPR01, FSD2N2, FSD2N2-OPR01, FSDR2B2-OPR01, FSE2B2, FSE2B2-OPR01, FSE2N2, FSE2N2-OPR01, FSER2B2-OPR01, FSER2N2-OPR01, ISFEB, ISFEB-OPR01, ISFEN, ISFEN-OPR01, MD1504, MD150B4, MD702, MD70B2, MD70NB, MD70NCP, MD70NN, PD150CP, PD702, PD70B2, S12004, S1200B4, S125-4, S125B-4, S125BX-4, S125X-4, S6002... (Otros modelos se puede ver en la tienda web)		

			
1			
código	690571	referencia	30T5810
descripción	cojinete giratorio con perno apto para SAGI		
Para modelos:	120, 120B, 120NN, 135, 135A, 135B, 135BA, 135BN, 135BNX, 135BX, 135BXE, 135BXR, 135CPX, 135NN, 135NNX, 135X, 135X-3, 135XE, 135XR, 55, 55B, 65, 65A, 65B, 65BA, 65BX, 65BXE, 65BXR, 65X, 65XE, 65XR, S125, S125B, S125BE, S125BX, S125E, S125X, S60, S60B, S60BE, S60BX, S60E, S60X, SP120, SP120B, SP120BN, SP120NN, SP135, SP135B, SP135BN... (Otros modelos se puede ver en la tienda web)		

			
1			
código	690751	referencia	30T2051
descripción	cojinete giratorio con perno apto para SAGI		
Para modelos:	K16APGPZ, K16XPZAP, SA16AGB, SA16GB		



código	690741	referencia	30T6230
descripción	cojinete giratorio pos. de montaje abajo con perno		
Para modelos:	6BEA11Z, 6BEA2Z, 6BEA3Z, 6BEABA, 6BEABB, 6BEABM, 6BEABZ, 6BEAZ, 6BEB11Z, 6BEB2Z, 6BEB2Z, 6BEB3Z, 6BEB4Z, 6BEBBA, 6BEBB, 6BEBBM, 6BEBBZ, 6BEBZ, 6BEC11Z, 6BEC2Z, 6BEC2Z, 6BEC3Z, 6BEC3Z, 6BEC4Z, 6BEC6Z, 6BECBA, 6BECBB, 6BECBM, 6BECBZ, 6BECZ, 6BMA11Z, 6BMA2Z, 6BMA3Z, 6BMABA, 6BMABB, 6BMABM, 6BMABZ, 6BMAZ, 6BMB11Z, 6BMB2Z, 6BMB2Z, 6BMB3Z, 6BMB4Z, 6BMBBA, 6BMBBB, 6BMBBM, 6BMBBZ, 6BMBZ, 6BMC11Z, 6BMC2Z...(Otros modelos se puede ver en la tienda web)		



código	690755	referencia	30T1950
descripción	cojinete giratorio pos. de montaje abajo con perno		



código	690749	referencia	36M2740
descripción	cojinete giratorio pos. de montaje abajo sin perno		
Para modelos:	K16APGPZ, K16XPZAP, SA16AGB, SA16GB		



código	690740	referencia	30T6220
descripción	cojinete giratorio pos. de montaje arriba con perno		
Para modelos:	6BEA11Z, 6BEA2Z, 6BEA3Z, 6BEABA, 6BEABB, 6BEABM, 6BEABZ, 6BEAZ, 6BEB11Z, 6BEB2Z, 6BEB2Z, 6BEB3Z, 6BEB4Z, 6BEBBA, 6BEBB, 6BEBBM, 6BEBBZ, 6BEBZ, 6BEC11Z, 6BEC2Z, 6BEC2Z, 6BEC3Z, 6BEC3Z, 6BEC4Z, 6BEC6Z, 6BECBA, 6BECBB, 6BECBM, 6BECBZ, 6BECZ, 6BMA11Z, 6BMA2Z, 6BMA3Z, 6BMABA, 6BMABB, 6BMABM, 6BMABZ, 6BMAZ, 6BMB11Z, 6BMB2Z, 6BMB2Z, 6BMB3Z, 6BMB4Z, 6BMBBA, 6BMBBB, 6BMBBM, 6BMBBZ, 6BMBZ, 6BMC11Z, 6BMC2Z...(Otros modelos se puede ver en la tienda web)		



código	690671	referencia	30T5800
descripción	cojinete giratorio pos. de montaje arriba derecha con perno		
Para modelos:	120PV, 135PVX, 55PV, 65PVX		



código	690748	referencia	36M2730
descripción	cojinete giratorio pos. de montaje arriba derecha con perno		
Para modelos:	K16APGPZ, K16XPZAP, SA16AGB, SA16GB		



código	690672	referencia	30T5970
descripción	cojinete giratorio pos. de montaje arriba izquierda con perno		
Para modelos:	120PV, 135PVX		



código	690792	referencia	30T4810
descripción	cojinete giratorio pos. de montaje arriba izquierda con perno		



código	690684	referencia	35V7760
descripción	cojinete giratorio pos. de montaje arriba sin perno		
Para modelos:	40, 40B, 40CP, 40CPX, 40PL, 40X		



código	690688	referencia	35V8800
descripción	cojinete giratorio pos. de montaje arriba sin perno		
Para modelos:	40EV, 40EVP, 40PV, 40XPV		



1

código	690746	referencia	30T5900
descripción	cojinete giratorio pos. de montaje centrado con perno		
Para modelos:	135-4, 135CPX, 135X-3, 135X-4, 65BX-2, 65NB, 65NBX, 65NN, 65NNX, 65X-2, S125-4, S125B-4, S125BX-4, S125X-4, S60-2, S60B-2, S60BX-2, S60X-2, SP135CP, SP65NB, SP65NN		



1

código	514282	referencia	36M4122
descripción	cojinete giratorio pos. de montaje derecho/izquierdo sin perno		
Para modelos:	FC101, FC101E, FC241, FC241E, FC241G, FC61, FC61E, FCV101, FCV101-CSA, FCV101DM, FCV101DM-CSA, FCV101DS, FCV101DS-CSA, FCV101E, FCV101EDM, FCV101EDM-UL, FCV101EDS, FCV101EDS-UL, FCV101E-UL, FCV141, FCV141-CSA, FCV141DM, FCV141DM-CSA, FCV141DS, FCV141DS-CSA, FCV141E, FCV141EDM, FCV141EDS, FCV241, FCV241DM, FCV241DS, FCV241E, FCV241EDM, FCV241EDM-UL, FCV241EDS, FCV241EDS-UL, FCV241E-UL, FCV241G, FCV241G-CSA, FCV241GDM, FCV241GDM-CSA, FCV241GDS, FCV241GDS-CSA, FCV3EM, FCV401DM, FCV401DM-CSA, FCV401EDM, FCV401EDM-UL, FCV4E, FCV4EDS...(Otros modelos se puede ver en la tienda web)		



1

código	692862	referencia	3108730
descripción	cojinete giratorio sin perno pos. de montaje abajo derecha		
Para modelos:	BX101E, BX101E-VERS.122013, BX101G, BX101G-VERS.122013, BX122E, BX122E-VERS.122013, BX122G, BX122G-VERS.122013, BX61E, BX61E-VERS.122013, BX61G, BX61G-VERS.122013, BX82E, BX82E-VERS.122013, BX82G, BX82G-VERS.122013, FX101E1, FX101E1R, FX101E2, FX101E2C, FX101E2C-VERS.032014, FX101E2R, FX101E2R-VERS.032014, FX101E2-VERS.032014, FX101E3, FX101E3C, FX101E3C-VERS.022014, FX101E3R, FX101E3R-VERS.022014, FX101E3-VERS.022014, FX101G1, FX101G1R, FX101G2, FX101G2C, FX101G2C-VERS.032014, FX101G2R, FX101G2R-VERS.032014, FX101G2-VERS.032014, FX101G3, FX101G3C, FX101G3C-VERS.022014, FX101G3R, FX101G3R-VERS.022014, FX101G3-VERS.022014, FX10E2CR, FX10E2CR-VERS.032014, FX10E3CR, FX10E3CR-VERS.022014, FX10G2CR, FX10G2CR-VERS.032014...(Otros modelos se puede ver en la tienda web)		



1

código	692861	referencia	36E2680
descripción	cojinete giratorio sin perno pos. de montaje arriba derecha		
Para modelos:	FC1011E, FC1011G, FC1221E, FC1221G, FC611E, FC611G, FM1011E1, FM1011E1-VERS.2006, FM1011E2, FM1011E2-VERS.2006, FM1011E3, FM1011E3-VERS.2006, FM1011G1, FM1011G1-VERS.2006, FM1011G2, FM1011G2-VERS.2006, FM1011G3, FM1011G3-VERS.2006, FM1221E1, FM1221E1-VERS.2006, FM1221E2, FM1221E2-VERS.2006, FM1221E3, FM1221E3-VERS.2006, FM1221G1, FM1221G1-VERS.2006, FM1221G2, FM1221G2-VERS.2006, FM1221G3, FM1221G3-VERS.2006, FM2011E2-VERS.2006, FM2011E3-VERS.2006, FM2011G2-VERS.2006, FM2011G3-VERS.2006, FM2021E1, FM2021E2, FM2021E2-VERS.2006, FM2021E3, FM2021E3-VERS.2006, FM2021G1, FM2021G2, FM2021G2-VERS.2006, FM2021G3, FM2021G3-VERS.2006, FM611E1, FM611E1-VERS.2006, FM611E2, FM611E2-VERS.2006, FM611E3, FM611E3-VERS.2006...(Otros modelos se puede ver en la tienda web)		



1

código	690795	referencia	36D9490
descripción	contrapieza para bisagra a resorte		
Para modelos:	120, 120B, 120NN, 135, 135-4, 135A, 135B, 135BA, 135BN, 135BNX, 135BX, 135BXE, 135BXR, 135CPX, 135NN, 135NNX, 135X, 135X-3, 135X-4, 135XE, 135XR, 55, 55B, 65, 65A, 65B, 65BA, 65BX, 65BX-2, 65BXE, 65BXR, 65NB, 65NBX, 65NN, 65NNX, 65X, 65X-2, 65XE, 65XR, ART1L, ART1LA, ART1LD, ART1LDA, ART2LD, ART2SD, ART3SD, S125, S125-4, S125B, S125B-4...(Otros modelos se puede ver en la tienda web)		

otros



1

código	700715	referencia	30T3150
descripción	bisagra pos. de montaje izquierdo/derecho		
Para modelos:	L45		

			
1			
código	698474	referencia	36E2820
descripción	bloque de bisagras longitud total 50mm altura total 14mm apto para ANGELO PO		
Para modelos:	FC1011E, FC1011G, FC1221E, FC1221G, FC611E, FC611G, FM1011E1, FM1011E1-VERS.2006, FM1011E2, FM1011E2-VERS.2006, FM1011E3, FM1011E3-VERS.2006, FM1011G1, FM1011G1-VERS.2006, FM1011G2, FM1011G2-VERS.2006, FM1011G3, FM1011G3-VERS.2006, FM1221E1, FM1221E1-VERS.2006, FM1221E2, FM1221E2-VERS.2006, FM1221E3, FM1221E3-VERS.2006, FM1221G1, FM1221G1-VERS.2006, FM1221G2, FM1221G2-VERS.2006, FM1221G3, FM1221G3-VERS.2006, FM2011E2-VERS.2006, FM2011E3-VERS.2006, FM2011G2-VERS.2006, FM2011G3-VERS.2006, FM2021E1, FM2021E2, FM2021E2-VERS.2006, FM2021E3, FM2021E3-VERS.2006, FM2021G1, FM2021G2, FM2021G2-VERS.2006, FM2021G3, FM2021G3-VERS.2006, FM611E1, FM611E1-VERS.2006, FM611E2, FM611E2-VERS.2006, FM611E3, FM611E3-VERS.2006... (Otros modelos se puede ver en la tienda web)		

			
1			
código	692864	referencia	3108741
descripción	cojinete giratorio con enclavamiento con perno pos. de montaje abajo derecha		

			
1			
código	692863	referencia	36E2660
descripción	cojinete giratorio con enclavamiento sin perno pos. de montaje abajo derecha		
Para modelos:	FC1011E, FC1011G, FC1221E, FC1221G, FC611E, FC611G, FM1011E1, FM1011E1-VERS.2006, FM1011E2, FM1011E2-VERS.2006, FM1011E3, FM1011E3-VERS.2006, FM1011G1, FM1011G1-VERS.2006, FM1011G2, FM1011G2-VERS.2006, FM1011G3, FM1011G3-VERS.2006, FM1221E1, FM1221E1-VERS.2006, FM1221E2, FM1221E2-VERS.2006, FM1221E3, FM1221E3-VERS.2006, FM1221G1, FM1221G1-VERS.2006, FM1221G2, FM1221G2-VERS.2006, FM1221G3, FM1221G3-VERS.2006, FM2011E2-VERS.2006, FM2011E3-VERS.2006, FM2011G2-VERS.2006, FM2011G3-VERS.2006, FM2021E1, FM2021E2, FM2021E2-VERS.2006, FM2021E3, FM2021E3-VERS.2006, FM2021G1, FM2021G2, FM2021G2-VERS.2006, FM2021G3, FM2021G3-VERS.2006, FM611E1, FM611E1-VERS.2006, FM611E2, FM611E2-VERS.2006, FM611E3, FM611E3-VERS.2006... (Otros modelos se puede ver en la tienda web)		

accesorios

otros

			
1			
código	690689	referencia	35X3460
descripción	anillo distnciador		
Para modelos:	40EV, 40EVP, 40PV, 40XPV		

			
1			
código	690691	referencia	36C2440
descripción	anillo distnciador		
Para modelos:	40EV, 40EVP, 40PV, 40XPV		

			
1			
código	690687	referencia	36D2880
descripción	arandela		
Para modelos:	40, 40B, 40CP, 40CPX, 40PL, 40X, SA87		

elementos extraíbles
guías telescópicas

universal

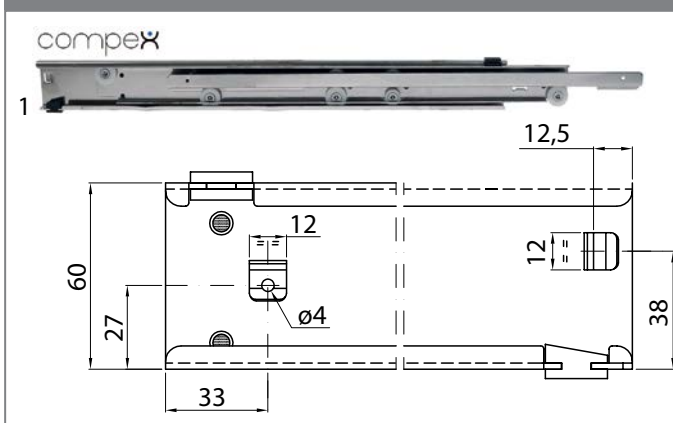

código	696714 ¹	referencia	36M8080 36M8090
descripción	guía telescópica L 550mm long.extracción 610mm longitud total 1160mm UE 1 par capacidad 50kg An 16mm H 60mm inox extension total		
Para modelos:	3G6SA, 3G6SA2, 3G6SA4, 4G6SB, 4G6SB2, 4G6SB4, 4G6SB6, 6BR15V, 6BR15VC, 6BR19V, 6BR19VC, 6EA11, 6EA11A, 6EA11M, 6EA13, 6EA13A, 6EA13M, 6EA2, 6EA2A, 6EA2M, 6EB11, 6EB11A, 6EB11M, 6EB13, 6EB13A, 6EB13M, 6EB2, 6EB22, 6EB22A, 6EB22M, 6EB2A, 6EB2M, 6EB4, 6EB4A, 6EB4M, 6EC11, 6EC11A, 6EC11M, 6EC13, 6EC13A, 6EC13M, 6EC2, 6EC22, 6EC22A, 6EC22M, 6EC2A, 6EC2M, 6EC4, 6EC4A, 6EC4M...(Otros modelos se puede ver en la tienda web)		
repuestos para	696714		
	código	690750	referencia —
tope para guía telescópica L 20mm plástico H 12mm P 9mm			

¹guía múltiple (60mm mas de longitud nominal)
Continúa en la página siguiente



repuestos para	696714			
	código	696333	referencia	—
	tope para guía telescópica L 20mm plástico H 15mm P 8mm			

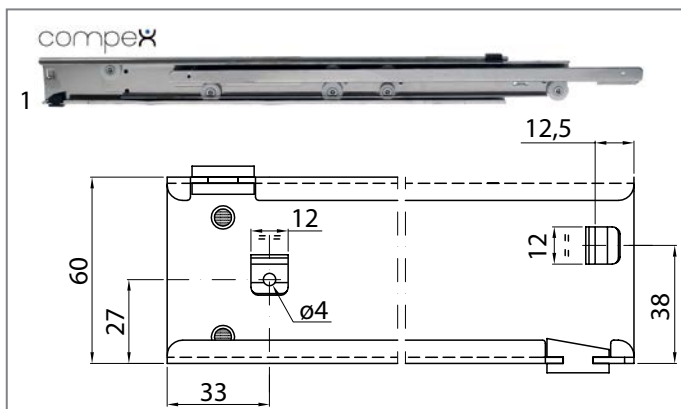

código	690744 ¹	referencia	36M5380 36M5390
---------------	---------------------	-------------------	--------------------

descripción guía telescópica L 600mm long.extracción 660mm longitud total 1260mm UE 1 par capacidad 45kg An 17mm H 60mm pos. de montaje derecho/izquierdo inox extension total

Para modelos: 6BEA11A, 6BEA11B, 6BEA11M, 6BEA11Z, 6BEA2A, 6BEA2B, 6BEA2M, 6BEA2Z, 6BEA3A, 6BEA3B, 6BEA3M, 6BEA3Z, 6BEB11A, 6BEB11B, 6BEB11M, 6BEB11Z, 6BEB22A, 6BEB22B, 6BEB22M, 6BEB22Z, 6BEB2A, 6BEB2B, 6BEB2M, 6BEB2Z, 6BEB3A, 6BEB3B, 6BEB3M, 6BEB3Z, 6BEB4A, 6BEB4B, 6BEB4M, 6BEB4Z, 6BEC11A, 6BEC11B, 6BEC11M, 6BEC11Z, 6BEC22A, 6BEC22B, 6BEC22M, 6BEC22Z, 6BEC2A, 6BEC2B, 6BEC2M, 6BEC2Z, 6BEC33A, 6BEC33B, 6BEC33M, 6BEC33Z, 6BEC3A, 6BEC3B...(Otros modelos se puede ver en la tienda web)

repuestos para	690744			
	código	690750	referencia	—
	tope para guía telescópica L 20mm plástico H 12mm P 9mm			

	código	696333	referencia	—
	tope para guía telescópica L 20mm plástico H 15mm P 8mm			

¹guía múltiple (60mm mas de longitud nominal)

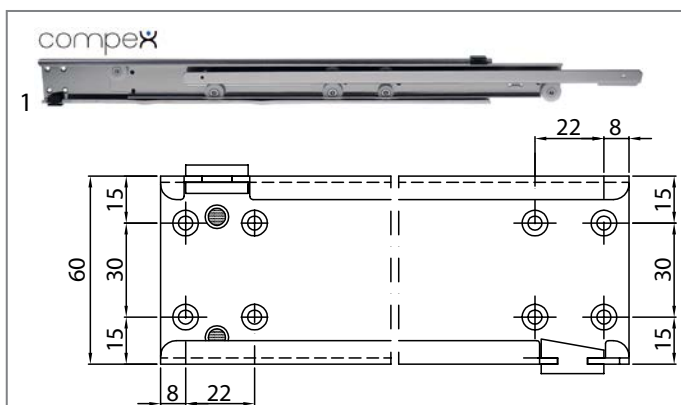

código	690752 ¹	referencia	36M2700 36M2710 36M4920 36M4940
---------------	---------------------	-------------------	--

descripción guía telescópica L 600mm long.extracción 660mm longitud total 1260mm UE 1 par capacidad 45kg H 60mm inox extension total

repuestos para	690752			
	código	690750	referencia	—
	tope para guía telescópica L 20mm plástico H 12mm P 9mm			

	código	696333	referencia	—
	tope para guía telescópica L 20mm plástico H 15mm P 8mm			

¹guía múltiple (60mm mas de longitud nominal)

específico del fabricante

1 	código	690771	referencia	30A2650 36M2650
	descripción	guía telescópica L 500mm long.extracción 400mm UE 1 pieza An 23mm pos. de montaje derecho		



1 	código	690770	referencia	30A2660 36M2660
	descripción	guía telescópica L 500mm long.extracción 400mm UE 1 pieza An 23mm pos. de montaje izquierdo		

ruedas de rodadura

ruedas de rodadura

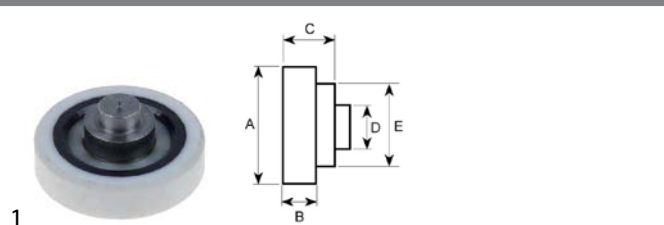

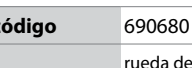
1 	código	690680	referencia	36G2810
	descripción	rueda de rodadura rodilloø 24mm A1 6mm anchura total 9mm A 24mm B 6mm C 9mm D 6mm E 10mm cerámica cojinete rodamiento de bolas		

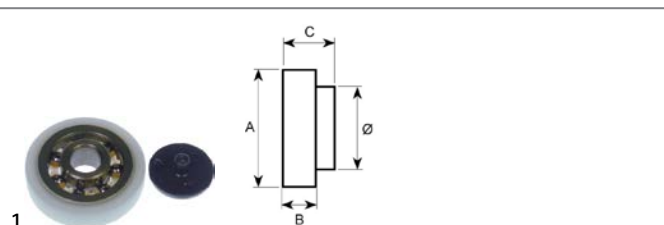

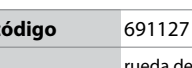
1 	código	691127	referencia	36F0440
	descripción	rueda de rodadura rodilloø 24mm A1 6mm anchura total 7.5mm A 24mm B 6mm C 7.5mm ø 10mm plástico superficie fricción plástico taladro ø 6mm		



código	691197	referencia	36G3940
descripción	rueda de rodadura rodilloø 30mm anchura total 10mm A 90mm B 10mm plástico		
Para modelos:	A12A1E, A12B1E, A12B2E, A12M1E, A12Z1E, A12Z2E, A14A1E, A14B1E, A14B2E, A14M1E, A14Z1E, A14Z2E, A16A1E, A16B1E, A16B2E, A16M1E, A16Z1E, A16Z2E, A18A1E, A18B1E, A18B2E, A18M1E, A18Z1E, A18Z2E, A20A1E, A20B1E, A20B2E, A20M1E, A20Z1E, A20Z2E, ACBM, ACBM218, ACPN, ACPN218, AJ12AE, AJ12ME, AJ14AE, AJ14ME, AJ16AE, AJ16ME, AJ18AE, AJ18ME, AJ20AE, AJ20ME, ANBM, ANBM218, ART1LD, ART1LDA, ART2LD, ART2SD... (Otros modelos se puede ver en la tienda web)		
accesorios para	691197		
		código	691126 referencia 36D4440
	cojinete H 11mm para rueda de rodadura		

accesorios



código	691126	referencia	36D4440
descripción	cojinete H 11mm para rueda de rodadura		
Para modelos:	A12A1E, A12B1E, A12B2E, A12M1E, A12Z1E, A12Z2E, A14A1E, A14B1E, A14B2E, A14M1E, A14Z1E, A14Z2E, A16A1E, A16B1E, A16B2E, A16M1E, A16Z1E, A16Z2E, A18A1E, A18B1E, A18B2E, A18M1E, A18Z1E, A18Z2E, A20A1E, A20B1E, A20B2E, A20M1E, A20Z1E, A20Z2E, ACBM, ACBM218, ACPN, ACPN218, AJ12AE, AJ12ME, AJ14AE, AJ14ME, AJ16AE, AJ16ME, AJ18AE, AJ18ME, AJ20AE, AJ20ME, ANBM, ANBM218, ART1LD, ART1LDA, ART2LD, ART2SD... (Otros modelos se puede ver en la tienda web)		



código	540699	referencia	3072720
descripción	grifo de salida An 35mm H 35mm rosca 3/4" H		
Para modelos:	6BM, 6CP, 6FR		

específico del fabricante

ANGELO PO



código	540683	referencia	36D4080
descripción	adaptador rosca		
Para modelos:	030BME, 030EBM, 030FE, 031BME, 031EBM		



código	540952	referencia	33D2840
descripción	grifo de salida L 84mm freidora manilla boquilla ø 30mm longitud boquilla 29mm rosca 3/4" H longitud de asidero 81mm		
Para modelos:	0M0BME, 0M0FR1E, 0M0FR1G, 1M0BME, 1M0CP1E, 1M0FR2E, 1M0FR2G		



código	540759	referencia	3111510 33D1760
descripción	grifo de salida sin asidero rosca 1" F		
Para modelos:	091FR1E, 091FR1EA, 091FR1ED, 091FR1G, 091FR1GD, 091FR1I, 091FR1IA, 091FR1ID, 091FR1ID-VERS.052012, 091FR1I-VERS.032012, 091FR7G, 091FR7G-VERS.052012, 0A1FR1E, 0A1FR1ED, 0A1FR1G, 0A1FR1GD, 0A1FR1GD-VERS.2004, 0A1FR1G-VERS.2004, 0B1FR1G, 0B1FR1GD, 0D1FR1E, 0D1FR1ED, 0D1FR1G, 0D1FR1GD, 0D1FR1GD-VERS.2004, 0D1FR1G-VERS.2004, 191FR2E, 191FR2ED, 191FR2G, 191FR2GD, 191FR2I, 191FR2ID, 191FR2ID-VERS.092012, 191FR2I-VERS.032012, 1A1FR2E, 1A1FR2ED, 1A1FR2G, 1A1FR2GD, 1A1FR2GD-VERS.2004, 1A1FR2G-VERS.2004, 1D1FR2ED, 1D1FR2G, 1D1FR2GD, 1D1FR2GD-VERS.2004, 1D1FR2G-VERS.2004, 70F1, 70F1B, 70FE1, 70FE1B, 71F2... (Otros modelos se puede ver en la tienda web)		
repuestos para	540759	código	504561 referencia 3151080
			junta tórica EPDM espesor 2.62mm int.ø 29.82mm UE 1 pzs

Continúa en la página siguiente

grifería para cocinas industriales



grifos de caño

universal





código	540685	referencia	33D0853
descripción	grifo de salida acero inoxidable acodado An 46mm H 40mm rosca 3/4" H		
Para modelos:	030FE1, 030FE1B		





accesorios para	540759			
	código	504561	referencia	3151080
	junta tórica EPDM espesor 2.62mm int.ø 29.82mm UE 1 pzs			
	código	540530	referencia	—
	manilla plástico blanco L 109mm			
	código	541529	referencia	—
	tubo vaciado L 110mm rosca			

	1		
código	540689	referencia	33D1770
descripción	grifo de salida sin asidero rosca 3/4" H		
Para modelos:	04WFR3ED, 06WFR3GD, 08WFR4ED, 091FE28, 091FE28B, 091FR3E, 091FR3ED, 091FR3G, 091FR3GD, 0A1FR3E, 0A1FR3ED, 0A1FR3G, 0A1FR3GD, 0D1FR3E, 0D1FR3ED, 0D1FR3G, 0D1FR3GD, 0G1FR3G, 0G1FR3GD, 0G1FR7G, 10WFR4GD, 191FR4E, 191FR4ED, 191FR4G, 191FR4GD, 1A1FR4E, 1A1FR4ED, 1A1FR4G, 1A1FR4GD, 1D1FR4E, 1D1FR4ED, 1D1FR4G, 1D1FR4GD, 1G1FR4G, 1G1FR4GD, 1G1FR8G, 30F1, 30F1B, 30FES2, 30FES2B, 30FS2, 30FS2B, 6043840, 6043970, 70FES2, 70FES2B, 90F110B, 91F210, 91F210B		

accesorios para	540689			
	código	514217	referencia	—
	manilla para grifo de salida			
	código	532487	referencia	3150690
	junta tórica Viton espesor 2.62mm int.ø 25.07mm UE 1 pzs			
	código	541530	referencia	3268961 3AZ0090
	tubo vaciado rosca			

	1		
código	540681	referencia	36D4070
descripción	tubo vaciado L 97mm rosca 3/4" M		
Para modelos:	030BME, 030FE, 031BME		

	1		
código	514153	referencia	3AZ0100
descripción	tubo vaciado rosca		
Para modelos:	091FR1E, 091FR1EA, 091FR1ED, 091FR1G, 091FR1GD, 091FR1I, 091FR1IA, 091FR1ID, 091FR1I-VERS.032012, 091FR7G, 091FR7G-VERS.052012, 0A1FR1E, 0A1FR1ED, 0A1FR1G, 0A1FR1GD, 0A1FR1GD-VERS.2004, 0A1FR1G-VERS.2004, 0B1FR1G, 0B1FR1GD, 0D1FR1E, 0D1FR1ED, 0D1FR1G, 0D1FR1GD, 0D1FR1GD-VERS.2004, 0D1FR1G-VERS.2004, 191FR2E, 191FR2ED, 191FR2G, 191FR2GD, 191FR2I, 191FR2ID, 191FR2I-VERS.032012, 1A1FR2E, 1A1FR2ED, 1A1FR2G, 1A1FR2GD, 1A1FR2GD-VERS.2004, 1A1FR2G-VERS.2004, 1D1FR2ED, 1D1FR2G, 1D1FR2GD, 1D1FR2GD-VERS.2004, 1D1FR2G-VERS.2004, 70F1, 70F1B, 70FE1, 70FE1B, 71F2, 71F2B, 71FE2...(Otros modelos se puede ver en la tienda web)		

	1		
código	541530	referencia	3268961 3AZ0090
descripción	tubo vaciado rosca		
Para modelos:	04WFR3ED, 06WFR3GD, 08WFR4ED, 091FE28, 091FE28B, 091FR3E, 091FR3ED, 091FR3G, 091FR3GD, 0A1FR3E, 0A1FR3ED, 0A1FR3G, 0A1FR3GD, 0D1FR3E, 0D1FR3ED, 0D1FR3G, 0D1FR3GD, 0G1FR3G, 0G1FR3GD, 0G1FR7G, 10WFR4GD, 191FR4E, 191FR4ED, 191FR4G, 191FR4GD, 1A1FR4E, 1A1FR4ED, 1A1FR4G, 1A1FR4GD, 1D1FR4E, 1D1FR4ED, 1D1FR4G, 1D1FR4GD, 1G1FR4G, 1G1FR4GD, 1G1FR8G, 30F1, 30F1B, 30FES2, 30FES2B, 30FS2, 30FS2B, 90F110B, 91F210, 91F210B		

	1		
código	540684	referencia	33Q5020
descripción	tubo vaciado rosca longitud total 54mm soporte de eje ø 22mm		
Para modelos:	030BME, 030EBM, 030FE, 031BME, 031EBM		

	1		
código	540730	referencia	33D0170
descripción	válvula de bola empalme 3/4" H - 3/4" H DN20 longitud 70mm con manilla de palanca longitud de asidero 95mm		
Para modelos:	030BME, 030EBM, 030FE, 031BME, 031EBM, 070BM, 070BME, 071BM, 071BME, 090BM, 090BME, 091BM, 091BME, 30F, 30FES, 30FS, 70FES		

aireadores y purgadores

	1		
código	540827	referencia	33G0170
descripción	aireador/purgador rosca 3/4" M cromado L 45mm ø 36mm		
Para modelos:	31PI6, 31PIE6, 71PI10, 71PI10A, 71PIE15, 71PIE15A, 71PV15, 71PV15A, 91PI10, 91PI10A, 91PIE15, 91PIE15A, BPV2, MCF40V, PV200, PV200A, PV300, PV300A		

	1		
código	540825	referencia	33G0650
descripción	aireador/purgador rosca 3/8" M EC 24 cromado L 37mm		
Para modelos:	191PI1G, 191PI1GA, 191PI2E, 191PI2EA, 191PI2G, 191PI2GA, 191PI2V, 191PI2VA, 1A1PI1G, 1A1PI1GA, 1A1PI2E, 1A1PI2EA, 1A1PI2G, 1A1PI2GA, 1A1PI2V, 1A1PI2VA, 1D1PI1G, 1D1PI1GA, 1D1PI2E, 1D1PI2EA, 1D1PI2G, 1D1PI2GA, 1D1PI2V, 1D1PI2VA, 2A1PI3G, 2D1PI3G, PV200, PV200A, PV300, PV300A		

válvulas de vapor



1

código	520000	referencia	33G0030 33G0031
descripción	válvula de vapor acodado empalme 1 1/4" F longitud 52mm H 190mm latón		
Para modelos:	191PI2V, 191PI2VA, 1A1PI2V, 1A1PI2VA, 1D1PI2V, 1D1PI2VA, 71PV15, 71PV15A, PV200, PV200A, PV300, PV300A		
repuestos para	520000		
	código	541566	referencia —
montura para grifo de vapor 1 1/4" eje 9x9mm			
	código	541567	referencia —
manilla en forma de estrella eje 9x9mm ø 74mm L 24mm negro plástico			

bisagras de tapa

ANGELO PO



1

código	692706	referencia	36H0260
descripción	árbol L 445mm ø 12mm para tapa		
Para modelos:	10CP1EA, 10CP1GA, 10CP1IA, 12CP1EA, 12CP1GA, 12CP1IA, 18CP2EA, 18CP2GA, 18CP2IA, 191BR1E, 191BR1G, 191BR1GA, 191BR2E, 191BR2EA, 191BR2G, 191BR2GA, 1A1BR1E, 1A1BR1G, 1A1BR1GA, 1A1BR2E, 1A1BR2EA, 1A1BR2G, 1A1BR2GA, 1D1BR1E, 1D1BR1G, 1D1BR1GA, 1D1BR2E, 1D1BR2EA, 1D1BR2G, 1D1BR2GA, 291BR1E, 291BR1G, 291BR1GA, 291BR2E, 291BR2EA, 291BR2G, 291BR2GA, 2A1BR1E, 2A1BR1G, 2A1BR1GA, 2A1BR2E, 2A1BR2EA, 2A1BR2G, 2A1BR2GA, 2D1BR1E, 2D1BR1G, 2D1BR1GA, 2D1BR2E, 2D1BR2EA, 2D1BR2G... (Otros modelos se puede ver en la tienda web)		



1

código	692705	referencia	36C2590
descripción	soporte pos. de montaje derecho distancia de sujeción 45mm para tapa		
Para modelos:	10CP1EA, 10CP1GA, 12CP1EA, 12CP1GA, 18CP2EA, 18CP2GA, 191BR1E, 191BR1G, 191BR1GA, 191BR2E, 191BR2EA, 191BR2G, 191BR2GA, 191PD1G, 191PD2G, 191PI1G, 191PI1GA, 191PI2E, 191PI2EA, 191PI2G, 191PI2GA, 191PI2V, 191PI2VA, 1A1BR1E, 1A1BR1G, 1A1BR1GA, 1A1BR2E, 1A1BR2EA, 1A1BR2G, 1A1BR2GA, 1A1PD1G, 1A1PD2G, 1A1PI1G, 1A1PI1GA, 1A1PI2E, 1A1PI2EA, 1A1PI2G, 1A1PI2GA, 1A1PI2V, 1A1PI2VA, 1D1BR1E, 1D1BR1G, 1D1BR1GA, 1D1BR2E, 1D1BR2EA, 1D1BR2G, 1D1BR2GA, 1D1PD1G, 1D1PD2G, 1D1PI1G... (Otros modelos se puede ver en la tienda web)		



1

código	692704	referencia	36C2600
descripción	soporte pos. de montaje izquierdo distancia de sujeción 45mm para tapa		
Para modelos:	10CP1EA, 10CP1GA, 12CP1EA, 12CP1GA, 18CP2EA, 18CP2GA, 191BR1E, 191BR1G, 191BR1GA, 191BR2E, 191BR2EA, 191BR2G, 191BR2GA, 191PD1G, 191PD2G, 191PI1G, 191PI1GA, 191PI2E, 191PI2EA, 191PI2G, 191PI2GA, 191PI2V, 191PI2VA, 1A1BR1E, 1A1BR1G, 1A1BR1GA, 1A1BR2E, 1A1BR2EA, 1A1BR2G, 1A1BR2GA, 1A1PD1G, 1A1PD2G, 1A1PI1G, 1A1PI1GA, 1A1PI2E, 1A1PI2EA, 1A1PI2G, 1A1PI2GA, 1A1PI2V, 1A1PI2VA, 1D1BR1E, 1D1BR1G, 1D1BR1GA, 1D1BR2E, 1D1BR2EA, 1D1BR2G, 1D1BR2GA, 1D1PD1G, 1D1PD2G, 1D1PI1G... (Otros modelos se puede ver en la tienda web)		

otros

piezas de repuesto



1

código	700683	referencia	36G2680
descripción	perno para resorte de torsión		
Para modelos:	12CP1GA, 12CP1IA, 191BR1E, 191BR1G, 191BR1GA, 191BR2E, 191BR2EA, 191BR2G, 191BR2GA, 191PD1G, 191PD2G, 191PI1G, 191PI1GA, 191PI2E, 191PI2EA, 191PI2G, 191PI2GA, 191PI2V, 191PI2VA, 1A1BR1E, 1A1BR1G, 1A1BR1GA, 1A1BR2E, 1A1BR2EA, 1A1BR2G, 1A1BR2GA, 1A1PD1G, 1A1PD2G, 1A1PI1G, 1A1PI1GA, 1A1PI2E, 1A1PI2EA, 1A1PI2G, 1A1PI2GA, 1A1PI2V, 1A1PI2VA, 1D1BR1E, 1D1BR1G, 1D1BR1GA, 1D1BR2E, 1D1BR2EA, 1D1BR2G, 1D1BR2GA, 1D1PD1G, 1D1PD2G, 1D1PI1G, 1D1PI1GA, 1D1PI2E, 1D1PI2EA, 1D1PI2G... (Otros modelos se puede ver en la tienda web)		

grifos de vaciado

latón

grifos de vaciado



1

código	540131	referencia	33D0080
descripción	grifo de vaciado 1 1/4" F latón cromado		
repuestos para	540131		
	código	540213	referencia —
manilla int.ø 5mm L 117mm			
	código	540461	referencia —
arandela distanciadora para grifo de vaciado			

Continúa en la página siguiente





repuestos para	540131			
	código	540464	referencia	—
				tuerca para grifo de vaciado rosca 1 1/2"



código	540275	referencia	33D0600
descripción	grifo de vaciado 2" H con tuerca de racor A 90mm B 151mm B1 80mm latón cromado		
Para modelos:	31PD6, 31PI6, 31PIE6, 71PD10, 71PD15, 71PI10, 71PI10A, 71PIE15, 71PIE15A, 71PV15, 71PV15A, 91PI10, 91PI10A, 91PIE15, 91PIE15A		

repuestos para	540275			
	código	540214	referencia	—
				manilla int.ø 6mm L 145mm

accesorios para	540275			
	código	529484	referencia	—
				junta plana fibra ø ext. 58mm int.ø 50mm espesor 2mm UE 1 pzs

	código	542448	referencia	—
				junta silicona 60x49x2 para grifo de vaciado 2"





código	540134	referencia	33D2291
descripción	grifo de vaciado 2" H fijo 3,0 A 115mm B1 90mm B2 165mm latón cromado		

Para modelos:	191CP1GA, 191PD1G, 191PD2G, 191PI1G, 191PI1GA, 191PI2E, 191PI2EA, 191PI2G, 191PI2GA, 191PI2V, 191PI2VA, 1A1CP1GA, 1A1PD1G, 1A1PD2G, 1A1PI1G, 1A1PI1GA, 1A1PI2E, 1A1PI2EA, 1A1PI2G, 1A1PI2GA, 1A1PI2V, 1A1PI2VA, 1D1CP1GA, 1D1PD1G, 1D1PD2G, 1D1PI1G, 1D1PI1GA, 1D1PI2E, 1D1PI2EA, 1D1PI2G, 1D1PI2GA, 1D1PI2V, 1D1PI2VA, 1G1PD1G, 1G1PI1E, 1G1PI1G, 291PD3G, 291PI3E, 291PI3G, 2A1PD3G, 2A1PI3E, 2A1PI3G, 2D1PI3G, 31PD6, 31PI6, 31PIE6, 71PD10, 71PD15, 71PI10, 71PI10A... (Otros modelos se puede ver en la tienda web)		
----------------------	--	--	--

repuestos para	540134			
	código	540214	referencia	—
				manilla int.ø 6mm L 145mm

	código	540462	referencia	—
				anillo para grifo de vaciado

	código	540465	referencia	—
				tuerca para grifo de vaciado rosca 2 3/4"

accesorios para	540134			
	código	529484	referencia	—
				junta plana fibra ø ext. 58mm int.ø 50mm espesor 2mm UE 1 pzs



código	540267	referencia	33D2290
descripción	grifo de vaciado empalme con tuerca de racor rosca 2"		

Para modelos:	191CP1GA, 191PD1G, 191PD2G, 191PI1G, 191PI1GA, 191PI2E, 191PI2EA, 191PI2G, 191PI2GA, 191PI2V, 191PI2VA, 1A1CP1GA, 1A1PD1G, 1A1PD2G, 1A1PI1G, 1A1PI1GA, 1A1PI2E, 1A1PI2EA, 1A1PI2G, 1A1PI2GA, 1A1PI2V, 1A1PI2VA, 1D1CP1GA, 1D1PD1G, 1D1PD2G, 1D1PI1G, 1D1PI1GA, 1D1PI2E, 1D1PI2EA, 1D1PI2G, 1D1PI2GA, 1D1PI2V, 1D1PI2VA, 1G1PD1G, 1G1PI1E, 1G1PI1G, 291PD3G, 291PI3E, 291PI3G, 2A1PD3G, 2A1PI3E, 2A1PI3G, 2D1PI3G, 31PD6, 31PI6, 31PIE6, 71PD10, 71PD15, 71PI10, 71PI10A... (Otros modelos se puede ver en la tienda web)		
----------------------	--	--	--

repuestos para	540267			
	código	505517	referencia	—
				junta tórica EPDM espesor 5.34mm int.ø 53.34mm UE 1 pzs

	código	540214	referencia	—
				manilla int.ø 6mm L 145mm

accesorios



código	541485	referencia	35Z5100
descripción	empalme enroscable para grifo de vaciado rosca 2" L 167mm		
Para modelos:	71PD10, 71PD15, 71PI10, 71PI10A, 71PIE15, 71PIE15A, 71PV15, 71PV15A, 91PI10, 91PI10A, 91PIE15, 91PIE15A		

grifos de prueba

grifos de prueba

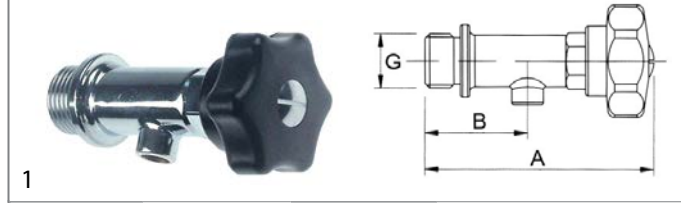

código	540818	referencia	3028010
descripción	grifo de prueba rosca 1/2" M An 88mm B1 38mm		

Para modelos:	191PI1G, 191PI1GA, 191PI2E, 191PI2EA, 191PI2G, 191PI2GA, 1A1PI1G, 1A1PI1GA, 1A1PI2E, 1A1PI2EA, 1D1PI1G, 1D1PI1GA, 1D1PI2E, 1D1PI2EA, 1G1PI1E, 1G1PI1G, 31PI6, 31PIE6, 71PI10, 71PI10A, 71PIE15, 71PIE15A, 91PI10, 91PI10A, 91PIE15, 91PIE15A		
----------------------	--	--	--

accesorios



1

código	515105	referencia	37M0590
descripción	roseta		
Para modelos:	1A1PI1G, 1A1PI1GA, 1A1PI2E, 1A1PI2EA, 1D1PI1G, 1D1PI1GA, 1D1PI2E, 1D1PI2EA, 1G1PI1E, 1G1PI1G, 3PI6, 3PIE6, 71PI10, 71PI10A, 71PIE15, 71PIE15A, 91PI10, 91PI10A, 91PIE15, 91PIE15A		

grifos de seguridad

grifos de seguridad



1

código	514275	referencia	3006310
descripción	grifo de seguridad rosca 3/4" 0.45bar con manómetro y aireador/purgador 3.3kg H 200mm An 150mm		
Para modelos:	191PI1G, 191PI1GA, 191PI2E, 191PI2EA, 191PI2G, 191PI2GA, 191PI2V, 191PI2VA, 1A1PI1G, 1A1PI1GA, 1A1PI2E, 1A1PI2EA, 1A1PI2G, 1A1PI2GA, 1A1PI2V, 1A1PI2VA, 1D1PI1G, 1D1PI1GA, 1D1PI2E, 1D1PI2EA, 1D1PI2G, 1D1PI2GA, 1D1PI2V, 1D1PI2VA, 1G1PI1E, 1G1PI1G, 291PI3E, 291PI3G, 2A1PI3G, 2D1PI3G, PV200, PV200A, PV300, PV300A		
repuestos para	514275		
	código	514094	referencia —
	pieza angular rosca 3/8"		
	código	514276	referencia —
	grifo de seguridad rosca 3/4" 0.45bar H 165mm ø 65mm		
	código	540825	referencia 33G0650
	aireador/purgador rosca 3/8" M EC 24 cromado L 37mm		
	código	540828	referencia —
	sifón manómetro rosca 3/8"		
	código	541579	referencia —
	manómetro ø 52mm margen de presión 0 a 1 bar empalme marca 0.5 rosca 1/4"		

accesorios



1

código	540633	referencia	33G0560
descripción	soporte para grifería rosca 1/2" H		
Para modelos:	1A1PI1G, 1A1PI1GA, 1A1PI2E, 1A1PI2EA, 1A1PI2V, 1A1PI2VA, 1D1PI1G, 1D1PI1GA, 1D1PI2E, 1D1PI2EA, 1D1PI2V, 1D1PI2VA		

1

código	540821	referencia	33G0130
descripción	soporte para grifería rosca 1/4"		
Para modelos:	3PI6, 3PIE6, 71PI10, 71PI10A, 71PIE15, 71PIE15A, 71PV15, 71PV15A, 91PI10, 91PI10A, 91PIE15, 91PIE15A		

1

código	540830	referencia	33G0160
descripción	grifo de manómetro H 1/4" M 1/4"		

1

código	541501	referencia	33Q4650
descripción	reducción para grifo de seguridad H 1/4" M 3/4"		

válvulas de seguridad



1

código	540722	referencia	33G0150
descripción	válvula de seguridad con salida para tapa		
Para modelos:	191PI1GA, 191PI2EA, 191PI2GA, 191PI2VA, 1A1PI1GA, 1A1PI2EA, 1A1PI2GA, 1A1PI2VA, 1D1PI1GA, 1D1PI2E, 1D1PI2EA, 1D1PI2GA, 1D1PI2VA, 71PI10A, 71PIE15A, 71PV15A, 91PI10A, 91PIE15A, PV200A, PV300A		



1

código	540721	referencia	33G0200
descripción	válvula de seguridad presión de intervención 0.5bar M88 rosca 1¼"		
Para modelos:	31PI6, 31PIE6, 71PI10, 71PI10A, 71PIE15, 71PIE15A, 71PV15, 71PV15A, 91PI10, 91PI10A, 91PIE15, 91PIE15A, PV200, PV200A, PV300, PV300A		
accesorios para	540721		
	código	541501	referencia 33Q4650
	reducción para grifo de seguridad H 1¼" M 3/4"		

piezas sueltas



1

código	701091	referencia	6000150
descripción	pie de aparato H 125mm EC 55 1½" H		

filtros

filtros de aire



1

código	750164	referencia	36D5560
descripción	filtro de aire L 240mm An 190mm H 5mm		
Para modelos:	AL1433, AL1433V, AL1437, AL1437V, AL1633, AL1633V, AL2033, AL2033V, AL2533, AL2533V, PE1633, PE1633V, PE2033, PE2033V, PM1633, PM1633V, PM2033, PM2033V, PZ1633A, PZ1633B, PZ2033A, PZ2033B, PZ2533A, PZ2533B, SP120, SP120BN, SP120NN, SP135, SP135BN, SP135CP, SP135NN, SP55, SP65, SP65NN		

con placa de sujeción



1

código	701379	referencia	3137690 36C5600
descripción	pie de aparato tubo ø 64mm dimensiones de la placa 80-100mm dist. del agujero 60-80mm H 105-155mm inox medida 2 1/2" UE 1 pzs		
Para modelos:	3G6SA, 3G6SA2, 3G6SA4, 4G6SB, 4G6SB2, 4G6SB4, 4G6SB6, 6SA, 6SA2, 6SA2M, 6SAM, 6SB, 6SB2, 6SB2M, 6SBM, AF1B, AF1B-OPR01, AF1N, AF1N-OPR01, AF2B, AF2B-OPR01, AF2N, AF2N-OPR01, AGL6B, B1101S, BF101L, BF101S, C12Q1M, C12Q2M, CX120, CX120B, CX120NN, CX130, CX130B, CX130NN, CX140, CX140B, CX140BN, CX140BR, CX140CP, CX140NN, CX140PV, CX140R, CX150, CX150B, CX150BN, CX150BR, CX150CP, CX150NN, CX150PV...(Otros modelos se puede ver en la tienda web)		

pies para aparatos y tapas terminales

pies para aparatos

con fijación atornillada



1

código	701638	referencia	3313390
descripción	pie de aparato tubo ø 63.5mm rosca M10 F H 145-230mm inox UE 1 pzs		



1

código	700709	referencia	36C5550
descripción	pie de aparato tubo ø 64mm dimensiones de la placa 80x100mm dist. del agujero 60x80mm H 115-170mm inox medida 2 2/3" UE 1 pzs		
Para modelos:	3G6SA, 3G6SA2, 3G6SA4, 4G6SB, 4G6SB2, 4G6SB4, 4G6SB6, 6MRA, 6MRA2, 6MRA2A, 6MRA2M, 6MRA2Z, 6MRA4, 6MRA4A, 6MRA4M, 6MRA4Z, 6MRAA, 6MRAA, 6MRAZ, 6MRB, 6MRB11, 6MRB11A, 6MRB11M, 6MRB11Z, 6MRB2, 6MRB2A, 6MRB2M, 6MRB2Z, 6MRB4, 6MRB4A, 6MRB4M, 6MRB4Z, 6MRB6, 6MRB6A, 6MRB6M, 6MRB6Z, 6MRBA, 6MRBM, 6MRBZ, 6MRC, 6MRC11, 6MRC11A, 6MRC11M, 6MRC11Z, 6MRC2, 6MRC2A, 6MRC2M, 6MRC2Z, 6MRC4, 6MRC4A...(Otros modelos se puede ver en la tienda web)		

			
1			
código	701378	referencia	3145280 36C4540
descripción	pie de aparato tubo ø 64mm dimensiones de la placa 80x100mm dist. del agujero 60x80mm H 150-200mm inox medida 2 1/2" UE 1 pzs		
Para modelos:	6BR15V, 6BR15VC, 6BR19V, 6BR19VC, 6EA, 6EA11, 6EA11A, 6EA11M, 6EA13, 6EA13A, 6EA13M, 6EA2, 6EA2A, 6EA2M, 6EAA, 6EAB, 6EABA, 6EABM, 6EAM, 6EB, 6EB11, 6EB11A, 6EB11M, 6EB13, 6EB13A, 6EB13M, 6EB2, 6EB22, 6EB22A, 6EB22M, 6EB2A, 6EB2M, 6EB4, 6EB4A, 6EB4M, 6EBA, 6EBB, 6EBBA, 6EBBM, 6EBM, 6EC, 6EC11, 6EC11A, 6EC11M, 6EC13, 6EC13A, 6EC13M, 6EC2, 6EC22, 6EC22A...(Otros modelos se puede ver en la tienda web)		



			
1			
código	700708	referencia	36C4540 36C4540 old
descripción	pie de aparato tubo ø 64mm dimensiones de la placa 90x90mm dist. del agujero 70x70mm H 140-195mm inox medida 2 1/2" UE 1 pzs		

piezas sueltas

			
1			
código	701091	referencia	6000150
descripción	pie de aparato H 125mm EC 55 1 1/2" H		

			
1			
código	701090	referencia	36D4000
descripción	pie de aparato tubo ø 51mm dimensiones de la placamm dist. del agujeromm H 145mm plástico medida 2" M UE 1 pzs		
Para modelos:	30CPS, 30CPSE, 30F, 30F1, 30F1B, 30FES, 30FES2, 30FES2B, 30FS, 30FS2, 30FS2B, 31, 31GE, 31PD6, 31PI6, 31PIE6, 31R, 31RE, 31TC, 31TCE, 31TP, 32, 32TC, 32TCE, 32TP, 32TPV, 32V, 40, 40B, 40CP, 40CPX, 40EV, 40EVP, 40PV, 40X, 40XPV		

otros			
			
1			
código	691162	referencia	36D0160
descripción	pie de aparato H 25mm EC 46 plástico		

			
1			
código	691161	referencia	36D0150
descripción	pie de aparato H 41mm EC 56 parte inferior plástico		
repuestos para	691161		
	código	694485	referencia —
	plaqueta para cierre cámara frigorífica Exit ø 78mm		

pies enroscables

			
1			
código	695601	referencia	3095690
descripción	pie de aparato rosca M17 rosca L 23mm ø 24mm H 11mm plástico EC 24 UE 1 pzs		

			
1			
código	697815	referencia	36D4430
descripción	pie de aparato rosca M8 rosca L 10mm ø 48mm H 47mm goma UE 1 pzs		

			
1			
código	697770	referencia	36D5690
descripción	pie de aparato rosca M8 rosca L 12mm ø 47mm H 35mm UE 1 pzs		
Para modelos:	FCV3EM, FCV4E, FCV4EDS, FCV4EM, FM423E1, FM423E2, FMS, FMSX		



			
1			
código	691122	referencia	36E0010
descripción	pie de aparato rosca M8 rosca L 24mm ø 38mm H 13mm UE 1 pzs		
Para modelos:	6CP, 6FA, 6FA1, 6FR, 6FTL, 6FTR, 6PC, 6VTIM, 6VTIMM, 6VTIW, 6VTIWM, 6VTR, 6VTR2, F60P, F60PR, F60T, L45		

cestos

cestos para freidoras

ANGELO PO

			
1			
código	970775	referencia	55AL942 C3830AD
descripción	cesto de freidora B1 300mm L1 365mm H1 120mm		

			
1			
código	970547	referencia	3007210 3007220
descripción	cesto de freidora L1 280mm B1 225mm H1 115mm		
Para modelos:	04WFR3ED, 06WFR3GD, 08WFR4ED, 091FR3E, 091FR3ED, 091FR3G, 091FR3GD, 0A1FR3E, 0A1FR3ED, 0A1FR3G, 0A1FR3GD, 0D1FR3E, 0D1FR3ED, 0D1FR3G, 0D1FR3GD, 0G0FR3E, 0G0FR3ED, 0G1FR3G, 0G1FR3GD, 0G1FR7G, 10WFR4GD, 191FR4E, 191FR4ED, 191FR4G, 191FR4GD, 1A1FR4E, 1A1FR4ED, 1A1FR4G, 1A1FR4GD, 1D1FR4E, 1D1FR4ED, 1D1FR4G, 1D1FR4GD, 1G0FR4E, 1G1FR4G, 1G1FR4GD, 1G1FR8G, 6043840, 6043970		

			
1			
código	970175	referencia	36A2640
descripción	cesto de freidora L1 288mm B1 190mm H1 115mm L2 570mm H2 135mm H3 185mm acero cromado		
Para modelos:	030FE, 30F, 30FES, 30FS, 70FES		

			
1			
código	970338	referencia	36A3481
descripción	cesto de freidora L1 290mm B1 190mm H1 115mm L2 520mm H2 210mm H3 260mm acero cromado plástico/goma con soporte		
Para modelos:	030FE1, 030FE1B, 091FE28, 091FE28B, 30F1, 30F1B, 30FES2, 30FES2B, 30FS2, 30FS2B, 70FES2, 70FES2B, 90F110B, 91F210, 91F210B		

			
1			
código	970551	referencia	36A5350
descripción	cesto de freidora L1 305mm B1 225mm H1 115mm		

			
1			
código	970172	referencia	36A1300
descripción	cesto de freidora L1 315mm B1 210mm H1 120mm L2 495mm H2 170mm acero cromado		

			
1			
código	970174	referencia	36A2020
descripción	cesto de freidora L1 368mm B1 150mm H1 120mm L2 700mm H2 140mm H3 200mm acero cromado		
Para modelos:	70F, 70FE, 71F, 71FE		

			
1			
código	970339	referencia	36A3491
descripción	cesto de freidora L1 368mm B1 150mm H1 120mm L2 700mm H2 210mm H3 250mm acero cromado		
Para modelos:	70F1, 70F1B, 70FE1, 70FE1B, 71F2, 71F2B, 71FE2, 71FE2B, 91F223B		



1

código	970340	referencia	36A2340
descripción	cesto de freidora L1 370mm B1 150mm H1 120mm acero cromado		
Para modelos:	091FR1E, 091FR1ED, 091FR1G, 091FR1GD, 091FR1I, 091FR1ID, 091FR1ID-VERS.052012, 091FR1I-VERS.032012, 0A1FR1E, 0A1FR1ED, 0A1FR1G, 0A1FR1GD, 0A1FR1GD-VERS.2004, 0A1FR1G-VERS.2004, 0B1FR1G, 0B1FR1GD, 0D1FR1E, 0D1FR1ED, 0D1FR1G, 0D1FR1GD, 0D1FR1GD-VERS.2004, 0D1FR1G-VERS.2004, 191FR2E, 191FR2ED, 191FR2G, 191FR2GD, 191FR2I, 191FR2ID, 191FR2ID-VERS.092012, 191FR2I-VERS.032012, 1A1FR2E, 1A1FR2ED, 1A1FR2G, 1A1FR2GD, 1A1FR2GD-VERS.2004, 1A1FR2G-VERS.2004, 1D1FR2ED, 1D1FR2G, 1D1FR2GD, 1D1FR2GD-VERS.2004, 1D1FR2G-VERS.2004		



1

código	970173	referencia	36A0901
descripción	cesto de freidora L1 400mm B1 230mm H1 130mm L2 185mm H2 165mm H3 180mm		

cestas para pasta

ANGELO PO

ANGELO PO



1

código	970952	referencia	55AG018 C3023
descripción	cesta para pasta H1 200mm B1 230mm L1 306mm L2 480mm H2 250mm H3 310mm inox longitud del soporte 165mm		



1

código	970678	referencia	C4627
descripción	cesta para pasta H1 200mm B1 270mm L1 460mm		



1

código	970777	referencia	55AG028 KCP40G
descripción	cesta para pasta juego 4 piezas L1 265mm H1 200mm B1 115mm		



1

código	970563	referencia	3012120 C1011
descripción	cesta para pasta L1 110mm B1 100mm H1 150mm medida GN 1/8 acero inoxidable		



1

código	970565	referencia	3012140
descripción	cesta para pasta L1 280mm B1 300mm H1 150mm medida GN 3/4 acero inoxidable		



1

código	970337	referencia	36A2582
descripción	cesta para pasta L1 295mm B1 100mm H1 150mm medida GN 2/8 L2 470mm H2 230mm H3 310mm acero inoxidable		
Para modelos:	30CPS, 30CPSE, 70CP, 70CPE, 71CP, 71CP2, 90CP, 90CPE, 91CP		

 <p>1</p>			
código	970564	referencia	3012130 51AL961 C2028
descripción	cesta para pasta L1 295mm B1 180mm H1 150mm medida GN 1/2 acero inoxidable		

 <p>1</p>			
código	970548	referencia	3240680 C0930
descripción	cesta para pasta L1 305mm B1 95mm H1 205mm medida GN 2/8 H3 320mm acero inoxidable		

accesorios

 <p>1</p>			
código	692119	referencia	36A4631
descripción	rejilla L 500mm An 296mm H 83mm para cocedora de pasta		
Para modelos:	06WCP1GM, 08WCP1GM, 091CP1G, 0A1CP1G, 0B1CP1G, 0D1CP1G, 191CP2G, 1A1CP2G, 1D1CP2G, 1G1CP1G, 1G1CP1G-VERS.2004		

tamices para empanar

 <p>1</p>			
código	970553	referencia	36A2591
descripción	tamiz para empanar L 340mm An 330mm H mando 185mm acero inoxidable apto para cocedora de pasta		
Para modelos:	70CP, 71CP2, 90CP		

 <p>1</p>			
código	970554	referencia	36A2270
descripción	tamiz para empanar L 500mm An 295mm H 135mm		
Para modelos:	0A1CP1E, 0A1CP1G, 0D1CP1E, 0D1CP1G, 1A1CP2G, 1D1CP2G		

 <p>1</p>			
código	970573	referencia	36A2301
descripción	tamiz para empanar L 650mm An 340mm H asa 175mm acero inoxidable apto para cocedora de pasta		
Para modelos:	71CP, 91CP		

 <p>1</p>			
código	970560	referencia	3006800
descripción	tamiz para empanar L 335mm An 235mm apto para freidora		
Para modelos:	091FR3E, 091FR3ED, 0A1FR3E, 0A1FR3ED, 0D1FR3E, 0D1FR3ED, 0G0FR3E, 0G0FR3ED, 0G0FR5G, 191FR4E, 191FR4ED, 1A1FR4E, 1A1FR4ED, 1D1FR4E, 1D1FR4ED, 1G0FR4E, 1G0FR6G, 6043840, 6043970, 6FR		

 <p>1</p>			
código	970552	referencia	36A2320
descripción	tamiz para empanar L 430mm An 310mm H 190mm apto para freidora		
Para modelos:	091FR1E, 091FR1ED, 091FR1G, 091FR1GD, 091FR1I, 091FR1ID, 091FR1ID-VERS.052012, 091FR1I-VERS.032012, 0A1FR1E, 0A1FR1ED, 0A1FR1G, 0A1FR1GD, 0A1FR1GD-VERS.2004, 0A1FR1G-VERS.2004, 0B1FR1G, 0B1FR1GD, 0D1FR1E, 0D1FR1ED, 0D1FR1G, 0D1FR1GD, 0D1FR1GD-VERS.2004, 0D1FR1G-VERS.2004, 191FR2E, 191FR2ED, 191FR2G, 191FR2GD, 191FR2I, 191FR2ID, 191FR2ID-VERS.092012, 191FR2I-VERS.032012, 1A1FR2E, 1A1FR2ED, 1A1FR2G, 1A1FR2GD, 1A1FR2GD-VERS.2004, 1A1FR2G-VERS.2004, 1D1FR2ED, 1D1FR2G, 1D1FR2GD, 1D1FR2GD-VERS.2004, 1D1FR2G-VERS.2004		



			
1			
código	970951	referencia	36A5260
descripción	parrilla L 340mm An 240mm H 100mm para cocedora de pasta		
Para modelos:	0G1CP1E, 0G1CP1EC, 0G1CP1E-VERS.2004, 0G1CP1G, 0G1CP1G-VERS.2004, 1G1CP2G, 1G1CP2G-VERS.2004		

			
1			
código	970949	referencia	36A4641 36A4642
descripción	tamiz para empanar L 500mm An 295mm H 105mm acero inoxidable para cocedora de pasta		
Para modelos:	04WCP1EM, 091CP1E, 6040090, 6040310, 6043850, 6043980		

			
1			
código	970849	referencia	3007230
descripción	tamiz para empanar L 335mm An 235mm H 148mm freidora		
Para modelos:	091FR3G, 091FR3GD, 0A1FR3G, 0A1FR3GD, 0D1FR3G, 0D1FR3GD, 0G1FR3G, 0G1FR3GD, 0G1FR7G, 191FR4G, 191FR4GD, 1A1FR4G, 1A1FR4GD, 1D1FR4G, 1D1FR4GD, 1G1FR4G, 1G1FR4GD, 1G1FR8G		

cestos de lavado

cestos de alambre de acero redondos

cestas de lavado

			
1			
código	970323	referencia	3053810
descripción	cesta para vajillas diversas ø ext. 370mm H 145mm soporte ø 325mm		

cestos de plástico redondos

			
1			
código	970699	referencia	3053810
descripción	cesta para vajillas diversas ø ext. 380mm H 170mm soporte ø 325mm plástico		

rejillas y rieles guía

rejillas

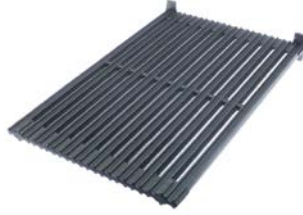
			
1			
código	210042	referencia	3000930 3000931
descripción	rejilla L 470mm An 300mm H 55mm hierro fundido apto para ANGELO PO grill		
Para modelos:	1G0GRG		

parrillas





universal

sin reborde

				
1				
código	970120	referencia	36M3540 G610	
descripción	parrilla An 325mm P 530mm GN 1/1 acero cromado anillo externo reforzado 7mm refuerzos longitudinales 4mm traviesas 1			
Para modelos:	31GE, 31TC, 31TCE, 32TC, 32TCE			
accesorios para	970120			
	código	690330	referencia	—
	cremallera L 1000mm An 22mm H 4mm tamaño orificio 3x8mm dist. del agujero 12.5mm acero inoxidable			
	código	694700	referencia	—
	soporte de bandeja L 31/28mm An 22mm H 18mm inox UE 12 pzs			
	código	694701	referencia	—
	soporte de bandeja L 31/28mm An 22mm H 17mm inox con gancho UE 12 pzs			







1

código	970125	referencia	32A2430 36A2430
descripción	parrilla An 325mm P 530mm GN 1/1 acero plastificado traviesas 1 blanco apto para refrigerador		
Para modelos:	BRPR218, BRPR21C, BRVR218, BRVR21C, K16APGPZ, K16XPZAP, SA16AGB, SA16GB, SL21RPR, SL21RVR		
accesorios para	970125		
	código	referencia	—
	690330		
	código	referencia	—
	694700		
	código	referencia	—
	694701		
	código	referencia	—
	694701		
	código	referencia	—





1

código	970122	referencia	G610X
descripción	parrilla An 325mm P 530mm GN 1/1 H 8mm acero inoxidable anillo externo reforzado 7mm refuerzos longitudinales 4mm traviesas 1		
accesorios para	970122		
	código	referencia	—
	690330		
	código	referencia	—
	694700		
	código	referencia	—
	694701		
	código	referencia	—



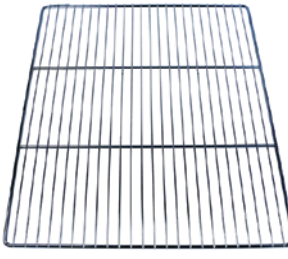

1

código	970132	referencia	36A0131
descripción	parrilla An 400mm P 600mm acero plastificado traviesas 1 blanco apto para refrigerador		
Para modelos:	40, 40-OPR01, 40CP, 40CP-OPR01, 40CPX, 40CPX-OPR01, 40PV, 40PV-OPR01, 40X, 40X-OPR01, 40XPV		
accesorios para	970132		
	código	referencia	—
	690330		
	código	referencia	—
	694700		
	código	referencia	—
	694701		
	código	referencia	—



1

código	970123	referencia	G241X
descripción	parrilla An 650mm P 530mm GN 2/1 acero inoxidable anillo externo reforzado 7.8mm refuerzos longitudinales 3.8mm traviesas 2 apto para refrigerador		
accesorios para	970123		
	código	referencia	—
	690330		
	código	referencia	—
	694700		
	código	referencia	—
	694701		
	código	referencia	—

con reborde



1

código	970558	referencia	3012000
descripción	parrilla An 325mm P 530mm GN 1/1 hierro cromado		
Para modelos:	1G1FA0EV, 1G1FA0GV, 1G1PE1EV, 1G1PE2EV, 2G1FA0GV, 2G1PE1EV, 2G1PE2EV, 31GE, 31TC, 31TCE, 32TC, 32TCE		



1

código	970555	referencia	36A0990
descripción	parrilla An 530mm P 650mm GN 2/1 acero cromado con tope para frigorífico		
Para modelos:	191FAAE, 191FAAG, 191FABG, 191FADG, 191FAE, 191FAG, 191PE4E, 191TPG, 1A1FA1G, 1A1FA2G, 1A1FA4G, 1A1FA5G, 1A1FAAG, 1A1FABG, 1A1FAS2G, 1A1FASG, 1A1PE4E, 1A1PEFTE, 1A1TP0G, 1A1TP0G-VERS.2002, 1A1FBE, 1D1FA1G, 1D1FA2G, 1D1FA4G, 1D1FA5G, 1D1FAAG, 1D1FABG, 1D1FAS2G, 1D1FASG, 1D1PE4E, 1D1TP0G, 1D1TP0G-VERS.2002, 1D1FBE, 1G1FA0E, 1G1FA0G, 1G1FABG, 1G1FAPG, 1G1PE1E, 1G1PE2E, 1G1TP0G, 291FAG, 291TPCG, 2A1FA1G, 2A1FA4G, 2A1FAAG, 2A1FAS2G, 2A1FASG, 2A1TP3G, 2A1TP6G, 2A1TPCG...(Otros modelos se puede ver en la tienda web)		



1

código	970527	referencia	36A0990 G241
descripción	parrilla An 530mm P 650mm GN 2/1 acero cromado con tope traviesas 2 apto para refrigerador		
accesorios para	970527		
	código	referencia	—
	690330		
	cremallera L 1000mm An 22mm H 4mm tamaño orificio 3x8mm dist. del agujero 12.5mm acero inoxidable		
	código	referencia	—
	694700		
	soporte de bandeja L 31/28mm An 22mm H 18mm inox UE 12 pzs		
	código	referencia	—
	694701		
	soporte de bandeja L 31/28mm An 22mm H 17mm inox con gancho UE 12 pzs		



1

código	970556	referencia	36A0710 36A1040 36A3630 RGP/2-1
descripción	parrilla An 530mm P 650mm GN 2/1 acero plastificado con tope anillo externo reforzado 9mm refuerzos longitudinales 5mm traviesas 2 blanco apto para refrigerador		
Para modelos:	135, 135-4, 135A, 135B, 135BA, 135BN, 135BNX, 135BX, 135BXE, 135BXR, 135CPX, 135NN, 135NNX, 135PVX, 135X, 135X-3, 135X-4, 135XE, 135XR, 65, 65A, 65B, 65BA, 65BX, 65BX-2, 65BXE, 65BXR, 65NB, 65NBX, 65NN, 65NNX, 65PVX, 65X, 65X-2, 65XE, 65XR, CX140, CX140B, CX140BN, CX140BR, CX140CP, CX140NN, CX140PV, CX140R, CX150, CX150B, CX150BN, CX150BR, CX150CP, CX150NN...(Otros modelos se puede ver en la tienda web)		
accesorios para	970556		
	código	referencia	—
	690330		
	cremallera L 1000mm An 22mm H 4mm tamaño orificio 3x8mm dist. del agujero 12.5mm acero inoxidable		
	código	referencia	—
	690332		
	soporte de bandeja L 31/28mm An 22mm H 17mm inox con gancho UE 1 pzs		
	código	referencia	—
	694700		
	soporte de bandeja L 31/28mm An 22mm H 18mm inox UE 12 pzs		
	código	referencia	—
	694701		
	soporte de bandeja L 31/28mm An 22mm H 17mm inox con gancho UE 12 pzs		



1

código	970643	referencia	36A3010
descripción	parrilla An 555mm P 510mm H 60mm acero plastificado con tope traviesas 1		
Para modelos:	120, 120B, 120NN, 120PV, 55, 55B, 55PV, SP120, SP120B, SP120BN, SP120NN, SP55, SP55B		
accesorios para	970643		
	código	referencia	—
	690330		
	cremallera L 1000mm An 22mm H 4mm tamaño orificio 3x8mm dist. del agujero 12.5mm acero inoxidable		
	código	referencia	—
	694700		
	soporte de bandeja L 31/28mm An 22mm H 18mm inox UE 12 pzs		
	código	referencia	—
	694701		
	soporte de bandeja L 31/28mm An 22mm H 17mm inox con gancho UE 12 pzs		



			
1			
código	970557	referencia	36A3020
descripción	parrilla An 555mm P 670mm acero plastificado con tope traviesas 2 apto para refrigerador		
accesorios para	970557		
	código	referencia	—
	690330		
	cremallera L 1000mm An 22mm H 4mm tamaño orificio 3x8mm dist. del agujero 12.5mm acero inoxidable		
	código	referencia	—
	694700		
	soporte de bandeja L 31/28mm An 22mm H 18mm inox UE 12 pzs		
	código	referencia	—
	694701		
	soporte de bandeja L 31/28mm An 22mm H 17mm inox con gancho UE 12 pzs		

			
1			
código	695577	referencia	36G8640
descripción	portarrejillas L 20mm H 15.5mm An 11mm plástico		
Para modelos:	6JA, 6JA2, 6JA2A, 6JA2M, 6JAA, 6JAM, 6JB, 6JB2, 6JB2A, 6JB2M, 6JB4A, 6JB4M, 6JBA, 6JBM, 6MRA, 6MRA2, 6MRA2A, 6MRA2M, 6MRA2Z, 6MRA4, 6MRA4A, 6MRA4M, 6MRA4Z, 6MRAA, 6MRAM, 6MRAZ, 6MRB, 6MRB11, 6MRB11A, 6MRB11M, 6MRB11Z, 6MRB2, 6MRB2A, 6MRB2M, 6MRB2Z, 6MRB4, 6MRB4A, 6MRB4M, 6MRB4Z, 6MRB6, 6MRB6A, 6MRB6M, 6MRB6Z, 6MRBA, 6MRBM, 6MRBZ, 6MRC, 6MRC11, 6MRC11A, 6MRC11M... (Otros modelos se puede ver en la tienda web)		

rejillas para chimeneas

			
1			
código	210248	referencia	36C4230
descripción	rejilla de chimenea		
Para modelos:	08WFA4E, 08WFA4G, 12WFA6E, 12WFA6G, 12WFAAN, 1B0FAS, 1B0FAS2, 1B1FAS2G, 1B1FASG, 6043590		

rieles guía y soportos

específico del fabricante

			
1			
código	690657	referencia	36D9470
descripción	cremallera L 650mm An 34mm H 57mm pos. de montaje vertical		
Para modelos:	120PV, 135, 135-4, 135A, 135B, 135BA, 135BN, 135BNX, 135BX, 135BXE, 135BXR, 135CPX, 135NN, 135NNX, 135X, 135X-3, 135X-4, 135XE, 135XR, 55PV, 65, 65A, 65B, 65BA, 65BX, 65BX-2, 65BXE, 65BXR, 65PVX, 65X, 65X-2, 65XE, 65XR		

			
1			
código	691925	referencia	35V6610
descripción	guía forma U L 430mm An 13mm pos. de montaje derecho altura interior 21mm		
Para modelos:	40CP, 40CPX		

portarrejillas

			
1			
código	695572	referencia	36M7340
descripción	portarrejillas		
Para modelos:	6MRA, 6MRA2, 6MRA2A, 6MRA2M, 6MRA2Z, 6MRA4, 6MRA4A, 6MRA4M, 6MRA4Z, 6MRAA, 6MRAM, 6MRAZ, 6MRB, 6MRB11, 6MRB11A, 6MRB11M, 6MRB11Z, 6MRB2, 6MRB2A, 6MRB2M, 6MRB2Z, 6MRB4, 6MRB4A, 6MRB4M, 6MRB4Z, 6MRB6, 6MRB6A, 6MRB6M, 6MRB6Z, 6MRBA, 6MRBM, 6MRBZ, 6MRC, 6MRC11, 6MRC11A, 6MRC11M, 6MRC11Z, 6MRC2, 6MRC2A, 6MRC2M, 6MRC2Z, 6MRC4, 6MRC4A, 6MRC4M, 6MRC4Z, 6MRC6, 6MRC6A, 6MRC6M, 6MRC6Z, 6MRCA... (Otros modelos se puede ver en la tienda web)		

			
1			
código	691841	referencia	35V6620
descripción	guía forma U L 430mm An 13mm pos. de montaje izquierdo altura interior 21mm		
Para modelos:	40CP, 40CPX		

juntas

juntas para frigoríficos

juntas insertables

perfil 9048

Fabricamos burletes personalizables de este perfil

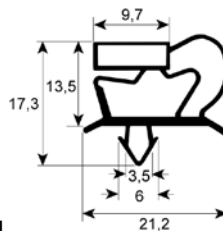

1	código	900863	referencia	37Q4730
	descripción	junta para frigorífico perfil 9048 An 138mm L 373mm medida inserción		
	Para modelos:	6BMA11A, 6BMA11M, 6BMA11Z, 6BMA3A, 6BMA3M, 6BMA3Z, 6BMB11A, 6BMB11M, 6BMB11Z, 6BMB22A, 6BMB22M, 6BMB22Z, 6BMB3A, 6BMB3M, 6BMB3Z, 6BMC11A, 6BMC11M, 6BMC11Z, 6BMC22A, 6BMC22M, 6BMC22Z, 6BMC33A, 6BMC33M, 6BMC33Z, 6BMC3A, 6BMC3M, 6BMC3Z, 6EA11, 6EA11A, 6EA11M, 6EA13, 6EA13A, 6EA13M, 6EB11, 6EB11A, 6EB11M, 6EB13, 6EB13A, 6EB13M, 6EB22, 6EB22A, 6EB22M, 6EC11, 6EC11A, 6EC11M, 6EC13, 6EC13A, 6EC13M, 6EC22, 6EC22A... (Otros modelos se puede ver en la tienda web)		

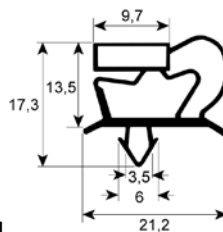

1	código	900862	referencia	37Q4720
	descripción	junta para frigorífico perfil 9048 An 246mm L 373mm medida inserción		
	Para modelos:	6BMA2A, 6BMA2M, 6BMA2Z, 6BMB2A, 6BMB2M, 6BMB2Z, 6BMB4A, 6BMB4M, 6BMB4Z, 6BMC2A, 6BMC2M, 6BMC2Z, 6BMC4A, 6BMC4M, 6BMC4Z, 6BMC6A, 6BMC6M, 6BMC6Z, 6EA2, 6EA2A, 6EA2M, 6EB2, 6EB2A, 6EB2M, 6EB4, 6EB4A, 6EB4M, 6EC2, 6EC2A, 6EC2M, 6EC4, 6EC4A, 6EC4M, 6ERA2, 6ERA2A, 6ERA2M, 6ERB2, 6ERB2A, 6ERB2M, 6ERB4, 6ERB4A, 6ERB4M, 6ERC2, 6ERC2A, 6ERC2M, 6MA2, 6MA2A, 6MA2M, 6MB2, 6MB2A... (Otros modelos se puede ver en la tienda web)		

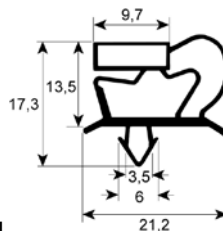

1	código	900860	referencia	37Q3950
	descripción	junta para frigorífico perfil 9048 An 253mm L 373mm medida inserción		
	Para modelos:	6JA2, 6JA2A, 6JA2M, 6JB2, 6JB2A, 6JB2M, 6JB4A, 6JB4M, 6SMA2, 6SMA2A, 6SMA2B, 6SMA2M, 6SMA2Z, 6SMA4Z, 6SMB2, 6SMB2A, 6SMB2B, 6SMB2M, 6SMB2Z, 6SMB4, 6SMB4A, 6SMB4B, 6SMB4M, 6SMB4Z, 6SMB6Z, 6SMC2, 6SMC2A, 6SMC2B, 6SMC2M, 6SMC2Z, 6SMC4, 6SMC4A, 6SMC4B, 6SMC4M, 6SMC4Z, 6SMC6, 6SMC6A, 6SMC6B, 6SMC6M, 6SMC6Z, 6SMC8Z		

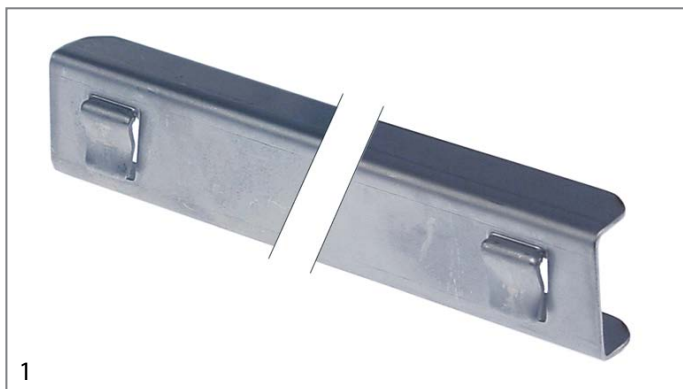

1	código	970888	referencia	35R9140
	descripción	guía forma U L 638mm An 13mm H 20mm pos. de montaje derecho/izquierdo		
	Para modelos:	CX140, CX140B, CX140BN, CX140BR, CX140CP, CX140NN, CX140PV, CX140R, CX150, CX150B, CX150BN, CX150BR, CX150CP, CX150NN, CX150PV, CX150R, CX65, CX652, CX65B, CX65BR, CX65NB, CX65NCP, CX65NN, CX65PV, CX65R, CX70, CX702, CX70B, CX70BR, CX70NB, CX70NN, CX70PV, CX70R, FX150, FX150B, FX150NN, FX70, FX70B, ISFEB, ISFEN, MD150, MD1504, MD150B, MD150B4, MD150BB, MD150BN, MD150BPV, MD150BR, MD150NCP, MD150NN... (Otros modelos se puede ver en la tienda web)		



1	código	701466	referencia	3069940
	descripción	guía L-Form L 600mm An 20mm H 30mm pos. de montaje derecho		
	Para modelos:	BP53G, BP53V, BP53X, BP64G, BP64V, BP64X, BP83A, BP83G, BP83M, BP83V, BP83X, BP94G, BP94V, BP94X, BPZ16, BPZ163A, BPZ163B, BPZ163S, BPZ167A, BPZ167B, BPZ167S, BPZ20, BPZ203A, BPZ203B, BPZ203S, BPZ207A, BPZ207B, BPZ207S, BPZ25, BPZ253A, BPZ253B, BPZ257A, BPZ257B, BS11, BS11A, BS11M, BS16, BS16A, BS16M, BS21, BS21A, BS21M, BSR11, BSR11A, BSR11M, BSR16, BSR16A, BSR16M, BSR21, BSR21A... (Otros modelos se puede ver en la tienda web)		



1	código	701465	referencia	3069950
	descripción	guía L-Form L 600mm An 20mm H 30mm pos. de montaje izquierdo		
	Para modelos:	BP53G, BP53V, BP53X, BP64G, BP64V, BP64X, BP83A, BP83G, BP83M, BP83V, BP83X, BP94G, BP94V, BP94X, BPZ16, BPZ163A, BPZ163B, BPZ163S, BPZ167A, BPZ167B, BPZ167S, BPZ20, BPZ203A, BPZ203B, BPZ203S, BPZ207A, BPZ207B, BPZ207S, BPZ25, BPZ253A, BPZ253B, BPZ257A, BPZ257B, BS11, BS11A, BS11M, BS16, BS16A, BS16M, BS21, BS21A, BS21M, BSR11, BSR11A, BSR11M, BSR16, BSR16A, BSR16M, BSR21, BSR21A... (Otros modelos se puede ver en la tienda web)		

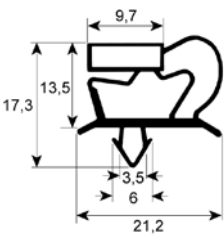

código	900864	referencia	37Q4740
descripción	junta para frigorífico perfil 9048 An 354mm L 373mm medida inserción		
Para modelos:	6BMA11A, 6BMA11M, 6BMA11Z, 6BMB11A, 6BMB11M, 6BMB11Z, 6BMB22A, 6BMB22M, 6BMB22Z, 6BMC11A, 6BMC11M, 6BMC11Z, 6BMC22A, 6BMC22M, 6BMC22Z, 6BMC33A, 6BMC33M, 6BMC33Z, 6EA11, 6EA11A, 6EA11M, 6EB11, 6EB11A, 6EB11M, 6EB22, 6EB22A, 6EB22M, 6EC11, 6EC11A, 6EC11M, 6EC22, 6EC22A, 6EC22M, 6MB11, 6MB11A, 6MB11M, 6MC11, 6MC11A, 6MC11M, 6MRB11, 6MRB11A, 6MRB11M, 6MRC11, 6MRC11A, 6MRC11M, 6MRC11Z, 6RB11, 6RB11A, 6RB11M...(Otros modelos se puede ver en la tienda web)		

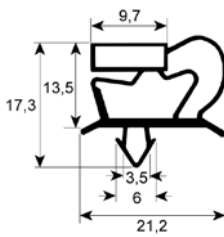

código	900812	referencia	37Q4490
descripción	junta para frigorífico perfil 9048 An 400mm L 650mm medida inserción para abatidor de temperatura		
Para modelos:	ART1L7, ART1L7A, ART1L7M, ART1LD7, ART1LD7A, ART1LD7M, B151M, BF51M, DA51, DA51A, DA51M, DS31, DS31A, DS31C, DS31M, DS51, DS51A, DS51C, DS51M, IA51, IA51A, IA51C, IA51M, IS51, IS51A, IS51AR, IS51C, IS51CR, IS51M, IS51MR, IS51R, IS51W, IS51WA, IS51WC, IS51WM, SM03LT7, SM03LT7A, SM03LT7M, SM1L7, SM1L7A, SM1L7FCV, SM1L7M, SM1LT7, SM1LT7A, SM1LT7M, VA51, VA51M, VS31, VS31M, VS51...(Otros modelos se puede ver en la tienda web)		

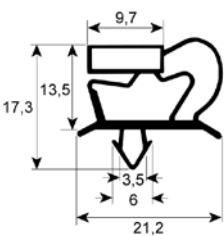

código	900861	referencia	37Q4710
descripción	junta para frigorífico perfil 9048 An 373mm L 570mm medida inserción		
Para modelos:	6BMA11A, 6BMA11B, 6BMA11M, 6BMA11Z, 6BMA2A, 6BMA2B, 6BMA2M, 6BMA2Z, 6BMA3A, 6BMA3B, 6BMA3M, 6BMA3Z, 6BMAA, 6BMAB, 6BMAM, 6BMAZ, 6BMB11A, 6BMB11B, 6BMB11M, 6BMB11Z, 6BMB22A, 6BMB22B, 6BMB22M, 6BMB22Z, 6BMB2A, 6BMB2B, 6BMB2M, 6BMB2Z, 6BMB3A, 6BMB3B, 6BMB3M, 6BMB3Z, 6BMB4A, 6BMB4B, 6BMB4M, 6BMB4Z, 6BMBA, 6BMBB, 6BMBM, 6BMBZ, 6BMC11A, 6BMC11B, 6BMC11M, 6BMC11Z, 6BMC22A, 6BMC22B, 6BMC22M, 6BMC22Z, 6BMC2A, 6BMC2B...(Otros modelos se puede ver en la tienda web)		

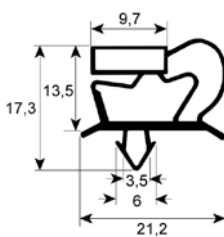

código	901207	referencia	37Q3810
descripción	junta para frigorífico perfil 9048 An 429mm L 675mm medida inserción para abatidor de temperatura		
Para modelos:	ART1L, ART1LA, ART1LD, ART1LDA, BF51H, DS351H, IS51H, IS51HW, SM1L, SM1LA, SM1LAM, SM1LAR, SM1LAT, SM1LAW, SM1LM, SM1LR, SM1LT, SM1LW		



imagen no disponible

código	902533	referencia	37Q4140
descripción	junta para frigorífico perfil 9048 An 450mm L 600mm medida inserción		

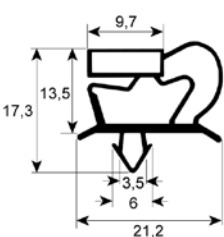

código	900709	referencia	37Q3870
descripción	junta para frigorífico perfil 9048 An 373mm L 580mm medida inserción		
Para modelos:	6JA, 6JA2, 6JA2A, 6JA2M, 6JAA, 6JAM, 6JB, 6JB2, 6JB2A, 6JB2M, 6JB4A, 6JB4M, 6JBA, 6JBM, 6SMA, 6SMA2, 6SMA2A, 6SMA2B, 6SMA2M, 6SMA2Z, 6SMAA, 6SMAB, 6SMAM, 6SMAZ, 6SMB, 6SMB2, 6SMB2A, 6SMB2B, 6SMB2M, 6SMB2Z, 6SMB4, 6SMB4A, 6SMB4B, 6SMB4M, 6SMB4Z, 6SMB, 6SMBB, 6SMBM, 6SMBZ, 6SMC, 6SMC2, 6SMC2A, 6SMC2B, 6SMC2M, 6SMC2Z, 6SMC4, 6SMC4A, 6SMC4B, 6SMC4M, 6SMC4Z...(Otros modelos se puede ver en la tienda web)		

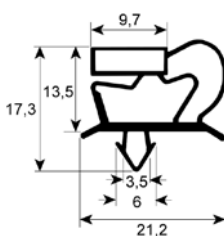

código	900712	referencia	37Q1020 37Q4850
descripción	junta para frigorífico perfil 9048 An 595mm L 1590mm medida inserción		
Para modelos:	S1200, S1200B, S1200BE, S1200E, S125, S125B, S125BE, S125BX, S125E, S125X, S60, S600, S600B, S600BE, S600E, S60B, S60BE, S60BX, S60E, S60X		

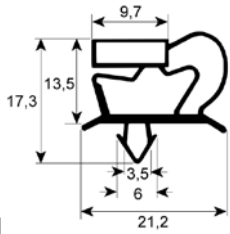

1

código	900710	referencia	37Q5450
descripción	junta para frigorífico perfil 9048 An 655mm L 1500mm medida inserción		
Para modelos:	AGL6B, CX120, CX120B, CX120NN, CX140, CX140B, CX140BN, CX140BR, CX140CP, CX140NN, CX140R, CX55, CX55B, CX65, CX65B, CX65BR, CX65R, GD150, GD150B, GD70, GD70B, MD130, MD130B, MD130BN, MD130NN, MD150, MD150B, MD150BB, MD150BN, MD150BR, MD150NCP, MD150NN, MD150R, MD60, MD60B, MD70, MD70B, MD70BR, MD70CP, MD70R, MDE150, MDE150B, MDE70, MDE70B, MX120, MX120B, MX120NN, MX140, MX140B, MX140NN... (Otros modelos se puede ver en la tienda web)		

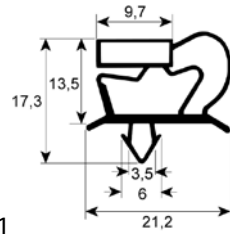

1

código	900351	referencia	37Q2590
descripción	junta para frigorífico perfil 9048 An 672mm L 1587mm medida inserción puerta		
Para modelos:	120, 120B, 120NN, 135, 135A, 135B, 135BA, 135BN, 135BNX, 135BX, 135BXE, 135BXR, 135CPX, 135NN, 135NNX, 135X, 135X-3, 135XE, 135XR, 55, 55B, 55PV, 65, 65A, 65B, 65BA, 65BX, 65BXE, 65BXR, 65X, 65XE, 65XR, SP120, SP120B, SP120BN, SP120NN, SP135, SP135B, SP135BN, SP135CP, SP135NN, SP55, SP55B, SP65, SP65B		

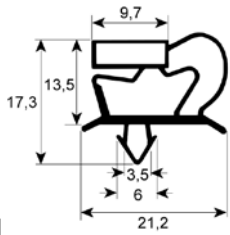

1

código	901329	referencia	37Q5460
descripción	junta para frigorífico perfil 9048 An 655mm L 704mm medida inserción		
Para modelos:	CX140CP, CX652, CX65NB, CX65NCP, CX65NN, MD1504, MD150B4, MD702, MD70B2, MD70NB, MD70NCP, MD70NN, PD150CP, PD702, PD70B2		

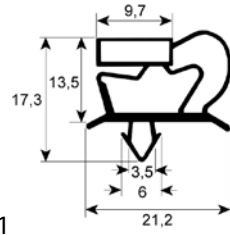

1

código	900328	referencia	37Q1370
descripción	junta para frigorífico perfil 9048 An 675mm L 1525mm medida inserción puerta de vidrio		
Para modelos:	40EV, 40EVP, 40PV, 40XPV		

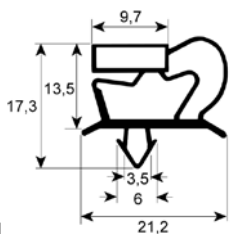

1

código	900706	referencia	37Q4370
descripción	junta para frigorífico perfil 9048 An 660mm L 1610mm medida inserción		
Para modelos:	CX130, CX130B, CX130NN, CX150, CX150B, CX150BN, CX150BR, CX150CP, CX150NN, CX150R, CX60, CX60B, CX70, CX70B, CX70BR, CX70R, FX150, FX150B, FX150NN, FX70, FX70B, MX130, MX130B, MX130NN, MX150, MX150B, MX150NN, MX60, MX60B, MX70, MX70B		

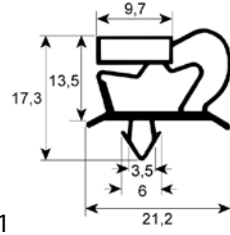

1

código	901206	referencia	37Q3800
descripción	junta para frigorífico perfil 9048 An 675mm L 820mm medida inserción para abatidor de temperatura		
Para modelos:	ART2LD, ART2SD, SM2L, SM2LR, SM2LW, SM2S, SM2SR, SM2SW		

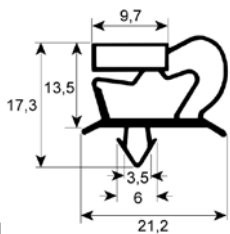

1

código	900350	referencia	37Q2600
descripción	junta para frigorífico perfil 9048 An 670mm L 760mm medida inserción 1/2 puerta		
Para modelos:	135-4, 135CPX, 135X-3, 135X-4, 65BX-2, 65NB, 65NBX, 65NN, 65NNX, 65X-2, SP135CP, SP65NB, SP65NN		

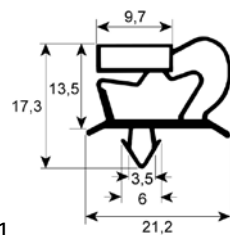

1

código	900326	referencia	37Q1380
descripción	junta para frigorífico perfil 9048 An 685mm L 1600mm medida inserción puerta de vidrio		
Para modelos:	120PV, 135PVX, 65PVX		



código	901205	referencia	37Q5340
descripción	junta para frigorífico perfil 9048 An 690mm L 835mm medida inserción para abatidor de temperatura		
Para modelos:	B1101S, BF101L, BF101S, IA101L, IA101S, IS101L, IS101LR, IS101LW, IS101S, IS101SR, IS101SW, VS101L, XA101L, XA101S, XS101L, XS101S		

código	902314	referencia	37Q5510
descripción	junta para frigorífico perfil 9046 An 520mm L 1495mm medida inserción		
Para modelos:	AF1B, AF1B-OPR01, AF1N, AF1N-OPR01, FSD1B, FSD1B-OPR01, FSD1N, FSD1N-OPR01, FSDR1B-OPR01, FSDR1N-OPR01		

código	901204	referencia	37Q5380
descripción	junta para frigorífico perfil 9048 An 941mm L 1002mm medida inserción para abatidor de temperatura		
Para modelos:	IA72S, IS102S, IS102SR, IS102SR-0NR01, IS102SW, IS72S, IS72SR, IS72SW		

código	901801	referencia	37Q4470
descripción	junta para frigorífico perfil 9046 An 650mm L 750mm medida inserción		
Para modelos:	CX150CP, CX702, CX70NB, CX70NN		

código	902258	referencia	N/A
descripción	junta para frigorífico perfil 9048 Anmm L 2500mm		

código	902257	referencia	N/A
descripción	junta para frigorífico perfil 9046 Anmm L 2500mm		

perfil 9046

Fabricamos burlletes personalizables de este perfil

código	902515	referencia	3125970
descripción	junta para frigorífico perfil 9046 An 377mm L 395mm medida inserción		
Para modelos:	3G6SA, 3G6SA2, 3G6SA4, 4G6SB, 4G6SB2, 4G6SB4, 4G6SB6, 6BR15V, 6BR15VC, 6BR19V, 6BR19VC, 6SA, 6SA2, 6SA2M, 6SAM, 6SB, 6SB2, 6SB2M, 6SBM		

perfil 9704

Fabricamos burlletes personalizables de este perfil

código	902315	referencia	37Q5490
descripción	junta para frigorífico perfil 9704 An 655mm L 1500mm medida inserción		
Para modelos:	CX140PV, CX65PV, MD150BPV, MD150PV, MD70BPV, MD70PV, PD70B-PV, PD70PV, TE140PV, TE65PV		

perfil 9753

Fabricamos burletes personalizables de este perfil

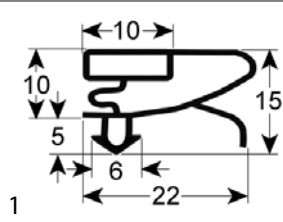

código	900875	referencia	N/A
descripción	junta para frigorífico perfil 9753 Anmm L 2500mm		

perfil 9333

Fabricamos burletes personalizables de este perfil

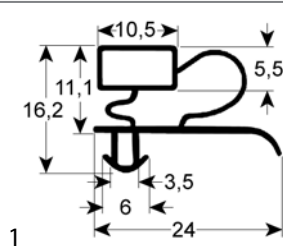

código	900016	referencia	37Q1890
descripción	junta para frigorífico perfil 9333 An 650mm L 1550mm medida inserción 1/2 puerta		

perfil 9012

Fabricamos burletes personalizables de este perfil

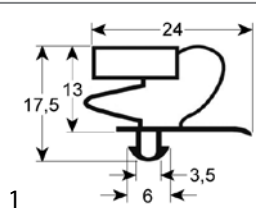

código	900354	referencia	37Q7730
descripción	junta para frigorífico perfil 9012 An 130mm L 367mm medida inserción cajón tamaño 1/3		
Para modelos:	6BEA11A, 6BEA11B, 6BEA11M, 6BEA11Z, 6BEA3A, 6BEA3B, 6BEA3M, 6BEA3Z, 6BEB11A, 6BEB11M, 6BEB11Z, 6BEB22A, 6BEB22M, 6BEB22Z, 6BEB3A, 6BEB3B, 6BEB3M, 6BEB3Z, 6BEC11A, 6BEC11B, 6BEC11M, 6BEC11Z, 6BEC22A, 6BEC22B, 6BEC22M, 6BEC22Z, 6BEC33A, 6BEC33B, 6BEC33M, 6BEC33Z, 6BEC3A, 6BEC3B, 6BEC3M, 6BEC3Z, 6BMA11A, 6BMA11B, 6BMA11M, 6BMA11Z, 6BMA3A, 6BMA3M, 6BMA3Z, 6BMB11A, 6BMB11B, 6BMB11M, 6BMB11Z, 6BMB22A, 6BMB22B, 6BMB22M, 6BMB22Z, 6BMB3A...(Otros modelos se puede ver en la tienda web)		

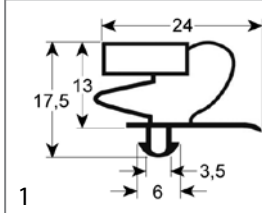

código	900353	referencia	37Q7690
descripción	junta para frigorífico perfil 9012 An 242mm L 367mm medida inserción cajón tamaño 1/2		
Para modelos:	6BEA2A, 6BEA2B, 6BEA2M, 6BEA2Z, 6BEB2A, 6BEB2B, 6BEB2M, 6BEB2Z, 6BEB4A, 6BEB4B, 6BEB4M, 6BEB4Z, 6BEC2A, 6BEC2B, 6BEC2M, 6BEC2Z, 6BEC4A, 6BEC4B, 6BEC4M, 6BEC4Z, 6BEC6A, 6BEC6B, 6BEC6M, 6BEC6Z, 6BMA2M, 6BMA2Z, 6BMB2B, 6BMB2M, 6BMB2Z, 6BMB4A, 6BMB4B, 6BMB4M, 6BMB4Z, 6BMC2A, 6BMC2B, 6BMC2M, 6BMC2Z, 6BMC4A, 6BMC4B, 6BMC4M, 6BMC4Z, 6BMC6A, 6BMC6B, 6BMC6M, 6BMC6Z, 6FMA2A, 6FMA2B, 6FMA2M, 6FMA2Z, 6FMA4A...(Otros modelos se puede ver en la tienda web)		

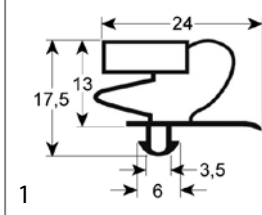

código	900325	referencia	37Q7720
descripción	junta para frigorífico perfil 9012 An 345mm L 362mm medida inserción cajón tamaño 2/3		
Para modelos:	6BEA11A, 6BEA11B, 6BEA11M, 6BEA11Z, 6BEB11A, 6BEB11M, 6BEB11Z, 6BEB22A, 6BEB22M, 6BEB22Z, 6BEC11A, 6BEC11B, 6BEC11M, 6BEC11Z, 6BEC22A, 6BEC22B, 6BEC22M, 6BEC22Z, 6BEC33A, 6BEC33B, 6BEC33M, 6BEC33Z, 6BMA11A, 6BMA11B, 6BMA11M, 6BMA11Z, 6BMB11A, 6BMB11B, 6BMB11M, 6BMB11Z, 6BMB22A, 6BMB22B, 6BMB22M, 6BMB22Z, 6BMC11A, 6BMC11B, 6BMC11M, 6BMC11Z, 6BMC22A, 6BMC22B, 6BMC22M, 6BMC22Z, 6BMC33A, 6BMC33B, 6BMC33M, 6BMC33Z, 6FMA11A, 6FMA11B, 6FMA11M, 6FMA11Z...(Otros modelos se puede ver en la tienda web)		

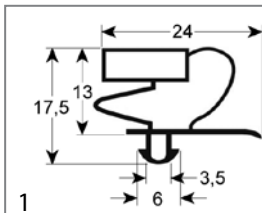

código	900352	referencia	37Q7590
descripción	junta para frigorífico perfil 9012 An 367mm L 567mm medida inserción puerta tamaño 1/1		
Para modelos:	6BEA11A, 6BEA11B, 6BEA11M, 6BEA11Z, 6BEA2A, 6BEA2B, 6BEA2M, 6BEA2Z, 6BEA3A, 6BEA3B, 6BEA3M, 6BEA3Z, 6BEA4A, 6BEA4B, 6BEA4M, 6BEA4Z, 6BEA5A, 6BEA5B, 6BEA5M, 6BEA5Z, 6BEB11M, 6BEB11Z, 6BEB22A, 6BEB22B, 6BEB22M, 6BEB22Z, 6BEB2A, 6BEB2B, 6BEB2M, 6BEB2Z, 6BEB3A, 6BEB3B, 6BEB3M, 6BEB3Z, 6BEB4A, 6BEB4B, 6BEB4M, 6BEB4Z, 6BEBA, 6BEBB, 6BEBBA, 6BEBBB, 6BEBBM, 6BEBBZ, 6BEBM, 6BEBZ, 6BEC11A, 6BEC11B...(Otros modelos se puede ver en la tienda web)		

código	900327	referencia	37Q0210
descripción	junta para frigorífico perfil 9012 An 657mm L 1512mm medida inserción puerta refrigeración		
Para modelos:	40, 40B, 40CP, 40CPX, 40PL, 40X		

código	900017	referencia	37Q2010
descripción	junta para frigorífico perfil 9012 An 657mm L 747mm medida inserción puerta/puerta de vidrio		

perfil 9251

código	901504	referencia	37Q4290
descripción	junta para frigorífico perfil 9251 An 750mm L 2000mm medida inserción 3 lados lado corto abierto		
Para modelos:	10003C, 10003CP, 10003CPB, 10043C, 10043CP, 10043CPB, 11703C, 11703CP, 11703CPB, 12003C, 12003CP, 12003CPB, 12043C, 12043CP, 12043CPB, 14003C, 14003CP, 14003CPB, 14043C, 14043CP, 14043CPB, 14343C, 14343CP, 14343CPB, 16743C, 16743CP, 16743CPB, 3103C, 3103CP, 3103CPB, 3743C, 3743CP, 3743CPB, 4103C, 4103CP, 4103CPB, 4943C, 4943CP, 4943CPB, 5103C, 5103CP, 5103CPB, 5403C, 5403CP, 5403CPB, 6103C, 6103CP, 6103CPB, 6143C, 6143CP...(Otros modelos se puede ver en la tienda web)		

juntas roscadas
perfil 9031

Fabricamos burletes personalizables de este perfil

código	901006	referencia	37Q0470
descripción	junta para frigorífico perfil 9031 An 614mm L 590mm medidas exteriores		

código	901005	referencia	37Q0450
descripción	junta para frigorífico perfil 9031 An 660mm L 1360mm medidas exteriores		

perfil 9140

Fabricamos burletes personalizables de este perfil

código	900705	referencia	37Q2050
descripción	junta para frigorífico perfil 9140 An 295mm L 380mm medidas exteriores		
Para modelos:	K16APGPZ, K16XPZAP, SA16AGB, SA16GB		

código	900009	referencia	37Q2040
descripción	junta para frigorífico perfil 9140 An 380mm L 610mm medidas exteriores		
Para modelos:	K16APGPZ, K16XPZAP, SA16AGB, SA16GB		

código	900858	referencia	37Q3210
descripción	junta para frigorífico perfil 9140 An 383mm L 531mm medidas exteriores		
Para modelos:	SA87		

código	900859	referencia	37Q3250
descripción	junta para frigorífico perfil 9140 An 459mm L 613mm medidas exteriores		

código	900717	referencia	37Q2380
descripción	junta para frigorífico perfil 9140 An 575mm L 610mm medidas exteriores		

código	901606	referencia	37Q3320
descripción	junta para frigorífico perfil 9140 An 600mm L 645mm medidas exteriores		
Para modelos:	BRPR, BRPR218, BRPR21C, BRPRV, BRVR, BRVR218, BRVR21C, BRVRV		

código	901657	referencia	37Q0760
descripción	junta para frigorífico perfil 9140 An 655mm L 1555mm medidas exteriores		

código	902264	referencia	N/A
descripción	junta para frigorífico perfil 9140 Anmm L 2500mm		

perfil 9106
Fabricamos burlletes personalizables de este perfil

código	902262	referencia	N/A
descripción	junta para frigorífico perfil 9106 Anmm L 2500mm		

perfil 9207

Fabricamos burlletes personalizables de este perfil

código	901004	referencia	37Q0770
descripción	junta para frigorífico perfil 9207 An 660mm L 755mm medidas exteriores		

código	902277	referencia	N/A
descripción	junta para frigorífico perfil 9207 Anmm L 2500mm		

código	902277	referencia	N/A
descripción	junta para frigorífico perfil 9207 Anmm L 2500mm		

juntas térmicas

juntas para ventanas

código	900058	referencia	37Q2470
descripción	junta de ventana perfil 1620 UE al metro		

código	900058	referencia	37Q2470
descripción	junta de ventana perfil 1620 UE al metro		

código	900442	referencia	37Q7400 37Q7401
descripción	junta de ventana perfil 1630 L 1075mm UE 1		
Para modelos:	FCV3EM, FCV4E, FCV4EDS, FCV4EM, FM423E1, FM423E2		

código	900442	referencia	37Q7400 37Q7401
descripción	junta de ventana perfil 1630 L 1075mm UE 1		
Para modelos:	FCV3EM, FCV4E, FCV4EDS, FCV4EM, FM423E1, FM423E2		

código	900447	referencia	37Q2981 37Q2982
descripción	junta de ventana perfil 1630 L 1350mm UE 1		
Para modelos:	71AR, 71ARE, 71RA, 91AR, 91ARE, 91RA, FC61, FC61E, FCV61, FCV61-CSA, FCV61DM, FCV61DM-CSA, FCV61DS, FCV61DS-CSA, FCV61E, FCV61EDM, FCV61EDM-UL, FCV61EDS, FCV61EDS-UL, FCV61E-UL		

código	900447	referencia	37Q2981 37Q2982
descripción	junta de ventana perfil 1630 L 1350mm UE 1		
Para modelos:	71AR, 71ARE, 71RA, 91AR, 91ARE, 91RA, FC61, FC61E, FCV61, FCV61-CSA, FCV61DM, FCV61DM-CSA, FCV61DS, FCV61DS-CSA, FCV61E, FCV61EDM, FCV61EDM-UL, FCV61EDS, FCV61EDS-UL, FCV61E-UL		

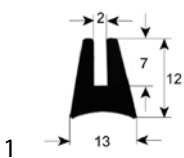

código	900448	referencia	37Q2991 37Q2992
descripción	junta de ventana perfil 1630 L 1800mm UE 1		
Para modelos:	FC101, FC101E, FCV101, FCV101-CSA, FCV101DM, FCV101DM-CSA, FCV101DS, FCV101DS-CSA, FCV101E, FCV101EDM, FCV101EDM-UL, FCV101EDS, FCV101EDS-UL, FCV101E-UL		

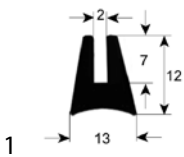

código	900449	referencia	37Q7530 37Q7531
descripción	junta de ventana perfil 1630 L 2050mm UE 1		
Para modelos:	FCV141, FCV141-CSA, FCV141DM, FCV141DM-CSA, FCV141DS, FCV141DS-CSA, FCV141E, FCV141EDM, FCV141EDS, FCV72EDM-UL, FCV72EDS-UL, FCV72E-UL		

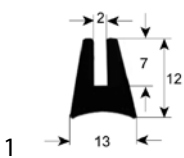

código	900450	referencia	37Q3000 37Q3001
descripción	junta de ventana perfil 1630 L 2700mm UE 1		
Para modelos:	FC241, FC241E, FC241G, FCV241, FCV241DM, FCV241DS, FCV241E, FCV241EDM, FCV241EDM-UL, FCV241EDS, FCV241EDS-UL, FCV241E-UL, FCV241G, FCV241G-CSA, FCV241GDM, FCV241GDM-CSA, FCV241GDS, FCV241GDS-CSA		

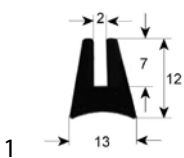

código	900730	referencia	N/A
descripción	junta de ventana perfil 1630 UE al metro		

juntas para puertas



código	900725	referencia	37Q7621
descripción	junta de puerta		
Para modelos:	FCV401DM, FCV401DM-CSA, FCV401EDM, FCV401EDM-UL		



código	900720	referencia	3031880
descripción	junta de puerta perfil 1855 UE al metro		
Para modelos:	1G1FA0E, 1G1FA0G, 1G1FABG, 1G1FAPG, 1G1PE1E, 1G1PE2E, 1G1T-P0G, 2G1FAGF, 2G1FA0E, 2G1FA0G, 2G1FABG, 2G1FACG, 2G1FADG, 2G1FADGV, 2G1FAPG, 2G1PE1E, 2G1PE2E, 2G1TP3G		

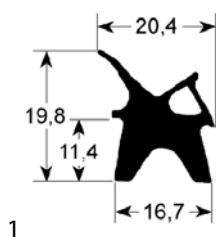

código	900059	referencia	37Q2480
descripción	junta de puerta perfil 2410 UE al metro		

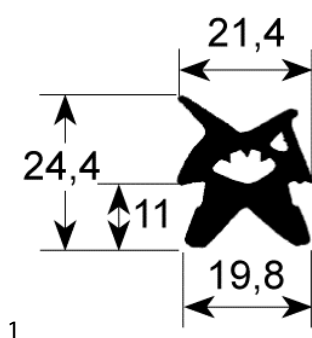

código	900441	referencia	37Q1001 37Q1002
descripción	junta de puerta perfil 2420 An 330mm L 410mm medidas exteriores UE 1		
Para modelos:	FCV3EM, FCV4E, FCV4EDS, FCV4EM		

código	900443	referencia	37Q0951 37Q0952
descripción	junta de puerta perfil 2420 An 450mm L 460mm medida inserción exterior UE 1 para CONVOTHERM		
Para modelos:	FC61, FC61E, FCV61, FCV61-CSA, FCV61DM, FCV61DM-CSA, FCV61DS, FCV61DS-CSA, FCV61E, FCV61EDM, FCV61EDM-UL, FCV61EDS, FCV61EDS-UL, FCV61E-UL		

código	900445	referencia	37Q0981 37Q0982
descripción	junta de puerta perfil 2420 An 565mm L 680mm medidas exteriores UE 1		
Para modelos:	FCV141, FCV141-CSA, FCV141DM, FCV141DM-CSA, FCV141DS, FCV141DS-CSA, FCV141E, FCV141EDM, FCV141EDS, FCV72EDM-UL, FCV72EDS-UL, FCV72E-UL		

código	900444	referencia	37Q0970 37Q0971 37Q0972
descripción	junta de puerta perfil 2420 An 450mm L 700mm medida inserción exterior UE 1 para CONVOTHERM		
Para modelos:	FC101, FC101E, FCV101, FCV101-CSA, FCV101DM, FCV101DM-CSA, FCV101DS, FCV101DS-CSA, FCV101E, FCV101EDM, FCV101EDM-UL, FCV101EDS, FCV101EDS-UL, FCV101E-UL		

código	900446	referencia	37Q0990 37Q0991 37Q0992
descripción	junta de puerta perfil 2420 An 670mm L 860mm medidas exteriores UE 1		
Para modelos:	FC241, FC241E, FC241G, FCV241, FCV241DM, FCV241DS, FCV241E, FCV241EDM, FCV241EDM-UL, FCV241EDS, FCV241EDS-UL, FCV241E-UL, FCV241G, FCV241G-CSA, FCV241GDM, FCV241GDM-CSA, FCV241GDS, FCV241GDS-CSA		

código	900713	referencia	37Q2952
descripción	junta de puerta perfil 2420 An 450mm L 700mm medidas exteriores UE 1		

código	900721	referencia	37Q7633
descripción	junta de puerta perfil 2420 An 680mm L 1380mm medidas exteriores UE 1		
Para modelos:	FCV401DM, FCV401DM-CSA, FCV401EDM, FCV401EDM-UL		

código	901394	referencia	37Q4980
descripción	junta de puerta perfil 2438 An 330mm L 410mm medidas exteriores		
Para modelos:	FCV3EM, FCV4E, FCV4EDS, FCV4EM, FM423E1, FM423E2		

código	900749	referencia	36E4061
descripción	junta de puerta perfil 2780 An 630mm L 690mm medidas exteriores UE 1		
Para modelos:	FM721E1, FM721E1-VERS.2006, FM721E2, FM721E2-VERS.2006, FM721E3, FM721E3-VERS.2006, FM721G1, FM721G1-VERS.2006, FM721G2, FM721G2-VERS.2006, FM721G3, FM721G3-VERS.2006		

código	900748	referencia	3050160
descripción	junta de puerta perfil 2780 An 475mm L 1360mm medidas exteriores UE 1		
Para modelos:	FM2011E2-VERS.2006, FM2011E3-VERS.2006, FM2011G2-VERS.2006, FM2011G3-VERS.2006		

código	900746	referencia	36E3921
descripción	junta de puerta perfil 2780 An 690mm L 1360mm medidas exteriores UE 1		
Para modelos:	FM2021E1, FM2021E2, FM2021E2-VERS.2006, FM2021E3, FM2021E3-VERS.2006, FM2021G1, FM2021G2, FM2021G2-VERS.2006, FM2021G3, FM2021G3-VERS.2006		

código	900716	referencia	36E3030 36E3031
descripción	junta de puerta perfil 2780 An 485mm L 485mm medidas exteriores UE 1		
Para modelos:	FC611E, FC611G, FM611E1, FM611E1-VERS.2006, FM611E2, FM611E2-VERS.2006, FM611E3, FM611E3-VERS.2006, FM611G1, FM611G1-VERS.2006, FM611G2, FM611G2-VERS.2006, FM611G3, FM611G3-VERS.2006		

código	900747	referencia	36E3520 36E3521
descripción	junta de puerta perfil 2780 An 690mm L 860mm medidas exteriores UE 1		
Para modelos:	FC1221E, FC1221G, FM1221E1, FM1221E1-VERS.2006, FM1221E2, FM1221E2-VERS.2006, FM1221E3, FM1221E3-VERS.2006, FM1221G1, FM1221G1-VERS.2006, FM1221G2, FM1221G2-VERS.2006, FM1221G3, FM1221G3-VERS.2006		

código	900715	referencia	36E3020 36E3021
descripción	junta de puerta perfil 2780 An 490mm L 700mm medidas exteriores UE 1		
Para modelos:	FC1011E, FC1011G, FM1011E1, FM1011E1-VERS.2006, FM1011E2, FM1011E2-VERS.2006, FM1011E3, FM1011E3-VERS.2006, FM1011G1, FM1011G1-VERS.2006, FM1011G2, FM1011G2-VERS.2006, FM1011G3, FM1011G3-VERS.2006		

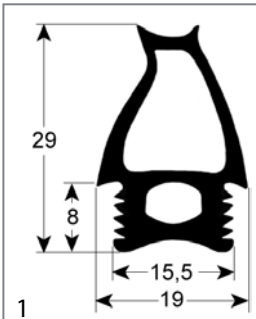

código	901624	referencia	3077280 3077281 3077282
descripción	junta de puerta perfil 2781 An 475mm L 1410mm medidas exteriores para ANGELO PO		
Para modelos:	FX201E2, FX201E2P, FX201E2P-VERS.032014, FX201E2-VERS.032014, FX201E3, FX201E3P, FX201E3P-VERS.022014, FX201E3-VERS.022014, FX201G2, FX201G2P, FX201G2P-VERS.032014, FX201G2-VERS.032014, FX201G3P, FX201G3-VERS.022014		

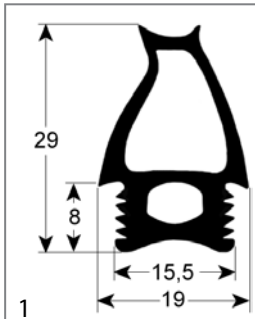

código	901623	referencia	3077270 3077271 3077272
descripción	junta de puerta perfil 2781 An 475mm L 725mm medidas exteriores para ANGELO PO		
Para modelos:	BX101E, BX101E-VERS.122013, BX101G, BX101G-VERS.122013, FX101E1, FX101E1R, FX101E2, FX101E2C, FX101E2C-VERS.032014, FX101E2R, FX101E2R-VERS.032014, FX101E2-VERS.032014, FX101E3, FX101E3C, FX101E3C-VERS.022014, FX101E3R, FX101E3R-VERS.022014, FX101E3-VERS.022014, FX101G1, FX101G1R, FX101G2, FX101G2C, FX101G2C-VERS.032014, FX101G2R, FX101G2R-VERS.032014, FX101G2-VERS.032014, FX101G3, FX101G3C, FX101G3C-VERS.022014, FX101G3R, FX101G3R-VERS.022014, FX101G3-VERS.022014, FX10E2CR, FX10E2CR-VERS.032014, FX10E3CR, FX10E3CR-VERS.022014, FX10G2CR, FX10G2CR-VERS.032014, FX10G3CR, FX10G3CR-VERS.022014		

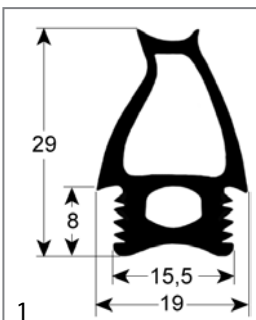

código	901622	referencia	3077260 3077261 3077262
descripción	junta de puerta perfil 2781 An 475mm L 475mm medidas exteriores para ANGELO PO		
Para modelos:	BX61E, BX61E-VERS.122013, BX61G, BX61G-VERS.122013, FX61E1, FX61E1R, FX61E2, FX61E2C, FX61E2CR, FX61E2CR-VERS.032014, FX61E2C-VERS.032014, FX61E2R, FX61E2R-VERS.032014, FX61E2-VERS.032014, FX61E3, FX61E3C, FX61E3CR, FX61E3CR-VERS.022014, FX61E3C-VERS.022014, FX61E3R, FX61E3R-VERS.022014, FX61E3-VERS.022014, FX61G1, FX61G1R, FX61G2, FX61G2C, FX61G2CR, FX61G2CR-VERS.032014, FX61G2C-VERS.032014, FX61G2R, FX61G2R-VERS.032014, FX61G2-VERS.032014, FX61G3, FX61G3C, FX61G3CR, FX61G3CR-VERS.022014, FX61G3C-VERS.022014, FX61G3R, FX61G3R-VERS.022014, FX61G3-VERS.022014		

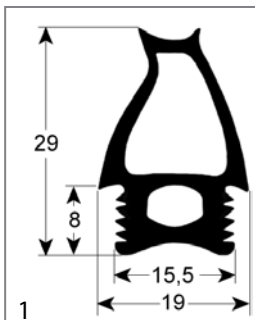

código	901625	referencia	3077290 3077291 3077292
descripción	junta de puerta perfil 2781 An 628mm L 686mm medidas exteriores para ANGELO PO		
Para modelos:	BX82E, BX82E-VERS.122013, BX82G, BX82G-VERS.122013, FX82E1, FX82E2, FX82E2C, FX82E2T, FX82E2T-VERS.032014, FX82E3, FX82E3C, FX82E3CT, FX82E3CT-VERS.022014, FX82E3T, FX82E3T-VERS.022014, FX82G1, FX82G2, FX82G2C, FX82G2T, FX82G2T-VERS.032014, FX82G3, FX82G3C, FX82G3CT, FX82G3CT-VERS.022014, FX82G3T, FX82G3T-VERS.022014		



código	901627	referencia	3077310 3077311 3077312
descripción	junta de puerta perfil 2781 An 688mm L 1410mm medidas exteriores para ANGELO PO		
Para modelos:	FX202E2, FX202E2-VERS.032014, FX202E3, FX202E3-230V-3-50Hz-60Hz, FX202E3-230V-3-50Hz-60Hz-VERS.022014, FX202E3-VERS.022014, FX202G2, FX202G2-VERS.032014, FX202G3, FX202G3-VERS.022014		

código	901626	referencia	3077300 3077301 3077302
descripción	junta de puerta perfil 2781 An 688mm L 886mm medidas exteriores para ANGELO PO		
Para modelos:	BX122E, BX122E-VERS.122013, BX122G, BX122G-VERS.122013, FX122E1, FX122E2, FX122E2C, FX122E2T, FX122E2T-VERS.032014, FX122E3, FX122E3C, FX122E3T, FX122E3T-VERS.022014, FX122G1, FX122G3, FX122G3C, FX122G3T, FX122G3T-VERS.022014, FX12E3CT, FX12E3CT-VERS.022014, FX12G3CT, FX12G3CT-VERS.022014		

juntas para bandejeros

código	902513	referencia	3040480
descripción	junta para carro porta bandejas perfil 4110 L 510mm UE 1		
Para modelos:	FM2011E2-VERS.2006, FM2011E3-VERS.2006, FM2011G2-VERS.2006, FM2011G3-VERS.2006		

código	901396	referencia	3039710
descripción	junta para carro porta bandejas perfil 4110 L 712mm UE 1		
Para modelos:	FM2021E2-VERS.2006, FM2021E3-VERS.2006, FM2021G2-VERS.2006, FM2021G3-VERS.2006		

código	902520	referencia	3091160 3199570
descripción	junta para carro porta bandejas perfil 4140 L 515mm UE 1		
Para modelos:	FX201E2, FX201E2P, FX201E2P-VERS.032014, FX201E2-VERS.032014, FX201E3, FX201E3P, FX201E3P-VERS.022014, FX201E3-VERS.022014, FX201G2, FX201G2P, FX201G2P-VERS.032014, FX201G2-VERS.032014, FX201G3P, FX201G3-VERS.022014		

juntas tóricas

EPDM

código	510551	referencia	3FL1123
descripción	junta de tapa de bomba int.ø 158.3mm tipo bomba 1214/1293/1225 /2243/1226/1204/3473/1241 espesor 3.53mm EPDM UE 1 pzs		

código	540682	referencia	3150840 37Q1210
descripción	junta tórica EPDM espesor 1.78mm int.ø 18.77mm UE 1 pzs		
Para modelos:	030BME, 030EBM, 030FE, 031BME, 031EBM, 04WBMEV, 08WGREV, 090BM1E, 090BM1G, 091CP1E, 091CP1G, 091FR1EX, 091FR7GS, 091FR7GX, 0A1CP1E, 0A1CP1G, 0B1CP1G, 0D1CP1E, 0D1CP1G, 0G1CP1E, 0G1CP1E-VERS.2004, 0G1CP1G, 0G1CP1G-VERS.2004, 190BM2E, 190BM2G, 190GRE, 191CP1G, 191CP2G, 1A1CP1G, 1A1CP2G, 1D1CP1G, 1D1CP2G, 1G0GRE, 1G1CP1G, 1G1CP1G-VERS.2004, 1G1CP2G, 1G1CP2G-VERS.2004, 30CPS, 30CPSE, 6040090, 6040110, 6040310, 6042680, 6043850, 6043980, 70CP, 71CP2, 90CP		



código	510303	referencia	3152180
descripción	junta tórica EPDM espesor 1.78mm int.ø 6.75mm UE 1 pzs		
Para modelos:	LC100, LC100-VERS.2001, LC130, LC130-VERS.2001, LC80, LF50, LF50E, LF50EM, LF50EMPS, LP124, LP124S-VERS.052006, LP124V, LP124-VERS.052006, LP124VS-VERS.052006, LP124V-VERS.052006, LP84, LP84S-VERS.052006, LP84V, LP84-VERS.052006, LP84VS-VERS.052006, LP84V-VERS.052006		



código	510177	referencia	3035830 3152210
descripción	junta tórica EPDM espesor 1.78mm int.ø 7.66mm UE 1 pzs		

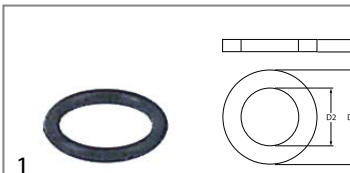

código	519181	referencia	3152400
descripción	junta tórica EPDM espesor 1mm int.ø 5mm UE 1 pzs		

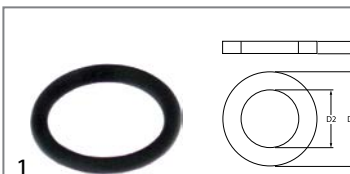

código	102997	referencia	3152550
descripción	junta tórica EPDM espesor 1mm int.ø 6mm UE 1 pzs		
Para modelos:	04WFAAV, 08WFA4E, 08WFA4G, 08WFAAE, 08WFAAG, 08WFAAV, 090FAA, 0A0FA1, 0A0FA4, 0A0FAA, 0D0FA1, 0D0FA4, 0D0FAA, 0G0FA0, 12WFA6E, 12WFA6G, 12WFAAA, 12WFAAE, 12WFAAG, 12WFAAN, 190FA, 190FAA, 190FAB, 190FAD, 191FAAE, 191FAAG, 191FABG, 191FADG, 191FAE, 191FAG, 1A0FA1, 1A0FA2, 1A0FA4, 1A0FA5, 1A0FAA, 1A0FAB, 1A1FA1G, 1A1FA2G, 1A1FA4G, 1A1FA5G, 1A1FAAG, 1A1FABG, 1D0FA1, 1D0FA2, 1D0FA4, 1D0FA5, 1D0FAA, 1D0FAB, 1D1FA1G, 1D1FA2G...(Otros modelos se puede ver en la tienda web)		



código	528223	referencia	3152100
descripción	junta tórica EPDM espesor 2.62mm int.ø 11.91mm UE 1 pzs		



código	518227	referencia	N/A
descripción	junta tórica EPDM espesor 2.62mm int.ø 12.37mm UE 1 pzs		

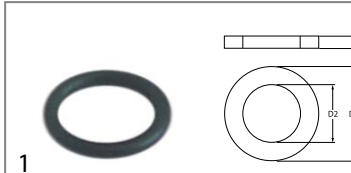

código	528333	referencia	3152410
descripción	junta tórica EPDM espesor 2.62mm int.ø 13.1mm UE 1 pzs		
Para modelos:	LC80		

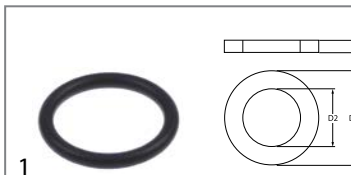

código	516026	referencia	3186287
descripción	junta tórica EPDM espesor 2.62mm int.ø 17.86mm UE 1 pzs		

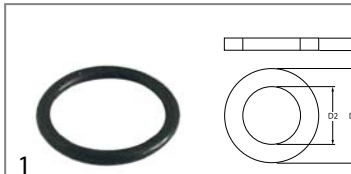

código	504590	referencia	3152170
descripción	junta tórica EPDM espesor 2.62mm int.ø 18.72mm UE 1 pzs		
Para modelos:	C165D, C165S, C165VD, C165VS, C207D, C207D-VERS.2006, C207S, C207S-VERS.2006, C207VD, C207VD-VERS.2006, C207VS, C207VS-VERS.2006, C304AD, C304AD-VERS.2006, C304AS, C304AS-VERS.2006, C304AVD, C304AVD-VERS.2006, C304AVS, C304AVS-VERS.2006, C304D, C304D-VERS.2006, C304S, C304S-VERS.2006, C304VD, C304VD-VERS.2006, C304VS, C304VS-VERS.2006, C92D-VERS.2006, C92S-VERS.2006, C92VD-VERS.2006, C92VS-VERS.2006, CS243D, CS243D-VERS.2006, CS243S, CS243S-VERS.2006, CS243VD, CS243VD-VERS.2006, CS243VS, CS243VS-VERS.2006, CS370AD, CS370AD-VERS.2006, CS370AS, CS370AS-VERS.2006, CS370AVD, CS370AVD-VERS.2006, CS370AVS, CS370AVS-VERS.2006, CS370D, CS370D-VERS.2006...(Otros modelos se puede ver en la tienda web)		

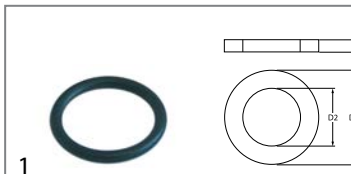

código	511512	referencia	3150410
descripción	junta tórica EPDM espesor 2.62mm int.ø 18.72mm UE 10 pzs		
Para modelos:	090BME, 091BME, L100, L40, L40S, L60, L80, PGA20, PGA30, PGA40, PGA60, PGA80, PGW20, PGW30, PGW40, PGW60, PGW80		

código	504561	referencia	3151080
descripción	junta tórica EPDM espesor 2.62mm int.ø 29.82mm UE 1 pzs		
Para modelos:	091FR1E, 091FR1EA, 091FR1ED, 091FR1G, 091FR1GD, 091FR1I, 091FR1IA, 091FR1ID, 091FR1ID-VERS.052012, 091FR1I-VERS.032012, 091FR7G, 091FR7G-VERS.052012, 0A1FR1E, 0A1FR1ED, 0A1FR1G, 0A1FR1GD, 0A1FR1GD-VERS.2004, 0A1FR1G-VERS.2004, 0B1FR1G, 0B1FR1GD, 0D1FR1E, 0D1FR1ED, 0D1FR1G, 0D1FR1GD, 0D1FR1GD-VERS.2004, 0D1FR1G-VERS.2004, 191FR2E, 191FR2ED, 191FR2G, 191FR2GD, 191FR2I, 191FR2ID, 191FR2ID-VERS.092012, 191FR2I-VERS.032012, 1A1FR2E, 1A1FR2ED, 1A1FR2G, 1A1FR2GD, 1A1FR2GD-VERS.2004, 1A1FR2G-VERS.2004, 1D1FR2ED, 1D1FR2G, 1D1FR2GD, 1D1FR2GD-VERS.2004, 1D1FR2G-VERS.2004, 70F1, 70F1B, 70FE1, 70FE1B, 71F2...(Otros modelos se puede ver en la tienda web)		

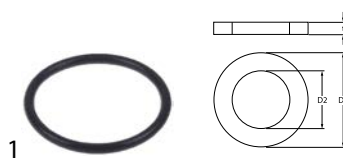

código	519179	referencia	3151930
descripción	junta tórica EPDM espesor 3.53mm int.ø 41.28mm UE 1 pzs		
Para modelos:	C165D, C165S, C165VD, C165VS, C207D, C207D-VERS.2006, C207S, C207S-VERS.2006, C207VD, C207VD-VERS.2006, C207VS, C207VS-VERS.2006, C304AD, C304AD-VERS.2006, C304AS, C304AS-VERS.2006, C304AVD, C304AVD-VERS.2006, C304AVS, C304AVS-VERS.2006, C304D, C304D-VERS.2006, C304S, C304S-VERS.2006, C304VD, C304VD-VERS.2006, C304VS, C304VS-VERS.2006, C92D-VERS.2006, C92S-VERS.2006, C92VD-VERS.2006, C92VS-VERS.2006, CS243D, CS243D-VERS.2006, CS243S, CS243S-VERS.2006, CS243VD, CS243VD-VERS.2006, CS243VS, CS243VS-VERS.2006, CS370AD, CS370AD-VERS.2006, CS370AS, CS370AS-VERS.2006, CS370AVD, CS370AVD-VERS.2006, CS370AVS, CS370AVS-VERS.2006, CS370D, CS370D-VERS.2006...(Otros modelos se puede ver en la tienda web)		

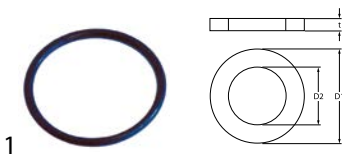

código	532064	referencia	3150140
descripción	junta tórica EPDM espesor 2.62mm int.ø 32.99mm UE 10 pzs		
Para modelos:	L100, L40, L40S, L60, L80		



código	532109	referencia	3150360
descripción	junta tórica EPDM espesor 3.53mm int.ø 42.86mm UE 10 pzs		

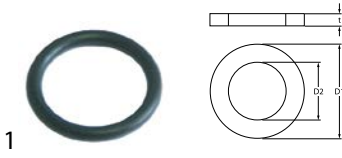

código	511518	referencia	3150520
descripción	junta tórica EPDM espesor 3.53mm int.ø 23.4mm UE 10 pzs		
Para modelos:	F60P, F60PR, F80PR, L45		



código	532114	referencia	3150240
descripción	junta tórica EPDM espesor 3.53mm int.ø 50.8mm UE 10 pzs		
Para modelos:	L100, L40, L40S, L60, L80		

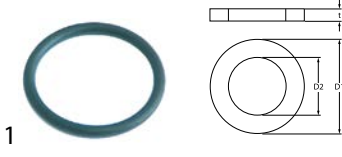

código	511524	referencia	3150260
descripción	junta tórica EPDM espesor 3.53mm int.ø 32.93mm UE 10 pzs		
Para modelos:	L100, L40, L40S, L60, L80		

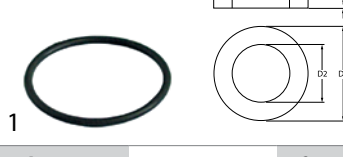

código	511331	referencia	3152390
descripción	junta tórica EPDM espesor 3.53mm int.ø 53.57mm UE 1 pzs		

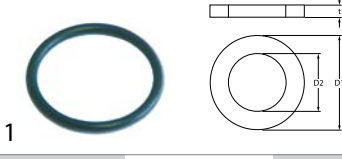

código	511526	referencia	3150010
descripción	junta tórica EPDM espesor 3.53mm int.ø 36.1mm UE 10 pzs		
Para modelos:	F60P, F60PR, F60T, F80P, F80PR, L40, L40S, L45, L60		



código	521120	referencia	3035850 3152160
descripción	junta tórica EPDM espesor 5.34mm int.ø 37.47mm UE 1 pzs		
Para modelos:	C165D, C165S, C165VD, C165VS, C207D, C207D-VERS.2006, C207S, C207S-VERS.2006, C207VD, C207VS, C304AD, C304AD-VERS.2006, C304AS, C304AS-VERS.2006, C304AVD, C304AVS, C304D, C304D-VERS.2006, C304S, C304S-VERS.2006, C304VD, C304VS, C92D-VERS.2006, C92S-VERS.2006, CS243D, CS243D-VERS.2006, CS243S, CS243S-VERS.2006, CS243VD, CS243VS, CS370AD, CS370AD-VERS.2006, CS370AS, CS370AS-VERS.2006, CS370AVD, CS370AVS, CS370D, CS370D-VERS.2006, CS370S, CS370S-VERS.2006, CS370VD, CS370VS, CS466AD, CS466AD-VERS.2006, CS466AS, CS466AS-VERS.2006, CS466AVD, CS466AVS, CS466D, CS466D-VERS.2006... (Otros modelos se puede ver en la tienda web)		



código	510408	referencia	3152650
descripción	junta tórica EPDM espesor 5.34mm int.ø 47mm UE 1 pzs		



código	510409	referencia	3150430 3151960 37Q5260
descripción	junta tórica EPDM espesor 5.34mm int.ø 56.52mm UE 1 pzs		
Para modelos:	091CP1E, 0A1CP1E, 0G1CP1E, 0G1CP1EC, 0G1CP1E-VERS.2004, 191PI2E, 191PI2EA, 1A1PI2E, 1A1PI2EA, 1D1PI2E, 1D1PI2EA, 1G1PI1E, 30CPSE, 31PIE6, 6040090, 6040310, 6043850, 6043980, 70CPE, 71PIE15, 71PIE15A, 90CPE, 91PIE15, 91PIE15A, F60P, F60PR, F60T, F80P, F80PR, KD100, KD100A, KD100PSD, KD130, KD130A, KD130E, KD130EAT, KD60, KD60E, KD60EAT, KD60M, KD60MA, KD60ME, KD60MPS, KD60MPSA, KD60PS, KD60PSD, KD6EATSD, KD85, KD85A, KD85E... (Otros modelos se puede ver en la tienda web)		

silicona



código	532521	referencia	3152370
descripción	junta tórica silicona espesor 1.78mm int.ø 34.65mm UE 1 pzs		
Para modelos:	04WFAAV, 08WFA4E, 08WFA4G, 08WFAAE, 08WFAAG, 08WFAAV, 090FAA, 0A0FA1, 0A0FA4, 0A0FAA, 0D0FA1, 0D0FA4, 0D0FAA, 0G0FA0, 12WFA6E, 12WFA6G, 12WFAAA, 12WFAAE, 12WFAAG, 12WFAAN, 190FA, 190FAA, 190FAB, 190FAD, 191FAAE, 191FAAG, 191FABG, 191FADG, 191FAE, 191FAG, 1A0FA1, 1A0FA2, 1A0FA4, 1A0FA5, 1A0FAA, 1A0FAB, 1A1FA1G, 1A1FA2G, 1A1FA4G, 1A1FA5G, 1A1FAAG, 1A1FABG, 1D0FA1, 1D0FA2, 1D0FA4, 1D0FA5, 1D0FAA, 1D0FAB, 1D1FA1G, 1D1FA2G... (Otros modelos se puede ver en la tienda web)		



código	532541	referencia	3152040
descripción	junta tórica silicona espesor 1.78mm int.ø 47.35mm UE 1 pzs		
Para modelos:	04WFAAV, 08WFA4E, 08WFA4G, 08WFAAE, 08WFAAG, 08WFAAV, 090FAA, 0A0FA1, 0A0FA4, 0A0FAA, 0D0FA1, 0D0FA4, 0D0FAA, 0G0FA0, 12WFA6E, 12WFA6G, 12WFAAA, 12WFAAE, 12WFAAG, 12WFAAN, 190FA, 190FAA, 190FAB, 190FAD, 191FAAE, 191FAAG, 191FABG, 191FADG, 191FAE, 191FAG, 1A0FA1, 1A0FA2, 1A0FA4, 1A0FA5, 1A0FAA, 1A0FAB, 1A1FA1G, 1A1FA2G, 1A1FA4G, 1A1FA5G, 1A1FAAG, 1A1FABG, 1D0FA1, 1D0FA2, 1D0FA4, 1D0FA5, 1D0FAA, 1D0FAB, 1D1FA1G, 1D1FA2G... (Otros modelos se puede ver en la tienda web)		



código	532520	referencia	3150390
descripción	junta tórica silicona espesor 2.62mm int.ø 15.08mm UE 1 pzs		
Para modelos:	030BME, 030FE, 031BME, 070BM, 070BME, 071BM, 071BME, 090BM, 090BME, 091BM, 091BME, 1A1PI1G, 1A1PI1GA, 1D1PI1G, 1D1PI1GA, 1G1PI1G, 30F, 30FES, 30FS, 31PI6, 70F, 70FE, 70FES, 71F, 71FE, 71PI10, 71PI10A, 91PI10, 91PI10A		



código	532519	referencia	3152331
descripción	junta tórica silicona espesor 5.34mm int.ø 53.34mm UE 1 pzs		
Para modelos:	191CP1GA, 191PD1G, 191PD2G, 191PI1G, 191PI1GA, 191PI2E, 191PI2EA, 191PI2G, 191PI2GA, 191PI2V, 191PI2VA, 1A1CP1GA, 1A1PD1G, 1A1PD2G, 1A1PI1G, 1A1PI1GA, 1A1PI2E, 1A1PI2EA, 1A1PI2G, 1A1PI2GA, 1A1PI2V, 1A1PI2VA, 1D1CP1GA, 1D1PD1G, 1D1PD2G, 1D1PI1G, 1D1PI1GA, 1D1PI2E, 1D1PI2EA, 1D1PI2G, 1D1PI2GA, 1D1PI2V, 1D1PI2VA, 1G1PD1G, 1G1PI1E, 1G1PI1G, 291PD3G, 291PI3E, 291PI3G, 2A1PD3G, 2A1PI3E, 2A1PI3G, 2D1PI3G, PV200, PV200A, PV300, PV300A		

Viton



código	532487	referencia	3150690
descripción	junta tórica Viton espesor 2.62mm int.ø 25.07mm UE 1 pzs		
Para modelos:	04WFR3ED, 06WFR3GD, 08WFR4ED, 091FE28, 091FE28B, 091FR3E, 091FR3ED, 091FR3G, 091FR3GD, 0A1FR3E, 0A1FR3ED, 0A1FR3G, 0A1FR3GD, 0D1FR3E, 0D1FR3ED, 0D1FR3G, 0D1FR3GD, 0G1FR3G, 0G1FR3GD, 0G1FR7G, 10WFR4GD, 191FR4E, 191FR4ED, 191FR4G, 191FR4GD, 1A1FR4E, 1A1FR4ED, 1A1FR4G, 1A1FR4GD, 1D1FR4E, 1D1FR4ED, 1D1FR4G, 1D1FR4GD, 1G1FR4G, 1G1FR4GD, 1G1FR8G, 30F1, 30F1B, 30FES2, 30FES2B, 30FS2, 30FS2B, 70FES2, 70FES2B, 90F110B, 91F210, 91F210B, FC1011G, FC1221G, FC611G... (Otros modelos se puede ver en la tienda web)		



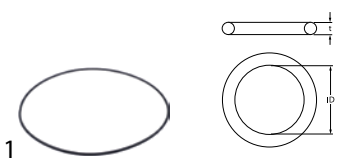

código	550494	referencia	3152150 3152151
descripción	junta tórica Viton espesor 3.53mm int.ø 47.22mm UE 1 pzs		
Para modelos:	0A1FR1E, 0A1FR1ED, 0D1FR1E, 0D1FR1ED, 1A1FR2E, 1A1FR2ED, 1D1FR2ED		

NBR

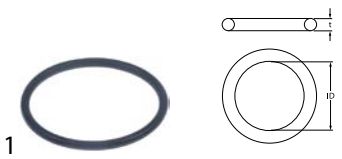

código	532609	referencia	3151750
descripción	junta tórica NBR espesor 7mm int.ø 387mm UE 1 pzs		
Para modelos:	LCV, P10, P102, P10M, P20, P202, P5		

HNBR



código	526272	referencia	3152151
descripción	junta tórica HNBR espesor 3.53mm int.ø 47.22mm UE 1 pzs		

anillos de junta

juntas de fibra



código	517173	referencia	37Q5130
descripción	junta plana FIBER ø ext. 14mm int.ø 8mm espesor 1.5mm UE 1 pzs		



código	506071	referencia	37Q2340
descripción	junta plana FIBER ø ext. 25mm int.ø 18mm espesor 2mm UE 1 pzs		



código	510123	referencia	37Q4070
descripción	junta plana FIBER ø ext. 60mm int.ø 46mm espesor 2mm UE 1 pzs		
Para modelos:	191PD1G, 191PD2G, 191PI1G, 191PI1GA, 191PI2E, 191PI2EA, 191PI2G, 191PI2GA, 191PI2V, 191PI2VA, 1A1PI2G, 1A1PI2GA, 1D1PI2G, 1D1PI2GA, MCF20, MCF40, PV200, PV200A, PV300, PV300A		



código	510405	referencia	N/A
descripción	junta plana fibra ø ext. 56mm int.ø 42mm espesor 2mm para rosca 1¼" UE 1 pzs		

juntas de goma



código	519383	referencia	3150290
descripción	junta goma ø ext. 110mm int.ø 83mm espesor 3mm UE 1 pzs		
Para modelos:	F60P, F60PR, F60T, F80P, F80PR, L45		



código	520054 ¹	referencia	3152480
descripción	junta plana goma ø ext. 23.5mm int.ø 14mm espesor 2.3mm UE 10 pzs		

¹UE 10 piezas





código	519114	referencia	3151890
descripción	junta plana goma ø ext. 25mm int.ø 16.5mm espesor 2mm UE 1 pzs		
Para modelos:	C165D, C165S, C165VD, C165VS, C207D, C207D-VERS.2006, C207S, C207S-VERS.2006, C207VD, C207VD-VERS.2006, C207VS, C207VS-VERS.2006, C304AD, C304AD-VERS.2006, C304AS, C304AS-VERS.2006, C304AVD, C304AVD-VERS.2006, C304AVS, C304AVS-VERS.2006, C304D, C304D-VERS.2006, C304S, C304S-VERS.2006, C304VD, C304VD-VERS.2006, C304VS, C304VS-VERS.2006, C92D-VERS.2006, C92S-VERS.2006, C92VD-VERS.2006, C92VS-VERS.2006, CS243D, CS243D-VERS.2006, CS243S, CS243S-VERS.2006, CS243VD, CS243VD-VERS.2006, CS243VS, CS243VS-VERS.2006, CS370AD, CS370AD-VERS.2006, CS370AS, CS370AS-VERS.2006, CS370AVD, CS370AVD-VERS.2006, CS370AVS, CS370AVS-VERS.2006, CS370D, CS370D-VERS.2006...(Otros modelos se puede ver en la tienda web)		

		
1		
código	507360	referencia 3150060
descripción	junta plana goma ø ext. 30mm int.ø 21mm espesor 2mm UE 1 pzs	
Para modelos:	L100, L80	

		
1		
código	519341	referencia 3151980
descripción	junta plana goma ø ext. 40mm int.ø 5.5mm espesor 2mm UE 1 pzs	
Para modelos:	C165D, C165S, C165VD, C165VS, C207D, C207D-VERS.2006, C207S, C207S-VERS.2006, C207VD, C207VD-VERS.2006, C207VS, C207VS-VERS.2006, C304AD, C304AD-VERS.2006, C304AS, C304AS-VERS.2006, C304AVD, C304AVD-VERS.2006, C304AVS, C304AVS-VERS.2006, C304D, C304D-VERS.2006, C304S, C304S-VERS.2006, C304VD, C304VD-VERS.2006, C304VS, C304VS-VERS.2006, C92D-VERS.2006, C92S-VERS.2006, C92VD-VERS.2006, C92VS-VERS.2006, CS243D, CS243D-VERS.2006, CS243S, CS243S-VERS.2006, CS243VD, CS243VD-VERS.2006, CS243VS, CS243VS-VERS.2006, CS370AD, CS370AD-VERS.2006, CS370AS, CS370AS-VERS.2006, CS370AVD, CS370AVD-VERS.2006, CS370AVS, CS370AVS-VERS.2006, CS370D, CS370D-VERS.2006...(Otros modelos se puede ver en la tienda web)	

		
1		
código	517181	referencia 3030160
descripción	junta plana goma ø ext. 44mm int.ø 32mm espesor 3mm UE 1 pzs	
Para modelos:	KD37, KD40, LP202, LP202HC, LP302, LP302HC, LP402, LP402HC, LP402V, N100D, N100S, N100VD, N100VS, N38D, N38S, N38VD, N38VS, N42D, N42S, N42VD, N42VS, N50D, N50S, N50VD, N50VS, N66D, N66S, N66VD, N66VS, N70D, N70S, N70VD, N70VS, N85D, N85S, N85VD, N85VS	

		
1		
código	511435	referencia 37Q3420
descripción	junta plana goma ø ext. 47mm int.ø 39mm espesor 2mm UE 1 pzs	

		
1		
código	519117	referencia 37Q4220
descripción	junta plana goma ø ext. 60mm int.ø 47mm espesor 3mm UE 1 pzs	

		
1		
código	519118	referencia 37Q4190
descripción	junta plana goma ø ext. 70mm int.ø 52mm espesor 3mm UE 1 pzs	
Para modelos:	LF50, LF50E, LF50EM, LF50EMPS, LF50EMPS-VERS.122012, LF50EM-VERS.122012, LF50E-VERS.122012, LF50E-VERS.2007, LP70	

		
1		
código	511318	referencia 37Q1580
descripción	junta plana goma ø ext. 75mm int.ø 59mm espesor 2mm UE 1 pzs	
Para modelos:	KSV25P, KSV325P	

		
1		
código	510680	referencia 37Q4210
descripción	junta plana goma ø ext. 82mm int.ø 62mm espesor 2mm UE 1 pzs	
Para modelos:	LC100, LC100-VERS.2001, LC130, LC130-VERS.2001	

		
1		
código	505405	referencia 3045960
descripción	junta plana NBR ø ext. 58mm int.ø 40mm espesor 3mm vaciado	
Para modelos:	BX101E, BX101E-VERS.122013, BX101G, BX101G-VERS.122013, BX122E, BX122E-VERS.122013, BX122G, BX122G-VERS.122013, BX61E, BX61E-VERS.122013, BX61G, BX61G-VERS.122013, BX82E, BX82E-VERS.122013, BX82G, BX82G-VERS.122013, FC1011E, FC1011G, FC1221E, FC1221G, FC611E, FC611G, FM1011E1, FM1011E1-VERS.2006, FM1011E2, FM1011E2-VERS.2006, FM1011E3, FM1011E3-VERS.2006, FM1011G1, FM1011G1-VERS.2006, FM1011G2, FM1011G2-VERS.2006, FM1011G3, FM1011G3-VERS.2006, FM1221E1, FM1221E1-VERS.2006, FM1221E2, FM1221E2-VERS.2006, FM1221E3, FM1221E3-VERS.2006, FM1221G1, FM1221G1-VERS.2006, FM1221G2, FM1221G2-VERS.2006, FM1221G3, FM1221G3-VERS.2006, FM2011E2-VERS.2006, FM2011E3-VERS.2006, FM2011G2-VERS.2006, FM2011G3-VERS.2006...(Otros modelos se puede ver en la tienda web)	

juntas de plástico

		
1		
código	504435	referencia 3152010
descripción	junta plana plástico ø ext. 18mm int.ø 9.5mm espesor 2.5mm para bisagra de puerta batiente UE 1 pzs	

juntas de cobre

DIN-7603-A

		
1		
código	506411	referencia 3151730
descripción	junta plana cobre ø ext. 32.9mm int.ø 27mm espesor 1.5mm	
Para modelos:	FC101, FC101E, FC241E, FC241G, FC61, FC61E, FCV101, FCV101-CSA, FCV101DM, FCV101DM-CSA, FCV101DS, FCV101DS-CSA, FCV101E, FCV101EDM, FCV101EDM-UL, FCV101EDS, FCV101EDS-UL, FCV101E-UL, FCV141, FCV141-CSA, FCV141DM, FCV141DM-CSA, FCV141DS, FCV141DS-CSA, FCV141E, FCV141EDM, FCV141EDS, FCV241E, FCV241EDM, FCV241EDM-UL, FCV241EDS, FCV241EDS-UL, FCV241E-UL, FCV241G, FCV241G-CSA, FCV241GDM, FCV241GDM-CSA, FCV241GDS, FCV241GDS-CSA, FCV3EM, FCV401DM, FCV401DM-CSA, FCV401EDM, FCV401EDM-UL, FCV4E, FCV4EDS, FCV4EM, FCV61, FCV61-CSA, FCV61DM...(Otros modelos se puede ver en la tienda web)	

juntas de silicona



código	694916	referencia	36E3320
descripción	junta silicona ø ext. 45mm int.ø 34mm espesor 5mm		
Para modelos:	BX101E, BX101E-VERS.122013, BX101G, BX101G-VERS.122013, BX122E, BX122E-VERS.122013, BX122G, BX122G-VERS.122013, BX61E, BX61E-VERS.122013, BX61G, BX61G-VERS.122013, BX82E, BX82E-VERS.122013, BX82G, BX82G-VERS.122013, FC1011E, FC1011G, FC1221E, FC1221G, FC611E, FC611G, FM1011E1, FM1011E1-VERS.2006, FM1011E2, FM1011E2-VERS.2006, FM1011E3, FM1011E3-VERS.2006, FM1011G1, FM1011G1-VERS.2006, FM1011G2, FM1011G2-VERS.2006, FM1011G3, FM1011G3-VERS.2006, FM1221E1, FM1221E1-VERS.2006, FM1221E2, FM1221E2-VERS.2006, FM1221E3, FM1221E3-VERS.2006, FM1221G1, FM1221G1-VERS.2006, FM1221G2, FM1221G2-VERS.2006, FM1221G3, FM1221G3-VERS.2006, FM2011E2-VERS.2006, FM2011E3-VERS.2006, FM2011G2-VERS.2006, FM2011G3-VERS.2006...(Otros modelos se puede ver en la tienda web)		



código	698207	referencia	3FL1137
descripción	junta radial int.ø 30mm ø ext. 40mm espesor 7mm		

juntas especiales

para hornos a vapor combinado



código	699497	referencia	3332580
descripción	junta ø ext. 92.5mm int.ø 51mm grafito espesor 2mm		

juntas de gomaespuma



código	901678	referencia	3022960
descripción	junta de gomaespuma UE 1200mm incl. adhesivo para tapa		
Para modelos:	DP10		



código	696776	referencia	36E3780
descripción	junta para intercambiador térmico L 50mm An 50mm brida int.ø 34mm espesor 1mm dist. del agujero 40mm		
Para modelos:	FM1011G1, FM1011G2, FM1011G3, FM1221G1, FM1221G2, FM1221G3, FM2021G1, FM2021G2, FM2021G3, FM611G1, FM611G2, FM611G3, FM721G1, FM721G2, FM721G3		

juntas de árbol

juntas de árbol



código	520473	referencia	3004400
descripción	junta		
Para modelos:	FC1011E, FC1011G, FC1221E, FC1221G, FC611E, FC611G, FM1011E1, FM1011E1-VERS.2006, FM1011E2, FM1011E2-VERS.2006, FM1011E3, FM1011E3-VERS.2006, FM1011G1, FM1011G1-VERS.2006, FM1011G2, FM1011G2-VERS.2006, FM1011G3, FM1011G3-VERS.2006, FM1221E1, FM1221E1-VERS.2006, FM1221E2, FM1221E2-VERS.2006, FM1221E3, FM1221E3-VERS.2006, FM1221G1, FM1221G1-VERS.2006, FM1221G2, FM1221G2-VERS.2006, FM1221G3, FM1221G3-VERS.2006, FM2011E2-VERS.2006, FM2011E3-VERS.2006, FM2011G2-VERS.2006, FM2011G3-VERS.2006, FM2021E1, FM2021E2, FM2021E2-VERS.2006, FM2021E3, FM2021E3-VERS.2006, FM2021G1, FM2021G2, FM2021G2-VERS.2006, FM2021G3, FM2021G3-VERS.2006, FM611E1, FM611E1-VERS.2006, FM611E2, FM611E2-VERS.2006, FM611E3, FM611E3-VERS.2006...(Otros modelos se puede ver en la tienda web)		



código	696779	referencia	36E3400
descripción	junta para intercambiador térmico L 60mm An 60mm brida int.ø 34mm espesor 3mm dist. del agujero 40mm		
Para modelos:	FC1011G, FC1221G, FC611G, FM1011G1, FM1011G1-VERS.2006, FM1011G2, FM1011G2-VERS.2006, FM1011G3, FM1011G3-VERS.2006, FM1221G1, FM1221G1-VERS.2006, FM1221G2, FM1221G2-VERS.2006, FM1221G3, FM1221G3-VERS.2006, FM2011G2-VERS.2006, FM2011G3-VERS.2006, FM2021G1, FM2021G2, FM2021G2-VERS.2006, FM2021G3, FM2021G3-VERS.2006, FM611G1, FM611G1-VERS.2006, FM611G2, FM611G2-VERS.2006, FM611G3, FM611G3-VERS.2006, FM721G1, FM721G1-VERS.2006, FM721G2, FM721G2-VERS.2006, FM721G3, FM721G3-VERS.2006		



código	550685	referencia	3151670
descripción	junta radial int.ø 12mm ø ext. 32mm espesor 7mm		
Para modelos:	FCV3EM, FCV4E, FCV4EDS, FCV4EM		



código	505405	referencia	3045960
descripción	junta plana NBR ø ext. 58mm int.ø 40mm espesor 3mm vaciado		
Para modelos:	BX101E, BX101E-VERS.122013, BX101G, BX101G-VERS.122013, BX122E, BX122E-VERS.122013, BX122G, BX122G-VERS.122013, BX61E, BX61E-VERS.122013, BX61G, BX61G-VERS.122013, BX82E, BX82E-VERS.122013, BX82G, BX82G-VERS.122013, FC1011E, FC1011G, FC1221E, FC1221G, FC611E, FC611G, FM1011E1, FM1011E1-VERS.2006, FM1011E2, FM1011E2-VERS.2006, FM1011E3, FM1011E3-VERS.2006, FM1011G1, FM1011G1-VERS.2006, FM1011G2, FM1011G2-VERS.2006, FM1011G3, FM1011G3-VERS.2006, FM1221E1, FM1221E1-VERS.2006, FM1221E2, FM1221E2-VERS.2006, FM1221E3, FM1221E3-VERS.2006, FM1221G1, FM1221G1-VERS.2006, FM1221G2, FM1221G2-VERS.2006, FM1221G3, FM1221G3-VERS.2006, FM2011E2-VERS.2006, FM2011E3-VERS.2006, FM2011G2-VERS.2006, FM2011G3-VERS.2006...(Otros modelos se puede ver en la tienda web)		



código	541499	referencia	3151450
descripción	junta para ANGELO PO tamaño 1¼"		
Para modelos:	FC101, FC1011E, FC1011G, FC101E, FC1221E, FC1221G, FC241, FC241E, FC241G, FC61, FC611E, FC611G, FC61E, FCV101, FCV101-CSA, FCV101DM, FCV101DM-CSA, FCV101DS, FCV101DS-CSA, FCV101E, FCV101EDM, FCV101EDM-UL, FCV101EDS, FCV101EDS-UL, FCV101E-UL, FCV141, FCV141-CSA, FCV141DM, FCV141DM-CSA, FCV141DS, FCV141DS-CSA, FCV141E, FCV141EDM, FCV141EDS, FCV241, FCV241DM, FCV241DS, FCV241E, FCV241EDM, FCV241EDM-UL, FCV241EDS, FCV241EDS-UL, FCV241E-UL, FCV241G, FCV241G-CSA, FCV241GDM, FCV241GDM-CSA, FCV241GDS, FCV241GDS-CSA, FCV401DM...(Otros modelos se puede ver en la tienda web)		

juntas de puerta para lavavajillas

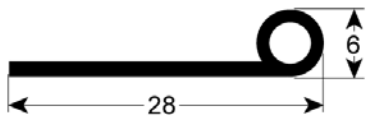

código	518234	referencia	37Q3910
descripción	junta de puerta L 450mm An 28mm H 6mm UE 1 con 5 orificios		
Para modelos:	LT10R, LT20F, LT25F		



código	519385	referencia	3150220
descripción	junta para sensor de temperatura al corazón ø ext. 8mm int.ø 4mm espesor 5mm		
Para modelos:	FCV101DM, FCV101DM-CSA, FCV101DS, FCV101DS-CSA, FCV101EDM, FCV101EDM-UL, FCV101EDS, FCV101EDS-UL, FCV141DM, FCV141DM-CSA, FCV141DS, FCV141DS-CSA, FCV141EDM, FCV141EDS, FCV241DM, FCV241DS, FCV241EDM, FCV241EDM-UL, FCV241EDS, FCV241EDS-UL, FCV241GDM, FCV241GDM-CSA, FCV241GDS, FCV241GDS-CSA, FCV401DM, FCV401DM-CSA, FCV401EDM, FCV401EDM-UL, FCV4EDS, FCV61DM, FCV61DM-CSA, FCV61DS, FCV61DS-CSA, FCV61EDM, FCV61EDM-UL, FCV61EDS, FCV61EDS-UL, FCV72EDM-UL, FCV72EDS-UL, FM1011E2, FM1011E3, FM1011G2, FM1011G3, FM1221E2, FM1221E3, FM1221G2, FM1221G3, FM2021E2, FM2021E3, FM2021G2...(Otros modelos se puede ver en la tienda web)		

otros



código	510847	referencia	N/A
descripción	junta dosificación de abrillantador int.ø 22mm ø ext. 32mm altura exterior 5mm		



código	901678	referencia	3022960
descripción	junta de gomaespuma UE 1200mm incl. adhesivo para tapa		
Para modelos:	DP10		



código	519384	referencia	3150880
descripción	junta espesor 3mm agujero ø 40mm medidas 100x100mm		



código	900854	referencia	37Q4440
descripción	junta para hornos L 332mm An 128mm lana mineral		
Para modelos:	FPZ14E, FPZ16E, FPZ24E, FPZ2635E, FPZ26E, FPZ4G, FPZ6G		



juntas de termostato



1

código	550492	referencia	3152240
descripción	junta para termostato		
Para modelos:	04WBMEV, 04WCP1EM, 04WVT1IV, 04WVT1IV-VERS.022010, 04WVT2IV, 04WVT2IV-VERS.022010, 04WVT3RV, 06WBR3E, 06WCP1GM, 06WFT1EV, 06WFT2EV, 06WFT3EV, 06WFT4EV, 06WFT6EV, 06WFT7EV, 08WCP1GM, 08WFA4E, 08WFAAE, 08WFT1EV, 08WFT2EV, 08WFT3EV, 08WFT4EV, 08WFT6EV, 08WFT7EV, 08WVT1IV, 08WVT1IV-VERS.112009, 08WVT2IV, 08WVT2IV-VERS.112009, 090FT1E, 090FT2E, 090FT4E, 090FT5E, 090FT7E, 090PE4, 090VT1I, 090VT1I-VERS.112010, 090VT1W, 090VT1W-VERS.102008, 090VTR, 091CP1E, 091FR1E, 091FR1ED, 091FR1G, 091FR1GD, 091FR1I, 091FR1I-VERS.032012, 091FR3ED, 091FR3G, 091FR3GD, 091FR7G... (Otros modelos se puede ver en la tienda web)		



1

código	510167	referencia	3150270 315Q270
descripción	junta para termostato ø ext. 41mm int.ø 18mm UE ANGELO PO/ ZANUSSI pzs núm. Ref. 3150270/66717		
Para modelos:	030BME, 031BME		

juntas patra brazos de lavado



1

código	519445	referencia	3150230
descripción	junta D1 ø 80mm D2 ø 50mm espesor 3mm con 4 orificios roscados		
Para modelos:	F60P, F60PR, F60T, F80P, F80PR, FCV61EDS, FCV61EDS-UL, L45, LF50E, LF50EM, LF50EMPS, LF50EMPS-VERS.122012, LF50EM-VERS.122012, LF50E-VERS.122012, LF50E-VERS.2007, LP70		

componentes para el circuito frigorífico

válvulas

válvulas de expansión

DANFOSS

válvulas

tipo TS2/TES2



1

código	750304	referencia	33A0870
descripción	válvula de expansion DANFOSS tipo TES2 refrigerante R404a/ R507 acodado 90° controlado por termostato entrada 3/8" SAE salida 12mm conexión para soldadura compensación presión 6mm conexión para soldadura p máx. 34bar -40 a +10°C capilar 1500mm		
Para modelos:	ART2LD, ART2SD, ART3SD, GR4A-0NR01, IA101L, IA101S, IA72S, XA101L, XA101S, XA72S		



1

código	750520	referencia	33A0500
descripción	válvula de expansion DANFOSS tipo TES2 refrigerante R404a/R507 acodado 90° entrada 3/8" SAE salida 12mm conexión para soldadura compensación presión 6mm conexión para soldadura p máx. 34bar capilar 1500mm		
Para modelos:	IS102S, IS102SR, IS102SR-0NR01, IS102SW, SM2L, SM2LR, SM2LW, SM2S, SM2SR, SM2SW, SM3S, SM3SR, SM4SR		

filtros deshidratadores antiácidos

otros



1

código	750177	referencia	33A0180
descripción	deshidratador ø 24mm L 155mm empalme 6,3/6,3mm		
Para modelos:	120, 120NN, 120PV, 135, 135-4, 135A, 135BN, 135BNX, 135CPX, 135NN, 135NNX, 135PVX, 135X, 135X-3, 135X-4, 135XE, 3G6SA, 3G6SA2, 3G6SA4, 40, 40-OPR01, 40B, 40B-OPR01, 40BX-OPR01, 40CP, 40CP-OPR01, 40CPX, 40CPX-OPR01, 40EV, 40EV-OPR01, 40EVP, 40PL, 40PV, 40PV-OPR01, 40X, 40X-OPR01, 40XPV, 4G6SB, 4G6SB2, 4G6SB4, 4G6SB6, 55, 55B, 55PV, 65, 65A, 65B, 65BA, 65BX, 65BX-2...(Otros modelos se puede ver en la tienda web)		



código	750058	referencia	33A1150
descripción	deshidratador ø 24mm L 158mm empalme 3,1/6,3mm		
Para modelos:	120PV, 55, 55PV, TVRV		

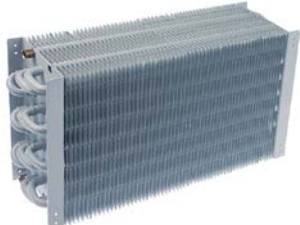

código	750230	referencia	34D3390
descripción	evaporador L 360mm An 110mm H 200mm		
Para modelos:	6BEA11A, 6BEA11B, 6BEA11M, 6BEA2A, 6BEA2B, 6BEA2M, 6BEA3A, 6BEA3B, 6BEA3M, 6BEAA, 6BEAB, 6BEAM, 6BMA11A, 6BMA11B, 6BMA11M, 6BMA2A, 6BMA2B, 6BMA2M, 6BMA3A, 6BMA3B, 6BMA3M, 6BMAA, 6BMAB, 6BMAM, 6RMA2A, 6RMA2B, 6RMA2M, 6RMAZ, 6RMAA, 6RMAB, 6RMAM, 6RMAZ, 6RMB2A, 6RMB2B, 6RMB2M, 6RMB2Z, 6RMB4A, 6RMB4B, 6RMB4M, 6RMB4Z, 6RMB4A, 6RMBB, 6RMBM, 6RMBZ, BE1A, BE1A-11, BE1A-2, BE1A-3, BM1A, BM1A-11... (Otros modelos se puede ver en la tienda web)		

evaporadores para frigoríficos

específico del fabricante



código	750248	referencia	34E0640
descripción	evaporador completo con ventilador		
Para modelos:	MX120, MX130, MX140, MX150		

código	750118	referencia	34D4260
descripción	evaporador L 410mm An 90mm H 130mm		
Para modelos:	CX120NN, CX130NN, CX140BN, CX140CP, CX140NN, CX150BN, CX150CP, CX150NN, CX55, CX60, CX65, CX652, CX65NB, CX65NCP, CX65NN, CX65PV, CX70, CX702, CX70NB, CX70NN, CX70PV, CX70R, ISFEN, S60, S60-2, S60E, S60X, S60X-2		

código	750049	referencia	34D0360
descripción	evaporador L 1340mm An 430mm H 5mm tipo		
Para modelos:	120, 120NN, 120PV, 55, 55PV		



código	750658	referencia	34E2930
descripción	evaporador L 415mm An 105mm H 330mm		
Para modelos:	6EB, 6EB11, 6EB11A, 6EB11M, 6EB13, 6EB13A, 6EB13M, 6EB2, 6EB22, 6EB22A, 6EB22M, 6EB2A, 6EB2M, 6EB4, 6EB4A, 6EB4M, 6EBA, 6EBM, 6EC, 6EC11, 6EC11A, 6EC11M, 6EC13, 6EC13A, 6EC13M, 6EC2, 6EC22, 6EC22A, 6EC22M, 6EC2A, 6EC2M, 6EC4, 6EC4A, 6EC4M, 6ECA, 6ECM, 6ERB, 6ERB2, 6ERB2A, 6ERB2M, 6ERB4, 6ERB4A, 6ERB4M, 6ERBA, 6ERBM, 6ERC, 6ERC2, 6ERC2A, 6ERC2M, 6ERC4... (Otros modelos se puede ver en la tienda web)		



código	750247	referencia	32Z3420
descripción	evaporador L 255mm H 255mm An 50mm		
Para modelos:	6BEA11A, 6BEA11B, 6BEA11M, 6BEA11Z, 6BEA2A, 6BEA2B, 6BEA2M, 6BEA2Z, 6BEA3A, 6BEA3B, 6BEA3M, 6BEA3Z, 6BEAA, 6BEAB, 6BEAM, 6BEAZ, 6BEB11A, 6BEB11B, 6BEB11M, 6BEB11Z, 6BEB22A, 6BEB22B, 6BEB22M, 6BEB22Z, 6BEB2A, 6BEB2B, 6BEB2M, 6BEB2Z, 6BEB3A, 6BEB3B, 6BEB3M, 6BEB3Z, 6BEB4A, 6BEB4B, 6BEB4M, 6BEB4Z, 6BEBA, 6BEBB, 6BEBM, 6BEBZ, 6BMA11A, 6BMA11B, 6BMA11M, 6BMA11Z, 6BMA2A, 6BMA2B, 6BMA2M, 6BMA2Z, 6BMA3A, 6BMA3B... (Otros modelos se puede ver en la tienda web)		



código	750069	referencia	34D7670
descripción	evaporador L 420mm An 47mm H 300mm		
Para modelos:	6JA, 6JA2, 6JA2A, 6JA2M, 6JAA, 6JAM, 6JB, 6JB2, 6JB2A, 6JB2M, 6JB4A, 6JB4M, 6JBA, 6JBM		

código	750247	referencia	32Z3420
descripción	evaporador L 255mm H 255mm An 50mm		
Para modelos:	6BEA11A, 6BEA11B, 6BEA11M, 6BEA11Z, 6BEA2A, 6BEA2B, 6BEA2M, 6BEA2Z, 6BEA3A, 6BEA3B, 6BEA3M, 6BEA3Z, 6BEAA, 6BEAB, 6BEAM, 6BEAZ, 6BEB11A, 6BEB11B, 6BEB11M, 6BEB11Z, 6BEB22A, 6BEB22B, 6BEB22M, 6BEB22Z, 6BEB2A, 6BEB2B, 6BEB2M, 6BEB2Z, 6BEB3A, 6BEB3B, 6BEB3M, 6BEB3Z, 6BEB4A, 6BEB4B, 6BEB4M, 6BEB4Z, 6BEBA, 6BEBB, 6BEBM, 6BEBZ, 6BMA11A, 6BMA11B, 6BMA11M, 6BMA11Z, 6BMA2A, 6BMA2B, 6BMA2M, 6BMA2Z, 6BMA3A, 6BMA3B... (Otros modelos se puede ver en la tienda web)		



código	750069	referencia	34D7670
descripción	evaporador L 420mm An 47mm H 300mm		
Para modelos:	6JA, 6JA2, 6JA2A, 6JA2M, 6JAA, 6JAM, 6JB, 6JB2, 6JB2A, 6JB2M, 6JB4A, 6JB4M, 6JBA, 6JBM		

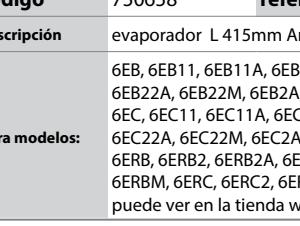

código	750069	referencia	34D7670
descripción	evaporador L 420mm An 47mm H 300mm		
Para modelos:	6JA, 6JA2, 6JA2A, 6JA2M, 6JAA, 6JAM, 6JB, 6JB2, 6JB2A, 6JB2M, 6JB4A, 6JB4M, 6JBA, 6JBM		

código	750069	referencia	34D7670
descripción	evaporador L 420mm An 47mm H 300mm		
Para modelos:	6JA, 6JA2, 6JA2A, 6JA2M, 6JAA, 6JAM, 6JB, 6JB2, 6JB2A, 6JB2M, 6JB4A, 6JB4M, 6JBA, 6JBM		



código	750069	referencia	34D7670
descripción	evaporador L 420mm An 47mm H 300mm		
Para modelos:	6JA, 6JA2, 6JA2A, 6JA2M, 6JAA, 6JAM, 6JB, 6JB2, 6JB2A, 6JB2M, 6JB4A, 6JB4M, 6JBA, 6JBM		



1

código	750000	referencia	34D4300
descripción	evaporador L 730mm An 90mm H 130mm		
Para modelos:	CX120, CX130, CX140, CX140PV, CX150, CX150PV, CX150R, S125, S125-4, S125E, S125X, S125X-4		

condensadores



1

código	605131	referencia	34D4831
descripción	condensador An 260mm P 110mm H 260mm		
Para modelos:	135XE, 55B, 65BA, 65BXE, CX60B, DS31, DS31A, DS31C, DS31M, FX70B, MX60B, MX70B, S125, S125X, S600B, S600B2, S600BE, S60BE, SM03LT7, SM03LT7A, SM03LT7M, SP120BN, SP55B, VS31, VS31M		



1

código	750543	referencia	34d6180
descripción	condensador An 275mm P 100mm H 260mm		
Para modelos:	135BN, 135BNX, 135CPX, 55, 55PV, 65, 65A, 65PVX, 65X, 65X-2, 65XE, 6FMB11A, 6FMB11B, 6FMB11M, 6FMB11Z, 6FMB2A, 6FMB2B, 6FMB2M, 6FMB2Z, 6FMB4A, 6FMB4B, 6FMB4M, 6FMB4Z, 6FMB4, 6FMBB, 6FMBM, 6FMBZ, 6FMC11A, 6FMC11B, 6FMC11M, 6FMC11Z, 6FMC2A, 6FMC2B, 6FMC2M, 6FMC2Z, 6FMC4A, 6FMC4B, 6FMC4M, 6FMC4Z, 6FMC4, 6FMCB, 6FMC, 6FMCZ, 6JB, 6JB2, 6JB2A, 6JB2M, 6JB4A, 6JB4M, 6JBA...(Otros modelos se puede ver en la tienda web)		

bandejas de agua condensada y cubetas de evaporación

bandejas de agua condensada



1

código	750716	referencia	36Z0300
descripción	bandeja de agua condensada L 610mm An 295mm H 50mm		
Para modelos:	120, 120B, 120NN, 120PV, 135, 135-4, 135A, 135B, 135BA, 135BN, 135BNX, 135BX, 135BXE, 135BXR, 135CPX, 135NN, 135NNX, 135PVX, 135X, 135X-3, 135X-4, 135XE, 135XR, 55, 55B, 55PV, 65, 65A, 65B, 65BA, 65BX, 65BX-2, 65BXE, 65BXR, 65NB, 65NBX, 65NN, 65NNX, 65PVX, 65X, 65X-2, 65XE, 65XR, 6FMA11A, 6FMA11B, 6FMA11M, 6FMA11Z, 6FMA2A, 6FMA2B, 6FMA2M...(Otros modelos se puede ver en la tienda web)		

otros



1

código	750059	referencia	36Z6471
descripción	bandeja de agua condensada para condensador L 440mm An 357mm		
Para modelos:	135BN, 135BNX, 65B, 65BA, 65BX, 65BX-2, 65BXE, 65BXR, SP135BN, SP65B		

técnica de accionamiento y rodamientos de bolas

correas de accionamiento

correas trapezoidales nervadas

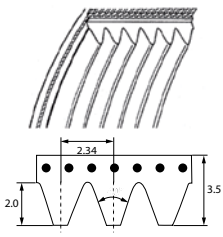

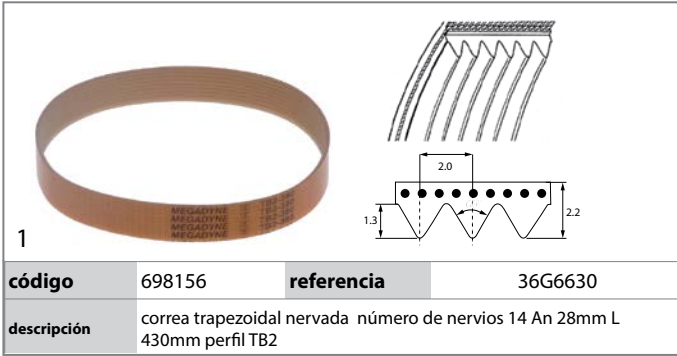

1

código	692144	referencia	36G6610
descripción	correa trapezoidal nervada número de nervios 12 An 28mm L 559mm perfil J		
Para modelos:	LCV, P10, P102, P10M, P20, P202, P5, TV1, TV1M, TV2L		

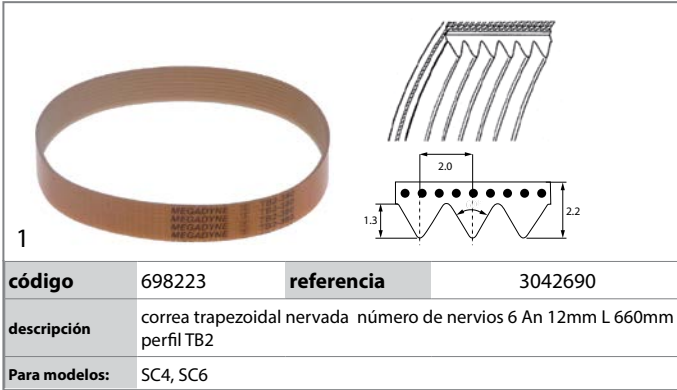

código	698156	referencia	36G6630
descripción	correa trapezoidal nervada número de nervios 14 An 28mm L 430mm perfil TB2		



código	698223	referencia	3042690
descripción	correa trapezoidal nervada número de nervios 6 An 12mm L 660mm perfil TB2		
Para modelos:	SC4, SC6		

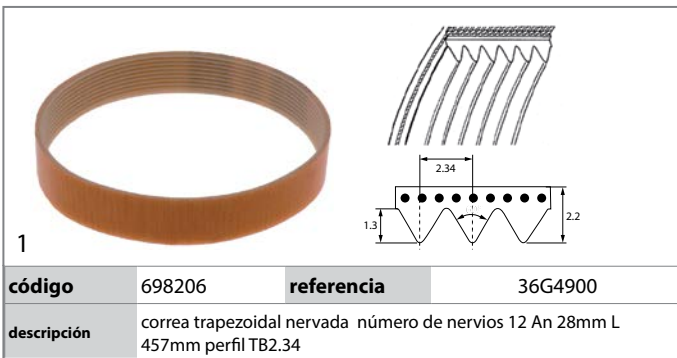

código	698206	referencia	36G4900
descripción	correa trapezoidal nervada número de nervios 12 An 28mm L 457mm perfil TB2.34		

muelles

muelles de torsión

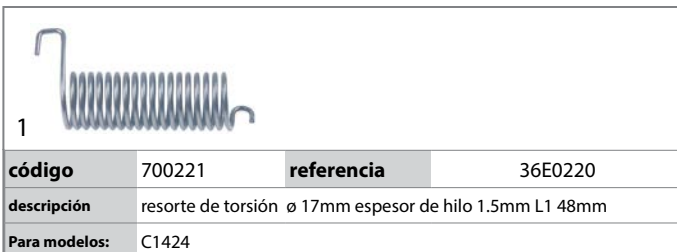

código	700221	referencia	36E0220
descripción	resorte de torsión ϕ 17mm espesor de hilo 1.5mm L1 48mm		
Para modelos:	C1424		

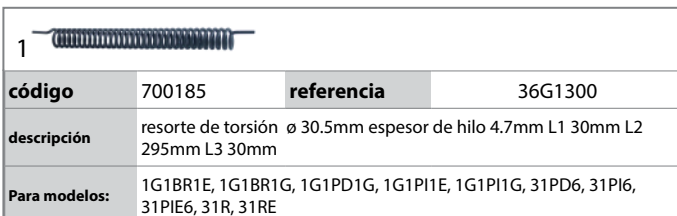

código	700185	referencia	36G1300
descripción	resorte de torsión ϕ 30.5mm espesor de hilo 4.7mm L1 30mm L2 295mm L3 30mm		
Para modelos:	1G1BR1E, 1G1BR1G, 1G1PD1G, 1G1PI1E, 1G1PI1G, 31PD6, 31PI6, 31PIE6, 31R, 31RE		



código	700186	referencia	36G2640
descripción	resorte de torsión ϕ 31.7mm espesor de hilo 5.5mm L1 30mm L2 300mm L3 30mm		
Para modelos:	191PD1G, 191PD2G, 191PI1G, 191PI1GA, 191PI2E, 191PI2EA, 191PI2G, 191PI2GA, 191PI2V, 191PI2VA, 1A1PD1G, 1A1PD2G, 1A1PI1G, 1A1PI1GA, 1A1PI2E, 1A1PI2EA, 1A1PI2G, 1A1PI2GA, 1A1PI2V, 1A1PI2VA, 1D1PD1G, 1D1PD2G, 1D1PI1G, 1D1PI1GA, 1D1PI2E, 1D1PI2EA, 1D1PI2G, 1D1PI2GA, 1D1PI2V, 1D1PI2VA, 71AR, 71ARE, 71PD10, 71PD15, 71PI10, 71PI10A, 71PIE15, 71PIE15A, 71PV15, 71PV15A, 71RA, 91AR, 91ARE, 91PI10, 91PI10A, 91PIE15, 91PIE15A, 91RA		



código	691182	referencia	36G9970
descripción	resorte de torsión ϕ 52mm espesor de hilo 6mm L1 110mm L2 30mm L3 30mm UE 2 pzs		
Para modelos:	PV200A, PV300		

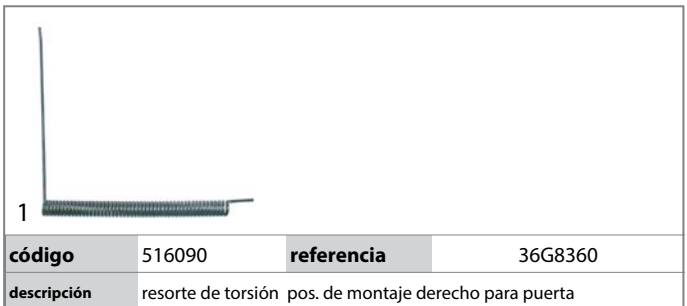

código	516090	referencia	36G8360
descripción	resorte de torsión pos. de montaje derecho para puerta		

resortes de compresión

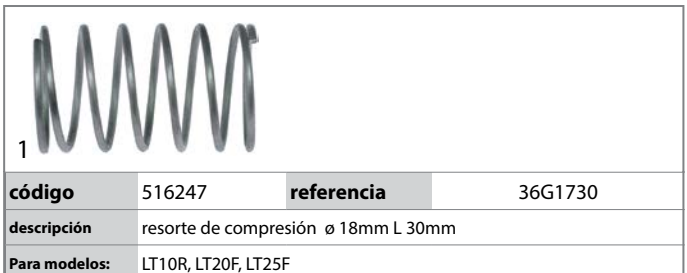

código	516247	referencia	36G1730
descripción	resorte de compresión ϕ 18mm L 30mm		
Para modelos:	LT10R, LT20F, LT25F		

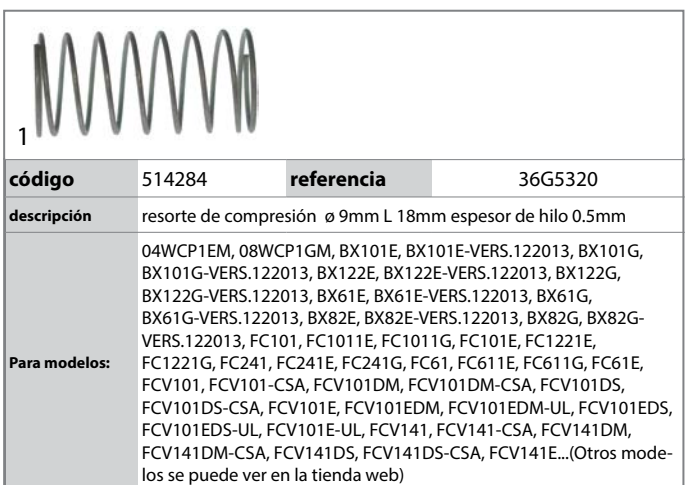

código	514284	referencia	36G5320
descripción	resorte de compresión ϕ 9mm L 18mm espesor de hilo 0.5mm		
Para modelos:	04WCP1EM, 08WCP1GM, BX101E, BX101E-VERS.122013, BX101G, BX101G-VERS.122013, BX122E, BX122E-VERS.122013, BX122G, BX122G-VERS.122013, BX61E, BX61E-VERS.122013, BX61G, BX61G-VERS.122013, BX82E, BX82E-VERS.122013, BX82G, BX82G-VERS.122013, FC101, FC101E, FC101G, FC101E, FC1221E, FC1221G, FC241, FC241E, FC241G, FC61, FC61E, FC61G, FC61E, FCV101, FCV101-CSA, FCV101DM, FCV101DM-CSA, FCV101DS, FCV101DS-CSA, FCV101E, FCV101EDM, FCV101EDM-UL, FCV101EDS, FCV101EDS-UL, FCV101E-UL, FCV141, FCV141-CSA, FCV141DM, FCV141DM-CSA, FCV141DS, FCV141DS-CSA, FCV141E...(Otros modelos se puede ver en la tienda web)		



resortes enrollados

resortes enrollados



1

código	517338	referencia	36G7650
descripción	resorte enrollado		
Para modelos:	N303D, N303S, N303VD, N303VS, N354D, N354S, N354VD, N354VS, N506D, N506S, N506VD, N506VS, N607D, N607S, N607VD, N607VS, N760D, N760S, N760VD, N760VS, N886D, N886S, N886VD, N886VS		



1

código	519340	referencia	36G8430
descripción	resorte enrollado		
Para modelos:	LP124, LP124S-VERS.052006, LP124V, LP124-VERS.052006, LP124VS-VERS.052006, LP124V-VERS.052006		

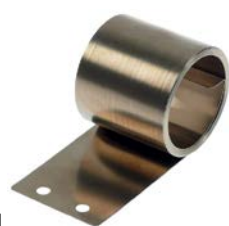

1

código	519616	referencia	36G8740
descripción	resorte enrollado An 40mm int.ø 36mm longitud de lengüeta 50mm		
Para modelos:	C165D, C165S, C165VD, C165VS, C207D, C207D-VERS.2006, C207S, C207S-VERS.2006, C207VD, C207VD-VERS.2006, C207VS, C207VS-VERS.2006, C304AD, C304AD-VERS.2006, C304AS, C304AS-VERS.2006, C304AVD, C304AVD-VERS.2006, C304AVS, C304AVS-VERS.2006, C304D, C304D-VERS.2006, C304S, C304S-VERS.2006, C304VD, C304VD-VERS.2006, C304VS, C304VS-VERS.2006, C92D-VERS.2006, C92S-VERS.2006, C92VD-VERS.2006, C92VS-VERS.2006, CS243D, CS243D-VERS.2006, CS243S, CS243S-VERS.2006, CS243VD, CS243VD-VERS.2006, CS243VS, CS243VS-VERS.2006, CS370AD, CS370AD-VERS.2006, CS370AS, CS370AS-VERS.2006, CS370AVD, CS370AVD-VERS.2006, CS370AVS, CS370AVS-VERS.2006, CS370D, CS370D-VERS.2006...(Otros modelos se puede ver en la tienda web)		



1

código	519619	referencia	36G8750
descripción	resorte enrollado con soporte An 40mm int.ø 36.5mm longitud de lengüeta 60mm distancia de sujeción 18mm taladro ø 5mm		
Para modelos:	C207D-VERS.2006, C207S-VERS.2006, C207VD-VERS.2006, C207VS-VERS.2006, C304AD, C304AD-VERS.2006, C304AS, C304AS-VERS.2006, C304AVD, C304AVD-VERS.2006, C304AVS, C304AVS-VERS.2006, C304D, C304D-VERS.2006, C304S, C304S-VERS.2006, C304VD, C304VD-VERS.2006, C304VS, C304VS-VERS.2006, C92D-VERS.2006, C92S-VERS.2006, C92VD-VERS.2006, C92VS-VERS.2006, CS243D, CS243D-VERS.2006, CS243S, CS243S-VERS.2006, CS243VD, CS243VD-VERS.2006, CS243VS, CS243VS-VERS.2006, CS370AD, CS370AD-VERS.2006, CS370AS, CS370AS-VERS.2006, CS370AVD, CS370AVD-VERS.2006, CS370AVS, CS370AVS-VERS.2006, CS370D, CS370D-VERS.2006, CS370S, CS370S-VERS.2006, CS370VD, CS370VD-VERS.2006, CS370VS, CS370VS-VERS.2006, CS466AD, CS466AD-VERS.2006, CS466AS...(Otros modelos se puede ver en la tienda web)		

amortiguadores



1

código	691188	referencia	36G1370
descripción	amortiguador		

resortes de tracción



1

código	505501	referencia	36G1340
descripción	muelle de tracción ø 11mm espesor de hilo 1.5mm L 220mm		
Para modelos:	F60P, F60PR, F60T, F80P, F80PR, L45		



1

código	501296	referencia	36H1430
descripción	muelle de tracción ø 12mm longitud total 275mm espesor de hilo 1.6mm		





1

código	700718	referencia	36G5240
descripción	muelle de tracción ø 16.4mm longitud total 79.2mm espesor de hilo 2.9mm		
Para modelos:	0A1CP1E, 0A1CP1G, 0A1FR1E, 0A1FR1ED, 0A1FR1G, 0A1FR1GD, 0A1FR1GD-VERS.2004, 0A1FR1G-VERS.2004, 0A1FR3G, 0A1FR3GD, 0B1CP1G, 0B1FR1G, 0B1FR1GD, 0D1CP1E, 0D1CP1G, 0D1FR1E, 0D1FR1ED, 0D1FR1G, 0D1FR1GD, 0D1FR1GD-VERS.2004, 0D1FR1G-VERS.2004, 0D1FR3G, 0D1FR3GD, 1A1CP1G, 1A1CP2G, 1A1FR2E, 1A1FR2ED, 1A1FR2G, 1A1FR2GD, 1A1FR2GD-VERS.2004, 1A1FR2G-VERS.2004, 1A1FR4G, 1A1FR4GD, 1D1CP1G, 1D1CP2G, 1D1FR2ED, 1D1FR2G, 1D1FR2GD, 1D1FR2GD-VERS.2004, 1D1FR2G-VERS.2004, 1D1FR4G, 1D1FR4GD, 30CPS, 30CPSE, 30F1, 30F1B, 30FES2, 30FES2B, 30FS2, 30FS2B...(Otros modelos se puede ver en la tienda web)		

			
código	517286	referencia	36H1460
descripción	muelle de tracción ø 35mm longitud total 865mm espesor de hilo 5mm		
Para modelos:	KD100, KD100A, KD100PSD, KD130, KD130A, KD130E, KD130EAT		

			
código	519163	referencia	36G8870
descripción	muelle de tracción ø 38.5mm longitud total 394mm espesor de hilo 6.5mm para campana		
Para modelos:	LC100, LC100-VERS.2001, LC130, LC130-VERS.2001, LC80		

			
código	541334	referencia	32V0940
descripción	manómetro ø 60mm margen de presión 0 a 1bar rosca 1/8" marca 0.5 marmita empalme lado posterior		
Para modelos:	1A1PI1G, 1A1PI1GA, 1A1PI2E, 1A1PI2EA, 1A1PI2G, 1A1PI2GA, 1A1PI2V, 1A1PI2VA, 1D1PI1G, 1D1PI1GA, 1D1PI2E, 1D1PI2EA, 1D1PI2G, 1D1PI2GA, 1D1PI2V, 1D1PI2VA, 2A1PI3G, 2D1PI3G		

			
código	541062	referencia	32Z0060
descripción	manómetro ø 63mm margen de presión 0 a 1bar empalme marca ajustable marmita rosca 1/4"		
Para modelos:	191PI1G, 191PI1GA, 191PI2E, 191PI2EA, 191PI2G, 191PI2GA, 191PI2V, 191PI2VA, 1A1PI1G, 1A1PI1GA, 1A1PI2E, 1A1PI2EA, 1A1PI2V, 1A1PI2VA, 1D1PI1G, 1D1PI1GA, 1D1PI2E, 1D1PI2EA, 1D1PI2V, 1D1PI2VA, 1G1PI1E, 1G1PI1G, 291PI3E, 291PI3G, 2A1PI3E, 31PI6, 31PIE6, 71PI10, 71PI10A, 71PIE15, 71PIE15A, 71PV15, 71PV15A, 91PI10, 91PI10A, 91PIE15, 91PIE15A, BPV2, PV200, PV200A, PV300, PV300A		
repuestos para	541062	código	541130
		referencia	—
		vidrio ø 58mm espesor 2mm	

accesorios de cocina

gastro-norm

piezas de unión

			
código	691173	referencia	35S6320
descripción	distanciador para recipiente gastronorm L1 175mm L2 155mm inox An 25mm H 15mm UE 1 pzs		
Para modelos:	SA87		

manómetros

			
código	541508	referencia	33D1680
descripción	manómetro ø 40mm margen de presión 0-4bar empalme rosca 1/8"		
Para modelos:	BX101E, BX101E-VERS.122013, BX101G, BX101G-VERS.122013, BX122E, BX122E-VERS.122013, BX122G, BX122G-VERS.122013, BX61E, BX61E-VERS.122013, BX61G, BX61G-VERS.122013, BX82E, BX82E-VERS.122013, BX82G, BX82G-VERS.122013, FCV101, FCV101-CSA, FCV101DM, FCV101DM-CSA, FCV101DS, FCV101DS-CSA, FCV101E, FCV101EDM, FCV101EDM-UL, FCV101EDS, FCV101EDS-UL, FCV101E-UL, FCV141, FCV141-CSA, FCV141DM, FCV141DM-CSA, FCV141DS, FCV141DS-CSA, FCV141E, FCV141EDM, FCV141EDS, FCV241, FCV241DM, FCV241DS, FCV241E, FCV241EDM, FCV241EDM-UL, FCV241EDS, FCV241EDS-UL, FCV241E-UL, FCV241G, FCV241G-CSA, FCV241GDM, FCV241GDM-CSA...(Otros modelos se puede ver en la tienda web)		

			
código	541880	referencia	33D1680-old
descripción	manómetro ø 41mm margen de presión 0-6bar rosca 1/8" 0-90PSI		

enrolladores de tubo y duchas de mano para lavado

duchas de mano para lavado

			
código	691048	referencia	33D1700
descripción	ducha de mano de aparato 1/2" M L 225mm tipo STAR		
repuestos para	691048	código	507309
		referencia	—
		junta tórica EPDM espesor 2.62mm int.ø 17.13mm UE 1 pzs	
		código	510322
		referencia	—
		código	524055
		referencia	—
		junta plana goma ø ext. 18mm int.ø 12mm espesor 2mm UE 1 pzs	
		código	528485
		referencia	—
		junta tórica EPDM espesor 1.78mm int.ø 6.07mm UE 1 pzs	

Continúa en la página siguiente



repuestos para	691048			
	código	528494	referencia	—
	junta goma ø ext. 13mm int.ø 4mm espesor 4mm UE 1 pzs			

accesorios para	361028			
	código	520091	referencia	—
	tubo de nylon int.ø 4mm ø ext. 6mm L 2m grosor de la pared 1mm p de trabajo 10bar p de reventamiento 50bar T máx 100°C transparente			

	código	542068	referencia	33D1700
1	descripción ducha de mano de aparato 1/2" H L 219mm con anilla de amarre tipo KLARCO			

SEKO				
piezas de repuesto				
	código	362021	referencia	3186560
1	descripción tubo flexible para bomba SEKO tubo ø 6x10mm tubo Santoprene			
Para modelos:	FX101E3, FX101E3C, FX101E3C-VERS.022014, FX101E3R, FX101E3R-VERS.022014, FX101E3-VERS.022014, FX101G3, FX101G3C, FX101G3C-VERS.022014, FX101G3R, FX101G3R-VERS.022014, FX101G3-VERS.022014, FX10E3CR, FX10E3CR-VERS.022014, FX10G3CR, FX10G3CR-VERS.022014, FX122E3, FX122E3C, FX122E3T, FX122E3T-VERS.022014, FX122G3, FX122G3C, FX122G3T, FX122G3T-VERS.022014, FX12E3CT, FX12E3CT-VERS.022014, FX12G3CT, FX12G3CT-VERS.022014, FX201E3, FX201E3P, FX201E3P-VERS.022014, FX201E3-VERS.022014, FX201G3P, FX201G3-VERS.022014, FX202E3, FX202E3-230V-3-50Hz-60Hz, FX202E3-230V-3-50Hz-60Hz-VERS.022014, FX202E3-VERS.022014, FX202G3, FX202G3-VERS.022014, FX61E3, FX61E3C, FX61E3CR, FX61E3CR-VERS.022014, FX61E3C-VERS.022014, FX61E3R, FX61E3R-VERS.022014, FX61E3-VERS.022014, FX61G3, FX61G3C... (Otros modelos se puede ver en la tienda web)			

	código	540675	referencia	3212740 3FL0182
1	descripción cabezal de ducha			





dosificadores

bombas dosificadoras

BORES

versión empotrada

con regulación de cantidad

	código	361028	referencia	33D0750
1	descripción dosificador BORES regulación de caudal 0.39l/h 230VAC abrillantador tubo ø 4x6mm tubo silicona tipo Perios versión empotrada con válvula de retención integrada CODE P1B			
Para modelos:	F60PR, F60T, F80P, F80PR			
repuestos para	361028			
	código	361127	referencia	—
	tubo flexible para bomba Perios abrillantador tubo ø 3x6mm tipo de tubo silicona L 120mm			
	código	361464	referencia	—
	enrollador manguera abrillantador/detergente tipo de tubo Santoprene/Silikon tipo bomba Perios			
accesorios para	361028			
	código	361142	referencia	—
	kit de montaje detergente tipo de tubo 4x6mm longitud de tubo 2m PVC 2x tubo flexible/filtro recipiente/caño de pared transparente			
	código	520090	referencia	—
	tubo flexible de PVC int.ø 4mm ø ext. 6mm L 2m grosor de la pared 1mm T máx 60°C transparente			

bombas de pistón

piezas de repuesto

	código	361113	referencia	—
1	descripción bobina magnética 230VAC para tipo DB2			

	código	510298	referencia	N/A
1	descripción válvula labial dosificador apto para DB2/DS5			

bombas de membrana

dosificadoras eléctricas

Delta



1

código	361003	referencia	32Z1610
descripción	dosificador 220V abrillantador ciclo de trabajo 25% tipo EL-1 válvula labial		
repuestos para	361003		
	código	361122	referencia —
	válvula labial tipo DELTA		
	código	361123	referencia —
	membrana tipo DELTA		
	código	361169	referencia —
	empalme de tubo tipo DELTA		
	código	361188	referencia —
	arandela tipo DELTA		
	código	361319	referencia —
	junta plana goma int.ø 9mm ø ext. 14.5mm espesor 1mm tipo DELTA		

piezas de repuesto



1

código	361169	referencia	—
descripción	empalme de tubo tipo DELTA		



1









código	361123	referencia	—
descripción	membrana tipo DELTA		

autoaspirantes

LARGO



1

código	361575	referencia	33D2300
descripción	dosificador tipo N6 abrillantador empalme presión ø recto, 4x6mm conector para succión ø acodado, 6mm LANG		
repuestos para	361575		
	código	361079	referencia —
	resorte para tipo N5/N6 para esfera		
	código	361080	referencia —
	junta tórica EPDM espesor 2mm int.ø 16mm UE 1 pzs		
	código	361085	referencia —
	junta tórica EPDM espesor 2mm int.ø 8mm UE 1 pzs		
	código	361309	referencia —
	esfera para tipo N5/N6		
	código	361310	referencia —
	soporte para tipo N6 guía de bola		
	código	361311	referencia —
	junta tórica EPDM espesor 2mm int.ø 6mm UE 1 pzs para tipo N6		
	código	361314	referencia —
	anillo de válvula para tipo N6 soporte para junta tórica		
	código	361317	referencia —
	disco de obturación para tipo N6		
	código	361886	referencia —
	válvula de retención entradamm salidamm salida ø 12.4mm L 12.7mm		





accesorios			
 <p>1</p>			
código	101286	referencia	36Q0020
descripción	anillo cortante int.ø 6mm UE 1 pzs		
Para modelos:	04WFAAV, 08WFA4E, 08WFA4G, 08WFAAE, 08WFAAG, 08WFAAV, 090FAA, 0A0FA1, 0A0FA4, 0A0FAA, 0D0FA1, 0D0FA4, 0D0FAA, 0G0FA0, 12WFA6E, 12WFA6G, 12WFAAA, 12WFAAE, 12WFAAG, 12WFAAN, 190FA, 190FAA, 190FAB, 190FAD, 191FAAE, 191FAAG, 191FABG, 191FADG, 191FAE, 191FAG, 1A0FA1, 1A0FA2, 1A0FA4, 1A0FA5, 1A0FAA, 1A0FAB, 1A1FA1G, 1A1FA2G, 1A1FA4G, 1A1FA5G, 1A1FAAG, 1A1FABG, 1D0FA1, 1D0FA2, 1D0FA4, 1D0FA5, 1D0FAA, 1D0FAB, 1D1FA1G, 1D1FA2G...(Otros modelos se puede ver en la tienda web)		
accesorios para	101286		
 <p>código 100909 referencia 36Q0060</p> <p>tornillo de racor rosca M10x1 para tuboø 6mm UE 1 pzs</p>			
 <p>código 101464 referencia —</p> <p>tuerca de racor rosca M12x1 para ø de tubo 6mm</p>			

diversos			
 <p>1</p>			
código	361002	referencia	33D0060 33D0061
descripción	dosificador abrillantador entrada 6x8mm salida 4x6mm empalme presión ø 4x6mm conector para succión ø 6x8mm		
Para modelos:	F60P, L100, L40, L40S, L45, L60, L80		
repuestos para	361002		
 <p>código 510297 referencia N/A</p> <p>membrana para dosificadoras ø ext. 83mm espesor 1mm dosificador núm. Ref. 630614 para COMENDA</p>			
 <p>código 510298 referencia N/A</p> <p>válvula labial dosificador apto para DB2/DS5</p>			
 <p>código 510299 referencia N/A</p> <p>empalme de tubo para dosificadoras</p>			
 <p>código 510338 referencia N/A</p> <p>tuerca de racor dosificador rosca 1/2" ø 32mm H 15mm para dosificadoras</p>			
 <p>código 510847 referencia N/A</p> <p>junta dosificación de abrillantador int.ø 22mm ø ext. 32mm altura exterior 5mm</p>			
 <p>código 510870 referencia N/A</p> <p>soporte filtro para dosificadoras</p>			
 <p>código 510916 referencia N/A</p> <p>filtro para dosificadoras</p>			

piezas de repuesto			
 <p>1</p>			
código	510916	referencia	N/A
descripción	filtro para dosificadoras		

 <p>1</p>			
código	510847	referencia	N/A
descripción	junta dosificación de abrillantador int.ø 22mm ø ext. 32mm altura exterior 5mm		

 <p>1</p>			
código	510297	referencia	N/A
descripción	membrana para dosificadoras ø ext. 83mm espesor 1mm dosificador núm. Ref. 630614 para COMENDA		

 <p>1</p>			
código	510870	referencia	N/A
descripción	soporte filtro para dosificadoras		

 <p>1</p>			
código	510338	referencia	N/A
descripción	tuerca de racor dosificador rosca 1/2" ø 32mm H 15mm para dosificadoras		

 <p>1</p>			
código	510298	referencia	N/A
descripción	válvula labial dosificador apto para DB2/DS5		

autoaspirantes con presión secundaria

DIHR



código	361744	referencia	33D3240
descripción	dosificador tipo DW con empuje de presión secundaria abridor entrada 4mm salida 8mm conector para succión ø 4mm presión secundaria 10mm		
Para modelos:	KD100, KD100A, KD100PSD, KD130E, KD130EAT, KD37, KD40, KD40E-PSD, KD40LEPS, KD40LSPS, KD40LUX, KD40LUXE, KD40-VERS.112009, KD60, KD60M, KD60MA, KD60MPS, KD60MPSA, KD60PS, KD60PSD, KD85, KD85A, KD85E, KD85EA, KD85EAT, KD85EATS, KD85EPS, KD85E-PSA, KD85PS, KD85PSA, KN1100, KN1100SD, KN11PSDD, KN35, KN37, KN37PS, KN40, KN40PS, KN40PSD, KN50, KN50M, KN50MPS, KN50PS, KN50PSD, KN50PSDD, KN80, KN800, KN800PSD, KN80PS, LP70		
repuestos para	361744		
	código	520026	referencia —
	tubo flexible de PVC int.ø 4mm ø ext. 6mm L 10m grosor de la pared 1mm T máx 60°C transparente		
	código	520090	referencia —
	tubo flexible de PVC int.ø 4mm ø ext. 6mm L 2m grosor de la pared 1mm T máx 60°C transparente		

ELETTOBAR



código	510298	referencia	N/A
descripción	válvula labial dosificador apto para DB2/DS5		

GERMAC

piezas de repuesto



código	510298	referencia	N/A
descripción	válvula labial dosificador apto para DB2/DS5		

accesorios



código	361829	referencia	—
descripción	filtro de recipiente completo plástico tubo ø 5mm		

racores de tubo flexible

metal



código	361507	referencia	3016150
descripción	racor tubular acodado latón niquelado rosca 1/4" tubo ø 6/8mm UE 1 pzs		



código	361506	referencia	3014470
descripción	racor tubular acodado latón niquelado rosca 1/8" tubo ø 6/8mm UE 1 pzs		

Para modelos:	FM1011E2-VERS.2006, FM1011E3, FM1011E3-VERS.2006, FM1011G2-VERS.2006, FM1011G3, FM1011G3-VERS.2006, FM1221E2-VERS.2006, FM1221E3, FM1221E3-VERS.2006, FM1221G2-VERS.2006, FM1221G3, FM1221G3-VERS.2006, FM2011E2-VERS.2006, FM2011E3-VERS.2006, FM2011G2-VERS.2006, FM2011G3-VERS.2006, FM2021E2-VERS.2006, FM2021E3-VERS.2006, FM2021G2-VERS.2006, FM2021G3-VERS.2006, FM423E2, FM611E2-VERS.2006, FM611E3, FM611E3-VERS.2006, FM611G2-VERS.2006, FM611G3, FM611G3-VERS.2006, FM721E2-VERS.2006, FM721E3, FM721E3-VERS.2006, FM721G2-VERS.2006, FM721G3, FM721G3-VERS.2006, FX101E2, FX101E2C, FX101E2C-VERS.032014, FX101E2R, FX101E2R-VERS.032014, FX101E2-VERS.032014, FX101E3, FX101E3C, FX101E3C-VERS.022014, FX101E3R, FX101E3R-VERS.022014, FX101E3-VERS.022014, FX101G2, FX101G2C, FX101G2C-VERS.032014, FX101G2R, FX101G2R-VERS.032014...(Otros modelos se puede ver en la tienda web)		
----------------------	--	--	--



código	361182	referencia	3117580
descripción	tuerca rosca 1/4" H 5mm latón niquelado EC 17 UE 1 pzs		
Para modelos:	L100, L40, L40S, L60, L80, P5		

piezas T

sin válvula de retención



código	516082	referencia	35Z1090
descripción	pieza T plástico tubo ø 12-7-12mm 3 vías tubo ø 12-7-12mmmm		



código	519217	referencia	33Q3070
descripción	pieza T plástico tubo ø 12-9-12mm 3 vías tubo ø 12-9-12mm		
Para modelos:	F60P, L45, LC100, LC100-VERS.2001, LC130, LC130-VERS.2001, LC80, LF50		

código	530574	referencia	3033760
descripción	manguera de desagüe DN31 L 2000mm A ø interno 31mm A ø externo 35mm B ø interno 40mm B ø externo 46mm tubo ø ext. 38mm		
Para modelos:	KD85EATS, KD85EPS, KD85EPSA		

tubos flexibles

tubos flexibles de entrada

tubos flexibles de entrada de PVC

código	520010	referencia	33M0350
descripción	tubo flexible de entrada PVC recto-curvado DN13 empalmes 3/4" L 1500mm p de trabajo 10bar p de reventamiento 32bar T máx 90°C azul homologación VDE cierre plana		
accesorios para	520010		
	código	520053	referencia
			—
			filtro empalme 3/4" D1 ø 26mm D2 ø 15mm UE 10 pzs goma espesor 8mm
	código	520054	referencia
			3152480
			junta plana goma ø ext. 23.5mm int.ø 14mm espesor 2.3mm UE 10 pzs

código	519272	referencia	3029590 36U0730
descripción	manguera de desagüe DN24 L 1500mm ø int. recta 32mm ø ext. recto 35mm dim.ext. codo 40mm ø ext. codo 46mm tubo ø ext. 38mm		
Para modelos:	LC100, LC100-VERS.2001, LC130, LC130-VERS.2001, LC80, LF50, LF50E, LF50EM, LF50EMPS-VERS.122012, LF50EM-VERS.122012, LF50E-VERS.122012, LP70		

tubos flexibles industriales

tubos Niplaflex

código	530561	referencia	111AA05 131AA12 131AA14 131AA16
descripción	tubo de presión int.ø 10mm ø ext. 17mm L 5m grosor de la pared 3.5mm p de trabajo 10bar p de reventamiento 30bar T máx 110°C		
Para modelos:	04WBMEV, 04WCP1EM, 06WCP1GM, 06WFR3GD, 08WCP1GM, 08WGREV, 090BM1E, 090BM1G, 091CP1E, 091CP1G, 0G1CP1EC, 0G1CP1E-VERS.2004, 0G1CP1G-VERS.2004, 10CP1EA, 10CP1GA, 10CP1IA, 10WFR4GD, 12CP1EA, 12CP1GA, 12CP1IA, 18CP2EA, 18CP2GA, 18CP2IA, 190BM2E, 190BM2G, 190GRE, 191BR1E, 191BR1G, 191BR1GA, 191BR2E, 191BR2EA, 191BR2G, 191BR2GA, 191CP1G, 191CP2G, 1G0GRE, 1G1CP1G-VERS.2004, 1G1CP2G-VERS.2004, 291BR1E, 291BR1G, 291BR1GA, 291BR2E, 291BR2EA, 291BR2G, 291BR2GA, 6040090, 6040110, 6040310, 6042610, 6042630...(Otros modelos se puede ver en la tienda web)		

tubos de salida

código	530608	referencia	33M1660
descripción	manguera de desagüe DN24 L 1500mm A ø interno 24mm A ø externo 28mm B ø interno 28mm B ø externo 35mm tubo ø ext. 29mm resis.a la temp. 90°C		
Para modelos:	KD100, KD100A, KD100PSD, KD40, KD40EPSD, KD40LEPS, KD40L-SPS, KD40PS, KD60, KD60E, KD60EAT, KD60M, KD60MA, KD60ME, KD60MPS, KD60MPSA, KD60PS, KD60PSD, KD6EATSD, KN1100, KN1100SD, KN11PSDD, KN35, KN37PS, KN40PS, KN50MPS, KN50PS, KN50PSD, KN50PSDD, KN800, KN800PSD, KN80PS, N100D, N100S, N100VD, N100VS, N38D, N38S, N38VD, N38VS, N42D, N42S, N42VD, N42VS, N50D, N50S, N50VD, N50VS, N66D, N66S...(Otros modelos se puede ver en la tienda web)		

tubos de presostato

código	530560	referencia	111AA04
descripción	tubo de presostato int.ø 5mm ø ext. 9mm L 5m p de trabajo 30bar p de reventamiento 90bar resis.a la temp. 60°C		

tubos flexibles PU



código	512475	referencia	3003920
descripción	tubo flexible de dosificación ø ext. 8mm int.ø 6mm poliuretano azul UE al metro		
Para modelos:	FM1011E3, FM1011E3-VERS.2006, FM1011G3, FM1011G3-VERS.2006, FM1221E3, FM1221E3-VERS.2006, FM1221G3-VERS.2006, FM2011E3-VERS.2006, FM2011G3-VERS.2006, FM2021E3, FM2021E3-VERS.2006, FM2021G3, FM2021G3-VERS.2006, FM611E3, FM611E3-VERS.2006, FM611G3, FM611G3-VERS.2006, FM721E3, FM721E3-VERS.2006, FM721G3, FM721G3-VERS.2006, FX101E3, FX101E3C, FX101E3C-VERS.022014, FX101E3R, FX101E3R-VERS.022014, FX101E3-VERS.022014, FX101G3, FX101G3C, FX101G3C-VERS.022014, FX101G3R, FX101G3R-VERS.022014, FX101G3-VERS.022014, FX10E3CR, FX10E3CR-VERS.022014, FX10G3CR, FX10G3CR-VERS.022014, FX122E3, FX122E3C, FX122E3T, FX122E3T-VERS.022014, FX122G3, FX122G3C, FX122G3T, FX122G3T-VERS.022014, FX12E3CT, FX12E3CT-VERS.022014, FX12G3CT, FX12G3CT-VERS.022014, FX201E3...(Otros modelos se puede ver en la tienda web)		



código	510677	referencia	3000290
descripción	tubo flexible de dosificación ø ext. 8mm int.ø 6mm poliuretano rojo UE al metro		
Para modelos:	FM1011E3, FM1011E3-VERS.2006, FM1011G3, FM1011G3-VERS.2006, FM1221E3, FM1221E3-VERS.2006, FM1221G3-VERS.2006, FM2011E3-VERS.2006, FM2011G3-VERS.2006, FM2021E3, FM2021E3-VERS.2006, FM2021G3, FM2021G3-VERS.2006, FM611E3, FM611E3-VERS.2006, FM611G3, FM611G3-VERS.2006, FM721E3, FM721E3-VERS.2006, FM721G3, FM721G3-VERS.2006, FX101E3, FX101E3C, FX101E3R, FX101G3, FX101G3C, FX101G3R, FX10E3CR, FX10G3CR, FX122E3, FX122E3C, FX122G3, FX122G3C, FX201E3, FX202E3, FX61E3, FX61E3C, FX61E3CR, FX61E3R, FX61G3, FX61G3C, FX61G3CR, FX61G3R, FX82E3, FX82E3C, FX82G3, FX82G3C		

tubos formados

recto



código	506412	referencia	111AA08
descripción	tubo formado lavavajillas recto ø tubo 60mm int. ø tubo 50mm		
Para modelos:	FM1221E1, FM1221E2, FM1221E3, FM1221G1, FM1221G2, FM1221G3, FM2021E1, FM2021E2, FM2021E3, FM2021G1, FM2021G2, FM2021G3, FM721E1, FM721E2, FM721E3, FM721G1, FM721G2, FM721G3, FX101E1, FX101E1R, FX101E2, FX101E2C, FX101E2R, FX101E3, FX101E3C, FX101E3R, FX101G1, FX101G1R, FX101G2, FX101G2C, FX101G2R, FX101G3, FX101G3C, FX101G3R, FX10E2CR, FX10E3CR, FX10G2CR, FX10G3CR, FX61E1, FX61E1R, FX61E2, FX61E2C, FX61E2CR, FX61E2R, FX61E3, FX61E3C, FX61E3CR, FX61E3R, FX61G1, FX61G1R...(Otros modelos se puede ver en la tienda web)		

forma L



código	519160	referencia	33M1260
descripción	tubo formado L 150mm sistemas de lavado L-Form núm. Ref. 903876 An 110mm int. ø tubo 40mm		
Para modelos:	LF50, LF50E, LF50EM, LP70		



código	519382	referencia	3300230
descripción	tubo formado sistemas de lavado L-Form int. ø tubo 44mm		
Para modelos:	F60P, F60PR, F60T, L45		



código	512384	referencia	32Z2810
descripción	tubo formado sistemas de lavado L-Form L2 100mm ø tubo 65mm int. ø tubo 45mm		



código	517228	referencia	3115800
descripción	tubo formado sistemas de lavado L-Form núm. Ref. 15032/A		
Para modelos:	KD130, KD130A, KD130E, KD130EAT		

con derivación



1

código	517361	referencia	3031860
descripción	tubo formado L 450mm goma UE 1		



1

código	517364	referencia	3031860
descripción	tubo formado ø ext. 58 D1 ø 50mm D2 ø 35mm L 455mm negro UE 1		
Para modelos:	KD130, KD130A, KD130E, KD130EAT		

forma S



1

código	510678	referencia	3300240
descripción	tubo formado ø tubo 48mm int. ø tubo 39mm L 235mm UE 1 forma S		
Para modelos:	F60P, F60PR, F60T, L45		

para lavavajillas

otros



1

código	530590	referencia	33M1310
descripción	tubo flexible ø ext. 15mm int.ø 8mm núm. Ref. 200117 UE al metro		

guarniciones, empalmes para mangueras y tubos

empalmes de tubos

sin racor



1

código	519216	referencia	36G9050
descripción	pieza T plástico tubo ø 12-12-12mm 3 vías		
Para modelos:	LC100, LC100-VERS.2001, LC130, LC130-VERS.2001, LC80, LF50, LF50E, LF50EM, LP70		



1

código	516082	referencia	35Z1090
descripción	pieza T plástico tubo ø 12-7-12mm 3 vías tubo ø 12-7-12mmmm		



1

código	519217	referencia	33Q3070
descripción	pieza T plástico tubo ø 12-9-12mm 3 vías tubo ø 12-9-12mmmm		
Para modelos:	F60P, L45, LC100, LC100-VERS.2001, LC130, LC130-VERS.2001, LC80, LF50		



1

código	519630	referencia	3008090
descripción	pieza T plástico tubo ø 6x6x6mm 3 vías		
Para modelos:	191CP1G, 1G1CP1G-VERS.2004, FM1011E3, FM1011E3-VERS.2006, FM1011G3, FM1011G3-VERS.2006, FM1221E3-VERS.2006, FM1221G3-VERS.2006, FM2011E3-VERS.2006, FM2011G3-VERS.2006, FM2021E3-VERS.2006, FM2021G3-VERS.2006, FM611E3, FM611E3-VERS.2006, FM611G3, FM611G3-VERS.2006, FM721E3-VERS.2006, FM721G3-VERS.2006		

guarniciones
boquillas dobles



1

código	520160	referencia	3005480
descripción	boquilla doble latón niquelado rosca 1/8" - 1/8" UE 1 pzs		



1

código	541504	referencia	33Q5880
descripción	boquilla doble rosca 1/2" - 1/2"		
Para modelos:	FC101, FC241G, FC61, FCV101, FCV101-CSA, FCV101DM, FCV101DM-CSA, FCV101DS, FCV101DS-CSA, FCV141-CSA, FCV141DM-CSA, FCV141DS-CSA, FCV241G, FCV241G-CSA, FCV241GDM, FCV241GDM-CSA, FCV241GDS, FCV241GDS-CSA, FCV401DM, FCV401DM-CSA, FCV61, FCV61-CSA, FCV61DM, FCV61DM-CSA, FCV61DS, FCV61DS-CSA		



1

código	520883	referencia	3020420
descripción	reducción Inox rosca 1" - 1¼" UE 1 pzs L1 15mm L2 7mm EC 50		
Para modelos:	KD100, KD100A, KD100PSD, N100D, N100S, N100VD, N100VS, N38D, N38S, N38VD, N38VS, N42D, N42S, N42VD, N42VS, N50D, N50S, N50VD, N50VS, N66D, N66S, N66VD, N66VS, N70D, N70S, N70VD, N70VS, N85D, N85S, N85VD, N85VS		

reducciones



1

código	520700	referencia	33Q5650
descripción	reducción rosca 3/4" H - 1/2" M latón		
Para modelos:	FCV101, FCV101-CSA, FCV101DM, FCV101DM-CSA, FCV101DS, FCV101DS-CSA, FCV101E, FCV101EDM, FCV101EDM-UL, FCV101EDS, FCV101EDS-UL, FCV101E-UL, FCV141, FCV141-CSA, FCV141DM, FCV141DM-CSA, FCV141DS, FCV141DS-CSA, FCV141E, FCV141EDM, FCV141EDS, FCV241, FCV241DM, FCV241DS, FCV241E, FCV241EDM, FCV241EDM-UL, FCV241EDS, FCV241EDS-UL, FCV241E-UL, FCV241G, FCV241G-CSA, FCV241GDM, FCV241GDM-CSA, FCV241GDS, FCV241GDS-CSA, FCV3EM, FCV401DM, FCV401DM-CSA, FCV401EDM, FCV401EDM-UL, FCV4E, FCV4EDS, FCV4EM, FCV61, FCV61-CSA, FCV61DM, FCV61DM-CSA, FCV61DS, FCV61DS-CSA...(Otros modelos se puede ver en la tienda web)		



1

código	520177	referencia	3040920
descripción	reducción rosca 1/4" M - 1/8" H latón niquelado longitud total 13mm EC 17		

piezas angulares



1

código	541924	referencia	33Q4790
descripción	pieza angular rosca 1/2" H - 1/2" H latón		
Para modelos:	C165D, C165S, C165VD, C165VS, C207D, C207S, C207VD, C207VD-VERS.2006, C207VS, C207VS-VERS.2006, C304AD, C304AS, C304AVD, C304AVD-VERS.2006, C304AVS, C304AVS-VERS.2006, C304D, C304S, C304VD, C304VD-VERS.2006, C304VS, C304VS-VERS.2006, C92VD-VERS.2006, C92VS-VERS.2006, CS243D, CS243S, CS243VD, CS243VD-VERS.2006, CS243VS, CS243VS-VERS.2006, CS370AD, CS370AS, CS370AVD, CS370AVD-VERS.2006, CS370AVS, CS370AVS-VERS.2006, CS370D, CS370S, CS370VD, CS370VD-VERS.2006, CS370VS, CS370VS-VERS.2006, CS466AD, CS466AS, CS466AVD, CS466AVD-VERS.2006, CS466AVS, CS466AVS-VERS.2006, CS466D, CS466S...(Otros modelos se puede ver en la tienda web)		



1			
código	541493	referencia	33Q3900
descripción	pieza angular rosca 1/2" H - 1/2" M latón cromado		
Para modelos:	1A1PI1G, 1A1PI1GA, 1A1PI2E, 1A1PI2EA, 1A1PI2V, 1A1PI2VA, 1D1PI1G, 1D1PI1GA, 1D1PI2E, 1D1PI2EA, 1D1PI2V, 1D1PI2VA, 2A1PI3G, 2D1PI3G		

1			
código	520821	referencia	33Q4360
descripción	pieza angular rosca 1/4" H - 1/4" H latón niquelado		
Para modelos:	LC100, LC100-VERS.2001, LC130, LC130-VERS.2001, LC80, LP124S-VERS.052006, LP124-VERS.052006, LP124VS-VERS.052006, LP124V-VERS.052006, LP84S-VERS.052006, LP84-VERS.052006, LP84VS-VERS.052006, LP84V-VERS.052006		

1			
código	520824	referencia	3003750
descripción	pieza angular rosca 1/8" M - 1/8" H latón niquelado		
Para modelos:	FM1011E3, FM1011G3, FM1221E3, FM1221G3, FM2021E3, FM2021G3, FM611E3, FM611G3		

1			
código	541496	referencia	33Q5280
descripción	pieza angular rosca 1/2" M - 3/4" H fundición zincada		

1			
código	541494	referencia	33Q0600
descripción	pieza angular rosca 3/4" M - 3/4" H fundición zincada		
Para modelos:	ACBM, ACBM218, ANBM, ANBM218, ANBM75, L100, L80, SE14VB, SE21VB, SI14VB, SI21VB, SL14CVB, SL14NVB, SL21CVB, SL21NVB, SL7NVB, TBM, TBM218		

1			
código	541492	referencia	33Q0570
descripción	pieza angular H 1/2" M 1/2"		
Para modelos:	FCV3EM, FCV4E, FCV4EDS, FCV4EM, FM1011E3, FM1011G3, FM1221E3, FM1221G3, FM423E1, FM423E2, FM611E3, FM611G3, FM721E3, FM721G3, L100, L40S, L80, PIER06HD, PIER15HD		

piezas T

latón niquelado

1			
código	520385	referencia	3003770
descripción	pieza T rosca 1/8" H - 1/8" H - 1/8" H latón niquelado L 35mm		
Para modelos:	FM1011E3, FM1011G3, FM1221E3, FM611E3, FM611G3, FM721E3, FM721G3		

piezas Y

1			
código	521197	referencia	36E4290
descripción	pieza Y rosca 1/8" H - 1/8" H - 1/8" H acero inoxidable EC 13		
Para modelos:	FM1011E3, FM1011G3, FM1221E3, FM1221G3, FM611E3, FM611G3, FM721E3, FM721G3		

empalmes de tubo

plástico

1			
código	361735	referencia	33Q5040
descripción	empalme de tubo plástico acodado rosca 1/4" tubo ø 7mm UE 1 pzs		

latón niquelado



1

código	520159	referencia	3007950
descripción	empalme de tubo latón niquelado recto rosca 1/8" tubo ø 6mm UE 1 pzs EC 12 longitud total 32mm rosca L 7.5mm boquilla ø 6mm longitud boquilla 19.5mm		
Para modelos:	FM1011E3, FM1011G3, FM1221E3, FM1221G3, FM2021E3, FM2021G3, FM423E2, FM611E3, FM611G3, FM721E3, FM721G3		



1

código	517108	referencia	3110340
descripción	empalme de tubo latón niquelado acodado rosca 3/8" M - M10x1 H tubo ø 12mm UE 1 pzs		



1

código	519239	referencia	33Q4270
descripción	empalme de tubo latón niquelado rosca 1/4" tubo ø 11mm UE 1 pzs		



1

código	361507	referencia	3016150
descripción	racor tubular acodado latón niquelado rosca 1/4" tubo ø 6/8mm UE 1 pzs		



1

código	361506	referencia	3014470
descripción	racor tubular acodado latón niquelado rosca 1/8" tubo ø 6/8mm UE 1 pzs		
Para modelos:	FM1011E2-VERS.2006, FM1011E3, FM1011E3-VERS.2006, FM1011G2-VERS.2006, FM1011G3, FM1011G3-VERS.2006, FM1221E2-VERS.2006, FM1221E3, FM1221E3-VERS.2006, FM1221G2-VERS.2006, FM1221G3, FM1221G3-VERS.2006, FM2011E2-VERS.2006, FM2011E3-VERS.2006, FM2011G2-VERS.2006, FM2011G3-VERS.2006, FM2021E2-VERS.2006, FM2021E3-VERS.2006, FM2021G2-VERS.2006, FM2021G3-VERS.2006, FM423E2, FM611E2-VERS.2006, FM611E3, FM611E3-VERS.2006, FM611G2-VERS.2006, FM611G3, FM611G3-VERS.2006, FM721E2-VERS.2006, FM721E3, FM721E3-VERS.2006, FM721G2-VERS.2006, FM721G3, FM721G3-VERS.2006, FX101E2, FX101E2C, FX101E2C-VERS.032014, FX101E2R, FX101E2R-VERS.032014, FX101E2-VERS.032014, FX101E3, FX101E3C, FX101E3C-VERS.022014, FX101E3R, FX101E3R-VERS.022014, FX101E3-VERS.022014, FX101G2, FX101G2C, FX101G2C-VERS.032014, FX101G2R, FX101G2R-VERS.032014...(Otros modelos se puede ver en la tienda web)		

específico del fabricante



1

código	519291	referencia	3012220
descripción	empalme de tubo		



1

código	541490	referencia	33Q0590
descripción	empalme de tubo rosca 1/2" boquilla ø 15mm		
Para modelos:	ACBM, ACBM218, ANBM75, SL14CVB, SL21CVB, SL7NVB		



1

código	541489	referencia	33Q0150
descripción	empalme de tubo rosca 1/2" H boquilla ø 15mm		
Para modelos:	L40, L60		



1

código	520337	referencia	3007980
descripción	empalme de tubo rosca 1/4" boquilla ø 7mm int.ø 4.5mm longitud boquilla 19mm EC 14 longitud total 35mm rosca L 10mm		
Para modelos:	04WCP1EM, 06WCP1GM, 08WCP1GM, 091CP1E, 091CP1G, 0G1CP1EC, 0G1CP1E-VERS.2004, 0G1CP1G-VERS.2004, 191CP1G, 191CP2G, 1G1CP1G-VERS.2004, 1G1CP2G-VERS.2004, 6040090, 6040310, 6043850, 6043980, FM1011E3, FM1011G3, FM1221E3, FM1221G3, FM611E3, FM611G3, FM721E3, FM721G3		



1

código	541491	referencia	33Q1060
descripción	empalme de tubo rosca 3/4" boquilla ø 19mm		



			
1			
código	541497	referencia	33Q5450
descripción	empalme de tubo rosca 3/4" boquilla ø 28mm		
Para modelos:	FC101, FC101E, FC241, FC241E, FC241G, FC61, FC61E, FCV101, FCV101-CSA, FCV101DM, FCV101DM-CSA, FCV101DS, FCV101DS-CSA, FCV101E, FCV101EDM, FCV101EDM-UL, FCV101EDS, FCV101EDS-UL, FCV101E-UL, FCV141, FCV141-CSA, FCV141DM, FCV141DM-CSA, FCV141DS, FCV141DS-CSA, FCV141E, FCV141EDM, FCV141EDS, FCV241, FCV241DM, FCV241DS, FCV241E, FCV241EDM, FCV241EDM-UL, FCV241EDS, FCV241EDS-UL, FCV241E-UL, FCV241G, FCV241G-CSA, FCV241GDM, FCV241GDM-CSA, FCV241GDS, FCV241GDS-CSA, FCV3EM, FCV401DM, FCV401DM-CSA, FCV4E, FCV4EDS, FCV4EM, FCV61...(Otros modelos se puede ver en la tienda web)		

			
1			
código	541488	referencia	33Q5591 33Q5592
descripción	empalme de tubo rosca M14x1 M - 1/8" F acodado		
Para modelos:	FC101, FC101E, FC241, FC241E, FC241G, FC61, FC61E, FCV101, FCV101-CSA, FCV101DM, FCV101DM-CSA, FCV101DS, FCV101DS-CSA, FCV101E, FCV101EDM, FCV101EDM-UL, FCV101EDS, FCV101EDS-UL, FCV101E-UL, FCV141, FCV141-CSA, FCV141DM, FCV141DM-CSA, FCV141DS, FCV141DS-CSA, FCV141E, FCV141EDM, FCV141EDS, FCV241, FCV241DM, FCV241DS, FCV241E, FCV241EDM, FCV241EDM-UL, FCV241EDS, FCV241EDS-UL, FCV241E-UL, FCV241G, FCV241G-CSA, FCV241GDM, FCV241GDM-CSA, FCV241GDS, FCV241GDS-CSA, FCV3EM, FCV401DM, FCV401DM-CSA, FCV401EDM, FCV401EDM-UL, FCV4E, FCV4EDS...(Otros modelos se puede ver en la tienda web)		
accesorios para	541488		
	código	541507	referencia 33T4110
		boquilla refrigeración rosca 1/8"	
	código	541509	referencia 33T3720
		boquilla refrigeración rosca 1/8"	

válvulas y caños de pared

válvulas de bola

universal

válvulas de bola con maneta de mariposa

			
1			
código	542182	referencia	33A0850
descripción	válvula de bola empalme 1/2" H - 1/2" H DN15 longitud 50mm		

válvulas de bola con manilla de palanca

			
1			
código	540730	referencia	33D0170
descripción	válvula de bola empalme 3/4" H - 3/4" H DN20 longitud 70mm con manilla de palanca longitud de asidero 95mm		
Para modelos:	030BME, 030EBM, 030FE, 031BME, 031EBM, 070BM, 070BME, 071BM, 071BME, 090BM, 090BME, 091BM, 091BME, 30F, 30FES, 30FS, 70FES		

específico del fabricante

ANGELO PO

			
1			
código	514392	referencia	33D0250
descripción	válvula de bola entrada 1" F salida 1" F L 69mm sin asidero eje ø 9x12mm eje L 54mm		

			
1			
código	540687	referencia	33D0890
descripción	válvula de bola entrada 1" M salida 1" F L 92mm sin asidero eje ø 13x10mm		
Para modelos:	70F, 71F, 71FE		

			
1			
código	514080	referencia	33D1530
descripción	válvula de bola longitud de asidero 70mm L 83mm entrada 3/4" H manilla salida ø30mm		

válvulas de cierre

universal



código	540694	referencia	33D2040
descripción	válvula de cierre empalme 1/2" 1/2" sin asidero longitud 124.5mm pos. de montaje cualquiera eje L 15mm rosca de roseta G2 1" eje ø 7.8mm		
Para modelos:	0A1CP1E, 0A1CP1G, 0B1CP1G, 0D1CP1E, 0D1CP1G, 191CP1GA, 1A1BR1E, 1A1BR1G, 1A1BR1GA, 1A1BR2E, 1A1BR2EA, 1A1BR2G, 1A1BR2GA, 1A1CP1G, 1A1CP1GA, 1A1CP2G, 1A1PD1G, 1A1PD2G, 1A1PI1G, 1A1PI1GA, 1A1PI2E, 1A1PI2EA, 1A1PI2G, 1A1PI2GA, 1A1PI2VA, 1A1PI2VA, 1D1BR1E, 1D1BR1G, 1D1BR1GA, 1D1BR2E, 1D1BR2EA, 1D1BR2G, 1D1BR2GA, 1D1CP1G, 1D1CP1GA, 1D1CP2G, 1D1PD1G, 1D1PD2G, 1D1PI1G, 1D1PI1GA, 1D1PI2E, 1D1PI2EA, 1D1PI2G, 1D1PI2GA, 1D1PI2V, 1D1PI2VA, 2A1BR1E, 2A1BR1G, 2A1BR1GA, 2A1BR2E... (Otros modelos se puede ver en la tienda web)		
accesorios para	540694		
	código	514090	referencia —
	manilla en forma de estrella frío/caliente		
	código	520666	referencia 36Q0590
	tuerca de racor rosca 1/2" H 12mm		
	código	541818	referencia —
	roseta cromado rosca 28x19G ø 58mm H 25mm EC		

específico del fabricante

ANGELO PO

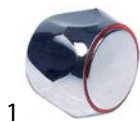

código	514357	referencia	36M2642 36M4010
descripción	manilla de grifo agua caliente para válvula plástico longitud 36mm alojamiento del eje ø8mmmm		
Para modelos:	070BM, 070BME, 071BM, 071BME, 090BM, 090BME, 091BM, 091BME, 0A1CP1E, 0A1CP1G, 0B1CP1G, 0D1CP1E, 0D1CP1G, 1A1BR1E, 1A1BR1G, 1A1BR1GA, 1A1BR2E, 1A1BR2EA, 1A1BR2G, 1A1BR2GA, 1A1CP1G, 1A1CP2G, 1A1PD1G, 1A1PD2G, 1A1PI1G, 1A1PI1GA, 1A1PI2E, 1A1PI2EA, 1A1PI2G, 1A1PI2GA, 1A1PI2V, 1A1PI2VA, 1D1BR1E, 1D1BR1G, 1D1BR1GA, 1D1BR2E, 1D1BR2EA, 1D1BR2G, 1D1BR2GA, 1D1CP1G, 1D1CP2G, 1D1PD1G, 1D1PD2G, 1D1PI1G, 1D1PI1GA, 1D1PI2E, 1D1PI2EA, 1D1PI2G, 1D1PI2GA, 1D1PI2V... (Otros modelos se puede ver en la tienda web)		

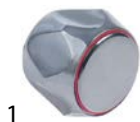

código	514383	referencia	36M2641
descripción	manilla en forma de estrella caliente longitud 36mm soporte de eje ø 8mm plástico para válvula		
Para modelos:	070BM, 070BME, 071BM, 071BME, 090BM, 090BME, 091BM, 091BME, 0A0BME, 0A0BMG, 0A1CP1E, 0A1CP1G, 0B1CP1G, 0D0BME, 0D0BMG, 0D1CP1E, 0D1CP1G, 0G1CP1E, 0G1CP1G, 191PD1G, 191PD2G, 191PI1G, 191PI1GA, 191PI2E, 191PI2EA, 191PI2G, 191PI2GA, 191PI2V, 191PI2VA, 1A0BME, 1A0BMG, 1A1BR1E, 1A1BR1G, 1A1BR1GA, 1A1BR2E, 1A1BR2EA, 1A1BR2G, 1A1BR2GA, 1A1CP1G, 1A1CP2G, 1A1PD1G, 1A1PD2G, 1A1PI1G, 1A1PI1GA, 1A1PI2E, 1A1PI2EA, 1A1PI2V, 1A1PI2VA, 1D0BME, 1D0BMG... (Otros modelos se puede ver en la tienda web)		

VÁLVULAS Y CAÑOS DE PARED ANGELO-PO

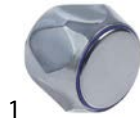

código	541813	referencia	36M2631 36M2632
descripción	manilla en forma de estrella frío longitud 36mm soporte de eje ø 8mm plástico para válvula		
Para modelos:	191PD1G, 191PD2G, 191PI1G, 191PI1GA, 191PI2E, 191PI2EA, 191PI2G, 191PI2GA, 191PI2V, 191PI2VA, 1A1PD1G, 1A1PD2G, 1A1PI1G, 1A1PI1GA, 1A1PI2E, 1A1PI2EA, 1A1PI2G, 1A1PI2GA, 1A1PI2VA, 1D1PD1G, 1D1PD2G, 1D1PI1G, 1D1PI1GA, 1D1PI2E, 1D1PI2EA, 1D1PI2G, 1D1PI2GA, 1G1PD1G, 1G1PI1E, 1G1PI1G, 291PI3E, 291PI3G, 31PD6, 31PI6, 31PIE6, 71AR, 71ARE, 71PD10, 71PD15, 71PI10, 71PI10A, 71PIE15, 71PIE15A, 71PV15, 71PV15A, 71RA, 91AR, 91ARE, 91PI10, 91PI10A, 91PIE15... (Otros modelos se puede ver en la tienda web)		



código	514385	referencia	3005990 33D2930
descripción	válvula de cierre empalme 3/8" 3/8" sin asidero pos. de montaje cualquiera		
Para modelos:	0A0BME, 0A0BMG, 0A1CP1E, 0A1CP1G, 0B1CP1G, 0D0BME, 0D0BMG, 0D1CP1E, 0D1CP1G, 0G1CP1E, 0G1CP1G, 191PD1G, 191PD2G, 191PI1G, 191PI1GA, 191PI2E, 191PI2EA, 191PI2G, 191PI2GA, 191PI2V, 191PI2VA, 1A0BME, 1A0BMG, 1A1BR1E, 1A1BR1G, 1A1BR1GA, 1A1BR2E, 1A1BR2EA, 1A1BR2G, 1A1BR2GA, 1A1CP1G, 1A1CP2G, 1A1PD1G, 1A1PD2G, 1A1PI1G, 1A1PI1GA, 1A1PI2E, 1A1PI2EA, 1A1PI2G, 1A1PI2GA, 1A1PI2VA, 1A1PI2VA, 1D0BME, 1D0BMG, 1D1BR1E, 1D1BR1G, 1D1BR1GA, 1D1BR2E, 1D1BR2EA, 1D1BR2G... (Otros modelos se puede ver en la tienda web)		

repuestos para	514385		
	código	541533	referencia —
	manilla agua fría H 39.5mm azul int. ø 32.5mm ø ext. 50mm		
	código	541813	referencia 36M2631 36M2632
	manilla en forma de estrella frío longitud 36mm soporte de eje ø 8mm plástico para válvula		



código	541587	referencia	6300728
descripción	válvula de cierre empalme 3/8" kit de modificación		
Para modelos:	1A1BR1E, 1A1BR1G, 1A1BR1GA, 1A1BR2E, 1A1BR2EA, 1A1BR2G, 1A1BR2GA, 1D1BR1E, 1D1BR1G, 1D1BR1GA, 1D1BR2E, 1D1BR2EA, 1D1BR2G, 1D1BR2GA, 2A1BR1E, 2A1BR1G, 2A1BR1GA, 2A1BR2E, 2A1BR2EA, 2A1BR2G, 2A1BR2GA, 2D1BR1E, 2D1BR1G, 2D1BR1GA, 2D1BR2E, 2D1BR2EA, 2D1BR2G, 2D1BR2GA		



1

código	541588	referencia	6300729
descripción	válvula de cierre empalme 3/8" kit de modificación		
Para modelos:	0A1CP1E, 0A1CP1G, 0D1CP1E, 0D1CP1G, 191CP1GA, 1A1CP1G, 1A1CP2G, 1D1CP1G, 1D1CP2G		

1

código	541589	referencia	6300727
descripción	válvula de cierre empalme 3/8" kit de modificación		
Para modelos:	0A0BME, 0A0BMG, 0D0BME, 0D0BMG, 1A0BME, 1A0BMG, 1D0BME, 1D0BMG		

1

código	541584	referencia	6300730
descripción	válvula de cierre empalme 3/8" kit de modificación UE 2 pzs		
Para modelos:	1A1PD1G, 1A1PD2G, 1A1PI1G, 1A1PI1GA, 1D1PD1G, 1D1PD2G, 1D1PI1G, 1D1PI1GA		

1

código	540690	referencia	33D0590
descripción	válvula de cierre empalme 3/8" longitud 27mm pos. de montaje acodado soporte de eje ø M4mm rosca de roseta G2 1" eje en forma de estrella		
Para modelos:	070BM, 070BME, 071BM, 071BME, 090BM, 090BME, 091BM, 091BME, 30CPS, 30CPSE, 31PD6, 31PI6, 31PIE6, 70CP, 70CPE, 71AR, 71ARE, 71CP, 71CP2, 71PD10, 71PD15, 71PI10, 71PI10A, 71PIE15, 71PIE15A, 71PV15, 71PV15A, 71RA, 90CP, 90CPE, 91AR, 91ARE, 91CP, 91PI10, 91PI10A, 91PIE15, 91PIE15A, 91RA, ACBM, ACBM218, ANBM, ANBM218, ANBM75, SE14VB, SE21VB, SI14VB, SI21VB, SL14CVB, SL14NVB, SL21CVB...(Otros modelos se puede ver en la tienda web)		
repuestos para	540690		
	código	541357	referencia 36M2642 36M4010
	manilla de grifo agua caliente para válvula plástico longitud 36mm alojamiento del eje ø8mmmm		
	código	541813	referencia 36M2631 36M2632
	manilla en forma de estrella frío longitud 36mm soporte de eje ø 8mm plástico para válvula		

1

código	541590	referencia	6300731
descripción	válvula de cierre empalme 3/8" M kit de modificación longitud 97mm		

accesorios

1

código	540696	referencia	36M4030
descripción	manilla de campana para válvula azul		
Para modelos:	04WBMEV, 191CP1GA, 1A1CP1GA, 1A1PD1G, 1A1PD2G, 1A1PI1G, 1A1PI1GA, 1A1PI2E, 1A1PI2EA, 1A1PI2G, 1A1PI2GA, 1A1PI2V, 1A1PI-2VA, 1D1CP1GA, 1D1PD1G, 1D1PD2G, 1D1PI1G, 1D1PI1GA, 1D1PI2E, 1D1PI2EA, 1D1PI2G, 1D1PI2GA, 1D1PI2V, 1D1PI2VA, 291PD3G, 2A1PD3G, 2A1PI3E, 2A1PI3G, 2D1PI3G		

1

código	514438	referencia	3162200
descripción	manilla en forma de estrella plástico rosca 7.5 ø 50mm H 50mm EC cromado eje en forma de estrella		
Para modelos:	0A0BME, 0A0BMG, 0A1CP1E, 0A1CP1G, 0D0BME, 0D0BMG, 0D1CP1E, 0D1CP1G, 0G1CP1E, 0G1CP1G, 191PD1G, 191PD2G, 191PI1G, 191PI1GA, 191PI2E, 191PI2EA, 191PI2G, 191PI2GA, 191PI2V, 191PI-2VA, 1A0BME, 1A0BMG, 1A1BR1E, 1A1BR1G, 1A1BR1GA, 1A1BR2E, 1A1BR2EA, 1A1BR2G, 1A1BR2GA, 1A1CP1G, 1A1CP2G, 1A1PD1G, 1A1PD2G, 1A1PI1G, 1A1PI1GA, 1A1PI2E, 1A1PI2EA, 1A1PI2V, 1A1PI-2VA, 1D0BME, 1D0BMG, 1D1BR1E, 1D1BR1G, 1D1BR1GA, 1D1BR2E, 1D1BR2EA, 1D1BR2G, 1D1BR2GA, 1D1CP1G, 1D1CP2G...(Otros modelos se puede ver en la tienda web)		

válvulas de vapor



código	520000	referencia	33G0030 33G0031
descripción	válvula de vapor acodado empalme 1 1/4" F longitud 52mm H 190mm latón		
Para modelos:	191PI2V, 191PI2VA, 1A1PI2V, 1A1PI2VA, 1D1PI2V, 1D1PI2VA, 71PV15, 71PV15A, PV200, PV200A, PV300, PV300A		
repuestos para	520000		
	código	541566	referencia —
	montura para grifo de vapor 1 1/4" eje 9x9mm		
	código	541567	referencia —
	manilla en forma de estrella eje 9x9mm ø 74mm L 24mm negro plástico		

válvulas de entrada



código	541816	referencia	33Q4690
descripción	tubo de entrada empalme 3/8" H para baño maría		
Para modelos:	0A0BME, 0A0BMG, 0D0BME, 0D0BMG, 1A0BME, 1A0BMG, 1D0BME, 1D0BMG		



código	514078	referencia	33Q2730
descripción	tubo de entrada empalme 3/8" M tubo ø 10mm saliente 48mm altura total 46mm altura salida 25mm		
Para modelos:	070BM, 070BME, 071BM, 071BME, 090BM, 090BME, 091BM, 091BME, 30CPS, 30CPSE, 70CP, 70CPE, 71CP, 71CP2, 90CP, 90CPE, 91CP		
accesorios para	514078		
	código	101278	referencia 36Q0080
	anillo cortante para tubo ø 10mm UE 1 pzs		
	código	101478	referencia —
	tuerca de racor rosca 3/8" para ø de tubo 10mm		

accesorios para	514078		
	código	506024	referencia —
	tuerca rosca 3/8" H 6mm inox EC 22 UE 1 pzs		
	código	514079	referencia 3120740
	arandela ø ext. 30mm int.ø 17mm espesor 3mm		
	código	540682	referencia 3150840 37Q1210
	junta tórica EPDM espesor 1.78mm int.ø 18.77mm UE 1 pzs		

1			
código	514081	referencia	3003440 3003441 33Q3500
descripción	tubo de entrada empalme 3/8" M tubo ø 10mm saliente 50mm altura total 56mm altura salida 25mm ángulo de rotación°		
Para modelos:	04WCP1EM, 06WCP1GM, 08WCP1GM, 091CP1E, 091CP1G, 0A1CP1E, 0A1CP1G, 0B1CP1G, 0D1CP1E, 0D1CP1G, 0G1CP1E, 0G1CP1EC, 0G1CP1E-VERS.2004, 0G1CP1G, 0G1CP1G-VERS.2004, 191CP1G, 191CP2G, 1A1CP1G, 1A1CP2G, 1D1CP1G, 1D1CP2G, 1G1CP1G, 1G1CP1G-VERS.2004, 1G1CP2G, 1G1CP2G-VERS.2004, 6040090, 6040310, 6043850, 6043980		

accesorios para	514081		
	código	503042	referencia 33Q2190 36Q1110
	tuerca rosca 3/8" H 6mm latón EC 22 UE 1 pzs		
	código	540682	referencia 3150840 37Q1210
	junta tórica EPDM espesor 1.78mm int.ø 18.77mm UE 1 pzs		

1			
código	540693	referencia	33Q2582
descripción	tubo de entrada para marmita serie 700/900		
Para modelos:	31PD6, 31PI6, 31PIE6, 71PD10, 71PD15, 71PI10, 71PI10A, 71PIE15, 71PIE15A, 71PV15, 71PV15A, 91PI10, 91PI10A, 91PIE15, 91PIE15A		



			
código	540697	referencia	3003430 33Q3570
descripción	tubo de entrada tubo ø 18mm rosca 1/2" H para marmita		
Para modelos:	191PD1G, 191PD2G, 191PI1G, 191PI1GA, 191PI2E, 191PI2EA, 191PI2G, 191PI2GA, 191PI2V, 191PI2VA, 1A1PD1G, 1A1PD2G, 1A1PI1G, 1A1PI1GA, 1A1PI2E, 1A1PI2EA, 1A1PI2G, 1A1PI2GA, 1A1PI2V, 1A1PI2VA, 1D1PD1G, 1D1PD2G, 1D1PI1G, 1D1PI1GA, 1D1PI2E, 1D1PI2EA, 1D1PI2G, 1D1PI2GA, 1D1PI2V, 1D1PI2VA, 1G1PD1G, 1G1PI1E, 1G1PI1G		

			
código	540691	referencia	36M2640
descripción	manilla de camapana para válvula rojo		
Para modelos:	070BM, 070BME, 071BM, 071BME, 090BM, 090BME, 091BM, 091BME, 0A0BME, 0A0BMG, 0A1CP1E, 0A1CP1G, 0B1CP1G, 0D0BME, 0D0BMG, 0D1CP1E, 0D1CP1G, 0G1CP1E, 0G1CP1G, 1A0BME, 1A0BMG, 1A1BR1E, 1A1BR1G, 1A1BR1GA, 1A1BR2E, 1A1BR2EA, 1A1BR2G, 1A1BR2GA, 1A1CP1G, 1A1CP2G, 1A1PD1G, 1A1PD2G, 1A1PI1G, 1A1PI1GA, 1A1PI2E, 1A1PI2EA, 1A1PI2V, 1A1PI2VA, 1D0BME, 1D0BMG, 1D1BR1E, 1D1BR1G, 1D1BR1GA, 1D1BR2E, 1D1BR2EA, 1D1BR2G, 1D1BR2GA, 1D1CP1G, 1D1CP2G, 1D1PD1G...(Otros modelos se puede ver en la tienda web)		

accesorios

asideros giratorios

			
código	540692	referencia	36M2630
descripción	manilla de camapana para válvula azul		
Para modelos:	1A1PD1G, 1A1PD2G, 1A1PI1G, 1A1PI1GA, 1A1PI2E, 1A1PI2EA, 1A1PI2V, 1A1PI2VA, 1D1PD1G, 1D1PD2G, 1D1PI1G, 1D1PI1GA, 1D1PI2E, 1D1PI2EA, 1D1PI2V, 1D1PI2VA, 1G1PD1G, 1G1PI1E, 1G1PI1G, 31PD6, 31PI6, 31PIE6, 71AR, 71ARE, 71PD10, 71PD15, 71PI10, 71PI10A, 71PIE15, 71PIE15A, 71PV15, 71PV15A, 71RA, 91AR, 91ARE, 91PI10, 91PI10A, 91PIE15, 91PIE15A, 91RA		

			
código	540696	referencia	36M4030
descripción	manilla de camapana para válvula azul		
Para modelos:	04WBMEV, 191CP1GA, 1A1CP1GA, 1A1PD1G, 1A1PD2G, 1A1PI1G, 1A1PI1GA, 1A1PI2E, 1A1PI2EA, 1A1PI2G, 1A1PI2GA, 1A1PI2V, 1A1PI2VA, 1D1CP1GA, 1D1PD1G, 1D1PD2G, 1D1PI1G, 1D1PI1GA, 1D1PI2E, 1D1PI2EA, 1D1PI2G, 1D1PI2GA, 1D1PI2V, 1D1PI2VA, 291PD3G, 2A1PD3G, 2A1PI3E, 2A1PI3G, 2D1PI3G		

tecnología de bebida

válvulas

válvulas de retención

			
código	440729	referencia	3114800
descripción	válvula de retención John Guest empalme de tubo 5/16" - 5/16" presión de trabajo a 20°C 10bar presión de apertura 0.02bar POM		
Para modelos:	FM1011E3-VERS.2006, FM1011G3-VERS.2006, FM1221E3-VERS.2006, FM1221G3-VERS.2006, FM2011E3-VERS.2006, FM2011G3-VERS.2006, FM2021E3-VERS.2006, FM2021G3-VERS.2006, FM611E3-VERS.2006, FM611G3-VERS.2006, FM721E3-VERS.2006, FM721G3-VERS.2006, FX101E3, FX101E3C, FX101E3C-VERS.022014, FX101E3R, FX101E3R-VERS.022014, FX101E3-VERS.022014, FX101G3, FX101G3C, FX101G3C-VERS.022014, FX101G3R, FX101G3R-VERS.022014, FX101G3-VERS.022014, FX10E3CR, FX10E3CR-VERS.022014, FX10G3CR, FX10G3CR-VERS.022014, FX122E3, FX122E3C, FX122E3T, FX122E3T-VERS.022014, FX122G3, FX122G3C, FX122G3T, FX122G3T-VERS.022014, FX12E3CT, FX12E3CT-VERS.022014, FX12G3CT, FX12G3CT-VERS.022014, FX201E3, FX201E3P, FX201E3P-VERS.022014, FX201E3-VERS.022014, FX201G3P, FX201G3-VERS.022014, FX202E3, FX202E3-230V-3-50Hz-60Hz, FX202E3-230V-3-50Hz-60Hz-VERS.022014, FX202E3-VERS.022014...(Otros modelos se puede ver en la tienda web)		

componentes para el circuito agua

reductores de presión

reductores de presión

universal



1

código	520271	referencia	33D1650
descripción	reductor de presión empalme 1/2" preajuste 3bar margen de ajuste 1 a 7bar p máx. 20bar T máx 80°C		
Para modelos:	BX101E, BX101E-VERS.122013, BX101G, BX101G-VERS.122013, BX122E, BX122E-VERS.122013, BX122G, BX122G-VERS.122013, BX61E, BX61E-VERS.122013, BX61G, BX61G-VERS.122013, BX82E, BX82E-VERS.122013, BX82G, BX82G-VERS.122013, FCV101, FCV101-CSA, FCV101DM, FCV101DM-CSA, FCV101DS, FCV101DS-CSA, FCV101E, FCV101EDM, FCV101EDM-UL, FCV101EDS, FCV101EDS-UL, FCV101E-UL, FCV141, FCV141-CSA, FCV141DM, FCV141DM-CSA, FCV141DS, FCV141DS-CSA, FCV141E, FCV141EDM, FCV141EDS, FCV241, FCV241DM, FCV241DS, FCV241E, FCV241EDM, FCV241EDM-UL, FCV241EDS, FCV241EDS-UL, FCV241E-UL, FCV241G, FCV241G-CSA, FCV241GDM, FCV241GDM-CSA...(Otros modelos se puede ver en la tienda web)		

filtros de entrada



1

código	520261	referencia	35Q2780
descripción	filtro de entrada rosca 1/2" H - 1/2" H longitud 58mm latón rojo luz de malla 0.4mm		

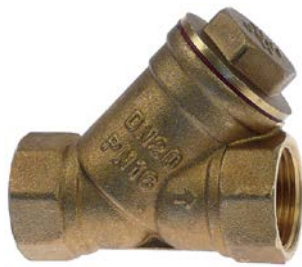

1

código	520262	referencia	33Q6090 33Q6091 35Q2790
descripción	filtro de entrada rosca 3/4" H - 3/4" H longitud 70mm latón rojo DN20 luz de malla 0.4mm		

material auxiliar

abrazaderas

abrazaderas de tubo

DIN 3017 - W2



1

código	520111	referencia	36E4320
descripción	abrazadera de tubo ø 10-16mm ancho 9mm UE 10 pzs DIN 3017		
Para modelos:	FM1011E2-VERS.2006, FM1011E3, FM1011E3-VERS.2006, FM1011G2-VERS.2006, FM1011G3, FM1011G3-VERS.2006, FM1221E2-VERS.2006, FM1221E3, FM1221E3-VERS.2006, FM1221G2-VERS.2006, FM1221G3, FM1221G3-VERS.2006, FM2011E2-VERS.2006, FM2011E3-VERS.2006, FM2011G2-VERS.2006, FM2011G3-VERS.2006, FM2021E2-VERS.2006, FM2021E3, FM2021E3-VERS.2006, FM2021G2-VERS.2006, FM2021G3, FM2021G3-VERS.2006, FM423E2, FM611E2-VERS.2006, FM611E3, FM611E3-VERS.2006, FM611G2-VERS.2006, FM611G3, FM611G3-VERS.2006, FM721E2-VERS.2006, FM721E3, FM721E3-VERS.2006, FM721G2-VERS.2006, FM721G3, FM721G3-VERS.2006		



1

código	520115	referencia	3140220
descripción	abrazadera de tubo ø 25-40mm ancho 9mm UE 10 pzs DIN 3017		



1

código	520119	referencia	3140200
descripción	abrazadera de tubo ø 60-80mm ancho 9mm UE 5 pzs DIN 3017		
Para modelos:	L100, L80, LP202, LP202HC, LP302, LP302HC, LP402, LP402HC, LP402V		



herramientas

herramientas de mano

extractora



1

código	801197	referencia	3018670 6003060
descripción	extractora para rodete de ventilador soporte ø 27-33mm rosca M16x1,5 EC 17		
Para modelos:	FM1011E1, FM1011E2, FM1011E3, FM1011G1, FM1011G2, FM1011G3, FM1221E1, FM1221E2, FM1221E3, FM1221G1, FM1221G2, FM1221G3, FM611E1, FM611E2, FM611E3, FM611G1, FM611G2, FM611G3		
repuestos para	801197		
	código	referencia	3019160
	tornillo para extractora rosca M16x1,5 L 63mm EC 17		



1

código	801198	referencia	3019160
descripción	tornillo para extractora rosca M16x1,5 L 63mm EC 17		

sistemas de medición

termómetros

termómetros incorporados



1

código	541086	referencia	32V1900 32z0020
descripción	termómetro medida de montaje 58x25,5mm 0 a +120°C capilar 2000mm sonda ø 6mm sonda L 23mm		
Para modelos:	LC100, LC100-VERS.2001, LC130, LC130-VERS.2001		



1

código	541305	referencia	32V7230
descripción	termómetro medida de montaje 62x11mm +20 a +120°C capilar 1500mm sonda ø 6.5mm sonda L 16mm		

ø52mm



1

código	541065	referencia	32z2930
descripción	termómetro montaje ø 52mm T máx 120°C 0 a +120°C sonda ø 6.5mm sonda L 28mm capilar 1500mm		



1

código	541347	referencia	32Z0151
descripción	termómetro montaje ø 52mm T máx 350°C +50 a +350°C sonda ø 4mm sonda L 60mm capilar 1000mm		
Para modelos:	FC101, FC1011E, FC1011G, FC101E, FC1221E, FC1221G, FC241, FC241E, FC241G, FC61, FC611E, FC611G, FC61E		



1

código	541582	referencia	32Z0040
descripción	termómetro montaje ø 52mm T máx 350°C +50 a +350°C sonda ø 6mm sonda L 17mm capilar 1700mm		

ø60mm



1

código	541082	referencia	32Z3190
descripción	termómetro montaje ø 60mm T máx 40°C -40 a +40°C sonda ø 6mm sonda L 135mm capilar 2000mm		

alimentación eléctrica externa



código	541193	referencia	32Z3670 32Z3680
descripción	termómetro medida de montaje 58x25,5mm -40 a +40°C longitud del cable 2500mm sonda ø 6mm sonda L 40mm		
Para modelos:	SA87		

tornillos prisioneros

DIN 914/ISO 4027



código	560224	referencia	31W0020
descripción	tornillo prisionero rosca M8 L 10mm EC 4 UE 1 pzs		
Para modelos:	1A1BR1E, 1A1BR1G, 1A1BR2E, 1A1BR2G, 1D1BR1E, 1D1BR1G, 1D1BR2E, 1D1BR2G, 1G1BR1E, 1G1BR1G, 2A1BR1E, 2A1BR1G, 2A1BR2E, 2A1BR2G, 2D1BR1E, 2D1BR1G, 2D1BR2E, 2D1BR2G, 31R, 31RE		

material de sujeción

tornillos

tornillos de cabeza avellanada



código	698481	referencia	31C0070
descripción	tornillo rosca M4 L 8mm inox DIN 965/ISO 7046 UE 1 pzs soporte Phillips ø cabezal 7mm		
Para modelos:	LC100, LC100-VERS.2001, LC130, LC130-VERS.2001, LC80, LF50, LF50E, LF50EM, LF50EMPS		

tornillos de cabeza moleteada



código	524804	referencia	3036730
descripción	tornillo de cabeza moleteada rosca M5 rosca L 7mm ø 30mm H 5mm inox UE 1 pzs		
Para modelos:	KD100, KD100A, KD100PSD, KD130, KD130A, KD130E, KD130EAT, KD40EPSD, KD40LEPS, KD40LUXE, KD60, KD60E, KD60EAT, KD60M, KD60MA, KD60ME, KD60MPS, KD60MPSA, KD60PS, KD60PSD, KD6E-ATSD, KD85, KD85A, KD85E, KD85EA, KD85EAT, KD85EATS, KD85EPS, KD85EPSA, KD85PS, KD85PSA, KN1100, KN1100SD, KN11PSDD, KN80, KN80PS, LP151, LP202, LP202HC, LP302, LP302HC, LP402, LP402HC, LP402V, LP70		

tuercas hexagonales



código	506445	referencia	3016470
descripción	tornillo de cabeza hexagonal rosca M10 rosca L 35mm inox EC 17 UE 1 pzs DIN 933 / ISO 4017		
Para modelos:	BX101E, BX101E-VERS.122013, BX101G, BX101G-VERS.122013, BX122E, BX122E-VERS.122013, BX122G, BX122G-VERS.122013, BX61E, BX61E-VERS.122013, BX61G, BX61G-VERS.122013, BX82E, BX82E-VERS.122013, BX82G, BX82G-VERS.122013, FC1011E, FC1011G, FC1221E, FC1221G, FC611E, FC611G, FM1011E1, FM1011E1-VERS.2006, FM1011E2, FM1011E2-VERS.2006, FM1011E3, FM1011E3-VERS.2006, FM1011G1, FM1011G1-VERS.2006, FM1011G2, FM1011G2-VERS.2006, FM1011G3, FM1011G3-VERS.2006, FM1221E1, FM1221E1-VERS.2006, FM1221E2, FM1221E2-VERS.2006, FM1221E3, FM1221E3-VERS.2006, FM1221G1, FM1221G1-VERS.2006, FM1221G2, FM1221G2-VERS.2006, FM1221G3, FM1221G3-VERS.2006, FM2011E2-VERS.2006, FM2011E3-VERS.2006, FM2011G2-VERS.2006, FM2011G3-VERS.2006...(Otros modelos se puede ver en la tienda web)		

accesorios para 524804



código	505277	referencia	3036720 33q6400
descripción	perno de aclarado sistemas de lavado ø 14mm H 38mm rosca 1/4"		



código	560086	referencia	31A0560
descripción	tornillo de cabeza hexagonal rosca M6 rosca L 10mm inox EC 10 UE 20 pzs DIN 933 / ISO 4017		
Para modelos:	BX101E, BX101E-VERS.122013, BX101G, BX101G-VERS.122013, BX122E, BX122E-VERS.122013, BX122G, BX122G-VERS.122013, BX61E, BX61E-VERS.122013, BX61G, BX61G-VERS.122013, BX82E, BX82E-VERS.122013, BX82G, BX82G-VERS.122013, FX101E1, FX101E1R, FX101E2, FX101E2C, FX101E2C-VERS.032014, FX101E2R, FX101E2R-VERS.032014, FX101E2-VERS.032014, FX101E3, FX101E3C, FX101E3C-VERS.022014, FX101E3R, FX101E3R-VERS.022014, FX101E3-VERS.022014, FX101G1, FX101G1R, FX101G2, FX101G2C, FX101G2C-VERS.032014, FX101G2R, FX101G2R-VERS.032014, FX101G2-VERS.032014, FX101G3, FX101G3C, FX101G3C-VERS.022014, FX101G3R, FX101G3R-VERS.022014, FX101G3-VERS.022014, FX10E2CR, FX10E2CR-VERS.032014, FX10E3CR, FX10E3CR-VERS.022014, FX10G2CR, FX10G2CR-VERS.032014...(Otros modelos se puede ver en la tienda web)		

otros



código	514285	referencia	3190040
descripción	tornillo		
Para modelos:	090GRG, 190GRG, FC101, FC1011E, FC1011G, FC101E, FC1221E, FC1221G, FC241, FC241E, FC241G, FC61, FC611E, FC611G, FC61E, FCV101, FCV101-CSA, FCV101DM, FCV101DM-CSA, FCV101DS, FCV101DS-CSA, FCV101E, FCV101EDM, FCV101EDM-UL, FCV101EDS, FCV101EDS-UL, FCV101E-UL, FCV141, FCV141-CSA, FCV141DM, FCV141DM-CSA, FCV141DS, FCV141DS-CSA, FCV141E, FCV141EDM, FCV141EDS, FCV241, FCV241DM, FCV241DS, FCV241E, FCV241EDM, FCV241EDM-UL, FCV241EDS, FCV241EDS-UL, FCV241E-UL, FCV241G, FCV241G-CSA, FCV241GDM, FCV241GDM-CSA, FCV241GDS...(Otros modelos se puede ver en la tienda web)		



			
1			
código	691459	referencia	3190020
descripción	tornillo rosca M6 L 10mm EC 14		
Para modelos:	FC101, FC1011E, FC1011G, FC101E, FC1221E, FC1221G, FC241, FC241E, FC241G, FC61, FC611E, FC611G, FC61E, FCV101, FCV101-CSA, FCV101DM, FCV101DM-CSA, FCV101DS, FCV101DS-CSA, FCV101E, FCV101EDM, FCV101EDM-UL, FCV101EDS, FCV101EDS-UL, FCV101E-UL, FCV141, FCV141-CSA, FCV141DM, FCV141DM-CSA, FCV141DS, FCV141DS-CSA, FCV141E, FCV141EDM, FCV141EDS, FCV241, FCV241DM, FCV241DS, FCV241E, FCV241EDM, FCV241EDM-UL, FCV241EDS, FCV241EDS-UL, FCV241E-UL, FCV241G, FCV241G-CSA, FCV241GDM, FCV241GDM-CSA, FCV241GDS, FCV241GDS-CSA, FCV3EM...(Otros modelos se puede ver en la tienda web)		

tuercas

tuercas de mariposa

			
1			
código	560147	referencia	33Q3200
descripción	tuerca de mariposa rosca M6 inox DIN/ISO DIN 315 UE 20 pzs		
Para modelos:	LT10R, LT20F, LT25F		

tuercas moleteadas

			
1			
código	519386	referencia	3190800
descripción	tuerca moleteada para vidrio rosca M4		
Para modelos:	BRPRV, BRVRV, SE14PRV, SE14PRW, SE14VRV, SE14VRW, SI14PRV, SI14PRW, SI14VRV, SI14VRW, SL14RPRV, SL14RPRW, SL14RVRV, SL14RVRW, TPRV, TVRV		

tuercas hexagonales

DIN 934 / ISO 4032/8673

			
1			
código	517174	referencia	3110050 33Q6470
descripción	tuerca rosca M8 H 6.5mm EC 13 inox DIN/ISO DIN 934 / ISO 4032/8673 UE 1 pzs		

tuercas hexagonales métricas (sin norma)

			
1			
código	521103	referencia	N/A
descripción	tuerca rosca M4 H 3mm EC 7 latón UE 20 pzs		

tuercas hexagonales pulgadas

			
1			
código	517180	referencia	3030170
descripción	tuerca rosca 1" H 5mm EC 36 inox UE 1 pzs		
Para modelos:	KD37, KD37PS, KD37-VERS.112009, KD40, LP202, LP202HC, LP302, LP302HC, LP402, LP402HC, LP402V, LPG300, N100D, N100S, N100VD, N100VS, N38D, N38S, N38VD, N38VS, N42D, N42S, N42VD, N42VS, N50D, N50S, N50VD, N50VS, N66D, N66S, N66VD, N66VS, N70D, N70S, N70VD, N70VS, N85D, N85S, N85VD, N85VS		

			
1			
código	503155	referencia	33Q4410
descripción	tuerca rosca 1/2" H 7mm EC 25 latón UE 1 pzs		
Para modelos:	LT10R, LT20F, LT25F		

			
1			
código	361182	referencia	3117580
descripción	tuerca rosca 1/4" H 5mm latón niquelado EC 17 UE 1 pzs		
Para modelos:	L100, L40, L40S, L60, L80, P5		

			
1			
código	503042	referencia	33Q2190 36Q1110
descripción	tuerca rosca 3/8" H 6mm latón EC 22 UE 1 pzs		
Para modelos:	030FT, 030FTR, 031FT, 031FT04, 031FT06, 031FTR, 031FTRL, 04WB-MEV, 06WFR3GD, 070BM, 070BME, 070FT, 070FT04, 070FT05, 070FTR, 0712VA, 071BM, 071BME, 071FT, 071FT04, 071FT06, 071FTR, 071FTRL, 08WGREV, 090BM, 090BM1E, 090BM1G, 090BME, 090FAVA, 090FT, 090FT04, 090FT05, 090FT1G, 090FT2G, 090FT4G, 090FT5G, 090FT7G, 090FTR, 091BM, 091BME, 091CP1E, 091CP1G, 091FR1EA, 091FR1EX, 091FR1I, 091FR1IA, 091FR1ID, 091FR1ID-VERS.052012, 091FR1I-VERS.032012, 091FR7G...(Otros modelos se puede ver en la tienda web)		

			
1			
código	511182	referencia	33Q2190
descripción	tuerca rosca 3/8" H 8mm latón EC 24 UE 1 pzs		
Para modelos:	C165D, C165S, C165VD, C165VS, C207D, C207D-VERS.2006, C207S, C207S-VERS.2006, C207VD, C207VD-VERS.2006, C207VS, C207VS-VERS.2006, C304AD, C304AD-VERS.2006, C304AS, C304AS-VERS.2006, C304AVD, C304AVD-VERS.2006, C304AVS, C304AVS-VERS.2006, C304D, C304D-VERS.2006, C304S, C304S-VERS.2006, C304VD, C304VD-VERS.2006, C304VS, C304VS-VERS.2006, C92D-VERS.2006, C92S-VERS.2006, C92VD-VERS.2006, C92VS-VERS.2006, CS243D, CS243D-VERS.2006, CS243S, CS243S-VERS.2006, CS243VD, CS243VD-VERS.2006, CS243VS, CS243VS-VERS.2006, CS370AD, CS370AD-VERS.2006, CS370AS, CS370AS-VERS.2006, CS370AVD, CS370AVD-VERS.2006, CS370AVS, CS370AVS-VERS.2006, CS370D, CS370D-VERS.2006...(Otros modelos se puede ver en la tienda web)		

			
1			
código	511309	referencia	33Q0240
descripción	tuerca rosca 1 1/2" ø 66mm H 9mm EC 51 latón UE 1 pzs		
Para modelos:	L100, L40, L40S, L60, L80		

tuercas de racor

			
1			
código	520667	referencia	36Q0100
descripción	tuerca de racor rosca 1/4" H 11mm acero EC 17 UE 1 pzs		

arandelas

arandelas elásticas

			
1			
código	560209	referencia	3000860
descripción	arandela grower int.ø 10.3mm ø ext. 17.2mm inox UE 1 pzs para rosca M10		
Para modelos:	08WGRGV, 090GRG, 0A0GRG, 0D0GRG, 190GRG, 1A0GRG, 1D0GRG		

<p>arandelas</p>			
<p>DIN 125A</p>			
			
1			
código	560312	referencia	3120080
descripción	arandela int.ø 10.5mm ø ext. 20mm espesor 2mm inox UE 1 pzs DIN 125A para rosca M10		
Para modelos:	10CP1EA, 10CP1GA, 10CP1IA, 12CP1EA, 12CP1GA, 12CP1IA, 18CP2EA, 18CP2GA, 18CP2IA, BRE21HD, BRE31HD, FCV101-CSA, FCV101DM-CSA, FCV101DS-CSA, FCV101EDM-UL, FCV101EDS-UL, FCV101E-UL, FCV141-CSA, FCV141DM-CSA, FCV141DS-CSA, FCV241EDM-UL, FCV241EDS-UL, FCV241E-UL, FCV401DM-CSA, FCV401EDM-UL, FCV61-CSA, FCV61DM-CSA, FCV61DS-CSA, FCV61EDM-UL, FCV61EDS-UL, FCV61E-UL, FCV72EDS-UL, FCV72E-UL, PIER06HD, PIER10HD, PIER15HD		

			
1			
código	560113	referencia	3121480
descripción	arandela int.ø 6.4mm ø ext. 12mm espesor 1.6mm inox UE 20 pzs DIN 125A para rosca M6		
Para modelos:	030FE1, 30F1, 30FES2, 30FS2, 70F1, 70FE1, 70FES2, 70FES2B, 71F2, 71FE2, 91F210		

DIN 9021

			
1			
código	560210	referencia	3014810
descripción	arandela int.ø 11mm ø ext. 30mm espesor 2mm inox UE 1 pzs DIN 9021 para rosca M10		
Para modelos:	FC1011E, FC1011G, FC1221E, FC1221G, FC611E, FC611G, FM1011E1, FM1011E1-VERS.2006, FM1011E2, FM1011E2-VERS.2006, FM1011E3, FM1011E3-VERS.2006, FM1011G1, FM1011G1-VERS.2006, FM1011G2, FM1011G2-VERS.2006, FM1011G3, FM1011G3-VERS.2006, FM1221E1, FM1221E1-VERS.2006, FM1221E2, FM1221E2-VERS.2006, FM1221E3, FM1221E3-VERS.2006, FM1221G1, FM1221G1-VERS.2006, FM1221G2, FM1221G2-VERS.2006, FM1221G3, FM1221G3-VERS.2006, FM2011E2-VERS.2006, FM2011E3-VERS.2006, FM2011G2-VERS.2006, FM2011G3-VERS.2006, FM2021E1, FM2021E2, FM2021E2-VERS.2006, FM2021E3, FM2021E3-VERS.2006, FM2021G1, FM2021G2, FM2021G2-VERS.2006, FM2021G3, FM2021G3-VERS.2006, FM611E1, FM611E1-VERS.2006, FM611E2, FM611E2-VERS.2006, FM611E3, FM611E3-VERS.2006...(Otros modelos se puede ver en la tienda web)		

otros

			
1			
código	690687	referencia	36D2880
descripción	arandela		
Para modelos:	40, 40B, 40CP, 40CPX, 40PL, 40X, SA87		



 <p>imagen no disponible</p>			
código	691180	referencia	3120100
descripción	arandela		
Para modelos:	10CP1EA, 10CP1GA, 10CP1IA, 12CP1EA, 12CP1GA, 12CP1IA, 18CP2EA, 18CP2GA, 18CP2IA, C304AD, C304AS, C304AVD, C304AVS, CS370AD, CS370AS, CS370AVD, CS370AVS, CS466AD, CS466AS, CS466AVD, CS466AVS, FCV101DM, FCV101DM-CSA, FCV101DS, FCV101DS-CSA, FCV101EDM, FCV101EDM-UL, FCV101EDS, FCV101EDS-UL, FCV141DM, FCV141DM-CSA, FCV141DS, FCV141DS-CSA, FCV141EDM, FCV141EDS, FCV241DM, FCV241DS, FCV241EDM, FCV241EDM-UL, FCV241EDS, FCV241EDS-UL, FCV241GDM, FCV241GDM-CSA, FCV241GDS, FCV241GDS-CSA, FCV401DM, FCV401DM-CSA, FCV401EDM, FCV401EDM-UL, FCV4EDS...(Otros modelos se puede ver en la tienda web)		

			
código	506160	referencia	3120050
descripción	arandela int.ø 8.6mm ø ext. 16mm espesor 1.5mm inox UE 1 pzs		
Para modelos:	091FR1EX, 091FR7GS, 091FR7GX, BRE21HD, BRE31HD, FM1011E2-VERS.2006, FM1011E3-VERS.2006, FM1011G2-VERS.2006, FM1011G3-VERS.2006, FM1221E2-VERS.2006, FM1221E3-VERS.2006, FM1221G2-VERS.2006, FM1221G3-VERS.2006, FM611E2-VERS.2006, FM611E3-VERS.2006, FM611G2-VERS.2006, FM611G3-VERS.2006, FM721E3-VERS.2006, FM721G3-VERS.2006, FX101E2C, FX101E3C, FX101G2C, FX101G3C, FX10E2CR, FX10E3CR, FX10G2CR, FX10G3CR, FX122E2C, FX122E3, FX122E3C, FX122E3T, FX122E3T-VERS.022014, FX122G2C, FX122G3, FX122G3C, FX122G3T, FX122G3T-VERS.022014, FX12E3CT, FX12E3CT-VERS.022014, FX12G3CT, FX12G3CT-VERS.022014, FX61E2C, FX61E2CR, FX61E3CR, FX61G2C, FX61G2CR, FX61G3C, FX61G3CR, FX82E2C, FX82E3C...(Otros modelos se puede ver en la tienda web)		

			
código	520115	referencia	3140220
descripción	abrazadera de tubo ø 25-40mm ancho 9mm UE 10 pzs DIN 3017		

			
código	520119	referencia	3140200
descripción	abrazadera de tubo ø 60-80mm ancho 9mm UE 5 pzs DIN 3017		
Para modelos:	L100, L80, LP202, LP202HC, LP302, LP302HC, LP402, LP402HC, LP402V		

anillos truarc

DIN 6799

			
código	518557	referencia	3120460
descripción	anillo truarc E D1 ø 5mm D2 ø 11mm inox DIN 6799 espesor 0.7mm		
Para modelos:	04WFAAV, 04WVT1IV, 04WVT2IV, 08WFA4E, 08WFA4G, 08WFAAE, 08WFAAG, 08WFAAV, 08WVT1IV, 08WVT2IV, 090FAA, 091VT1I, 091VT2I, 0A0FA1, 0A0FA4, 0A0FAA, 0A1VT1I, 0A1VT2I, 0D0FA1, 0D0FA4, 0D0FAA, 0D1VT1I, 0D1VT2I, 0G0FA0, 12WFA6E, 12WFA6G, 12WFAAA, 12WFAAE, 12WFAAG, 12WFAAN, 190FA, 190FAA, 190FAB, 190FAD, 191FAAE, 191FAAG, 191FABG, 191FADG, 191FAE, 191FAG, 191VT1I, 191VT2I, 1A0FA1, 1A0FA2, 1A0FA4, 1A0FA5, 1A0FAA, 1A0FAB, 1A1FA1G, 1A1FA2G...(Otros modelos se puede ver en la tienda web)		

sujeciones

abrazaderas

abrazaderas de tubo

DIN 3017 - W2

			
código	520111	referencia	36E4320
descripción	abrazadera de tubo ø 10-16mm ancho 9mm UE 10 pzs DIN 3017		
Para modelos:	FM1011E2-VERS.2006, FM1011E3, FM1011E3-VERS.2006, FM1011G2-VERS.2006, FM1011G3, FM1011G3-VERS.2006, FM1221E2-VERS.2006, FM1221E3, FM1221E3-VERS.2006, FM1221G2-VERS.2006, FM1221G3, FM1221G3-VERS.2006, FM2011E2-VERS.2006, FM2011E3-VERS.2006, FM2011G2-VERS.2006, FM2011G3-VERS.2006, FM2021E2-VERS.2006, FM2021E3, FM2021E3-VERS.2006, FM2021G2-VERS.2006, FM2021G3, FM2021G3-VERS.2006, FM423E2, FM611E2-VERS.2006, FM611E3, FM611E3-VERS.2006, FM611G2-VERS.2006, FM611G3, FM611G3-VERS.2006, FM721E2-VERS.2006, FM721E3, FM721E3-VERS.2006, FM721G2-VERS.2006, FM721G3, FM721G3-VERS.2006		

pasadores elásticos

			
código	691398	referencia	31Z8930
descripción	pasador elástico ø 3mm L 16mm		
Para modelos:	0A0BMG, 0A0FT1G, 0A0FT2G, 0A0FT4G, 0A0FT5G, 0D0BMG, 0D0FT1G, 0D0FT2G, 0D0FT4G, 0D0FT5G, 1A0BMG, 1A0FT1G, 1A0FT2G, 1A0FT3G, 1A0FT4G, 1A0FT6G, 1A1BR1G, 1A1BR1GA, 1A1BR2G, 1A1BR2GA, 1A1FA1G, 1A1FA2G, 1A1FA4G, 1A1FA5G, 1A1FAS2G, 1A1FASG, 1A1TPOG, 1A1TPOG-VERS.2002, 1B1FAS2G, 1B1FASG, 1D0BMG, 1D0FT1G, 1D0FT2G, 1D0FT3G, 1D0FT4G, 1D0FT6G, 1D1BR1G, 1D1BR1GA, 1D1BR2G, 1D1BR2GA, 1D1FA1G, 1D1FA2G, 1D1FA4G, 1D1FA5G, 1D1FAS2G, 1D1FASG, 1D1TPOG, 1D1TPOG-VERS.2002, 2A1BR1G, 2A1BR1GA...(Otros modelos se puede ver en la tienda web)		

tapas roscadas



código	512516	referencia	3005450
descripción	tapa roscada rosca 1/2" rosca L 8mm inox UE 1 EC 17 espesor cabezal 4.5mm		
Para modelos:	FM1011E3, FM1011G3, FM1221E3, FM611E3, FM611G3, FM721E3, FM721G3		



código	358671	referencia	3200020
descripción	fusible fino medida ø5x20mm 1A rápido nominal 250V UE 10 pzs		
Para modelos:	06WBR3E, 0G1BR3E, 191BR1E, 191BR1GA, 191BR2E, 191BR2EA, 191BR2GA, 1A1BR1E, 1A1BR1GA, 1A1BR2E, 1A1BR2EA, 1A1BR2GA, 1D1BR1E, 1D1BR1GA, 1D1BR2E, 1D1BR2EA, 1D1BR2GA, 1G1BR3E, 291BR1E, 291BR1GA, 291BR2E, 291BR2EA, 291BR2GA, 2A1BR1E, 2A1BR1GA, 2A1BR2E, 2A1BR2EA, 2A1BR2GA, 2D1BR1E, 2D1BR1GA, 2D1BR2E, 2D1BR2EA, 2D1BR2GA, 71ARE, 91ARE, FCV401DM, FCV401EDM		

consumibles

pedras volcánicas/briquetas de cerámicas



código	211049	referencia	37T1320
descripción	briquetas de cerámica medida 50x50x26mm UE 40 piezas (2,4kg)		
Para modelos:	08WGRGV, 090GRG, 0A0GRG, 0D0GRG, 190GRG, 1A0GRG, 1D0GRG, 1G0GRG, 6042120-08WGRGV		

ø10x38mm 500V



código	358031	referencia	32V6210
descripción	fusible fino medida ø10x38mm 10A nominal 500V tipo Gg rápido UE 1 pzs		
Para modelos:	BX101E, BX101E-VERS.122013, BX122E, BX122E-VERS.122013, BX61E, BX61E-VERS.122013, BX82E, BX82E-VERS.122013, FC1011E, FC1221E, FC611E, FM1011E1, FM1011E1-VERS.2006, FM1011E2, FM1011E2-VERS.2006, FM1011E3, FM1011E3-VERS.2006, FM1221E1, FM1221E1-VERS.2006, FM1221E2, FM1221E2-VERS.2006, FM1221E3-VERS.2006, FM2011E2-VERS.2006, FM2011E3-VERS.2006, FM2021E1, FM2021E2, FM2021E2-VERS.2006, FM2021E3, FM2021E3-VERS.2006, FM611E1, FM611E1-VERS.2006, FM611E2, FM611E2-VERS.2006, FM611E3, FM611E3-VERS.2006, FM721E1, FM721E1-VERS.2006, FM721E2, FM721E2-VERS.2006, FM721E3, FM721E3-VERS.2006, FX101E1, FX101E1R, FX101E2, FX101E2C, FX101E2C-VERS.032014, FX101E2R, FX101E2R-VERS.032014, FX101E2-VERS.032014, FX101E3...(Otros modelos se puede ver en la tienda web)		

fusibles

fusibles finos



código	358668	referencia	3201540
descripción	fusible fino medida ø5x20mm 0.5A rápido nominal 250V UE 10 pzs		
Para modelos:	04WFR3ED, 08WFR4ED, 08WGREV, 091FR3ED, 0A1FR1ED, 0A1FR3ED, 0D1FR1ED, 0D1FR3ED, 0G0FR3ED, 10CP1EA, 10CP1GA, 10CP1IA, 12CP1EA, 12CP1GA, 12CP1IA, 18CP2EA, 18CP2GA, 18CP2IA, 191FR4ED, 1A1FR2ED, 1A1FR4ED, 1D1FR2ED, 1D1FR4ED, 71RA, 91RA, FC101, FC1011E, FC1011G, FC101E, FC1221E, FC1221G, FC241, FC241E, FC241G, FC61, FC611E, FC611G, FC61E, FCV101, FCV101DM, FCV101DS, FCV101E, FCV101EDM, FCV101EDS, FCV141, FCV141DM, FCV141DS, FCV141E, FCV141EDM, FCV141EDS...(Otros modelos se puede ver en la tienda web)		

A			
abrazaderas	298, 303		
abrazaderas de tubo	298, 303		
accesorios eléctricos	111		
accesorios para lámparas	55		
anillos de junta	273		
anillos truarc	303		
aparatos de mando y aviso	45		
arandelas	302		
arandelas elásticas	302		
B			
bandas de bisagras	234		
bisagras de resorte	234		
bisagras para hornos	236		
bombas	101		
bombas de aumento de presión I	108		
bombas de lavado y aclarado	101		
bombas de salida	108		
bombas de vibración	109		
bombas para máquinas de cubitos de hielo	109		
bombillas incandescentes	50		
boquillas de gas	165		
boquillas dobles	290		
C			
cables	111		
cables de calefacción	8		
cables de cinta plana	112		
cables de encendido	145		
cables de enlace	112		
cables de tierra	111		
cartuchos calentadores	9		
centralitas de gas automáticas	133		
cierres angulares	232		
cierres de enganche	232		
cierres de palanca	232		
cierres de palanca pivotante	226		
cierres de pestillo espagnolette	233		
clips para bulbo	34		
componentes para el circuito agua	298		
componentes para el circuito frigorífico	277		
compresores	89		
condensadores de arranque	109		
condensadores de servicio	110		
condensadores y filtros antiparasitarios	109		
conectores enchufables	112, 112		
conmutadores de levas	41		
conmutadores giratorios	43		
consumibles	304		
contactores	60		
controladores electrónicos	65		
		cubetas de evaporación con resistencia	91
D			
		dosificadores	283
		duchas de mano con rosca macho	282
		duchas de mano para lavado	282
E			
		empalmes de tubo	291
		empalmes de tubos	289
		encendedores piezoeléctricos	146
		evaporadores	278
		extractora	299
F			
		filtros	110
		filtros de entrada	298, 298
		filtros deshidratadores antiácidos	277
		filtros de recipientes	286
		fusibles	111, 304
		fusibles finos	304
G			
		gastro-norm	282
		grifos de gas	114
		guarniciones	290
H			
		herramientas	299
		herramientas de mano	299
I			
		interruptores de flotador	41
		interruptores de sistema ROLD	40
		interruptores magnéticos	44
		interruptores posicionales	40
		interruptores pulsantes y pulsadores	35
		interruptores y pulsadores	35
		interruptores/pulsadores basculantes	35
J			
		juntas de árbol	275
		juntas de gomaespuma	275
		juntas de puerta para lavavajillas	276
		juntas de termostato	277
		juntas insertables	258
		juntas para bandejeros	269
		juntas para frigoríficos	258
		juntas para puertas	265
		juntas para ventanas	264
		juntas patra brazos de lavado	277
		juntas roscadas	263
		juntas térmicas	264

juntas tóricas	269	resistencias para salamandras / tostadores de pan	8
L		resistencias para sartenes basculantes	7
lámparas	48	resistencias radiantes	17
lámparas de señalización	48	retén	232
lámparas de señalización completas	48	S	
lámparas halógenas	51	señalizadores de alarma	60
lámparas para hornos	51	sensores	69
lámparas para neveras	51	sensores universales	69
M		sistemas de medición	299
material de sujeción	300	sondas de temperatura	69
microinterruptores	37	sopletes	164
motores de aire caliente	96	sujeciones	303
motores refrigeración universales	92	T	
P		tapas roscadas	304
parrillas	254	tecnología de bebida	297
pasadores elásticos	303	temporizador de descongelación	59
piedras volcánicas/briquetas de cerámicas	181, 304	temporizadores	55
pilotos de encendido	134	temporizadores de programa	55
pinzas	34	temporizadores mecánicos	59
placas de cocción	18	terminales	112
presostatos	86	terminales de cable y conectores	112
Q		termopares	148
quemadores de cocina	151	termostatos	19
quemadores de gas	151	termostatos de regulación	20, 30
quemadores para placas radiantes	164	termostatos de seguridad	23, 31
quemadores tubulares	161, 164	termostatos de superficie	19, 20
R		termostatos de superficie de seguridad	19
racores de tubo flexible	286	termostatos para frío	32
reducciones	290	termostatos para gas	120
reductores de presión	298, 298	tornillos	300
registros de calefacción	9	tornillos de cabeza avellanada	300
reguladores de energía	19	tornillos de cabeza moleteada	300
rejillas y rieles guía	254	tornillos prisioneros	300
relés	63	transformadores	64
resistencias	3	tuberías de gas	180
resistencias circulación de aire	16	tubos de entrada	296
resistencias de descongelación	7	tubos de presostato	287
resistencias de inmersión	10	tubos de salida	287
resistencias de tubo de aletas	9	tubos flexibles	287
resistencias fry top	8	tubos flexibles de entrada	287
resistencias para baño maría	4	tubos flexibles de entrada de PVC	287
resistencias para cuecepastas	7	tubos flexibles industriales	287
resistencias para freidora	5	tubos flexibles PU	288
resistencias para hornos	3	tubos formados	288
resistencias para plancha grills	6	tubos Niplaflex	287
resistencias para refrigeración	7	tuercas	301
resistencias para repisas infrarrojos	8	tuercas de mariposa	301
		tuercas de racor	302
		tuercas hexagonales	300, 301
		tuercas moleteadas	301

U

unidades de encendido 147

V

válvulas 297

válvulas de bola 293

válvulas de cierre 294

válvulas de control de gas 129

válvulas de entrada 296

válvulas de expansión 277

válvulas de retención 297

válvulas de seguridad 134

válvulas de vapor 296

válvulas magnéticas 77

válvulas magnéticas de gas 134

válvulas y caños de pared 293

ventilador axial 91

ventiladores 91

ventiladores de aire caliente 100

ventiladores de refrigeración 95

ventiladores para frigoríficos 92

ventiladores radiales 100

ventiladores tangenciales 95